

Radiation and Health

by
Thormod Henriksen
and
Biophysics group at UiO

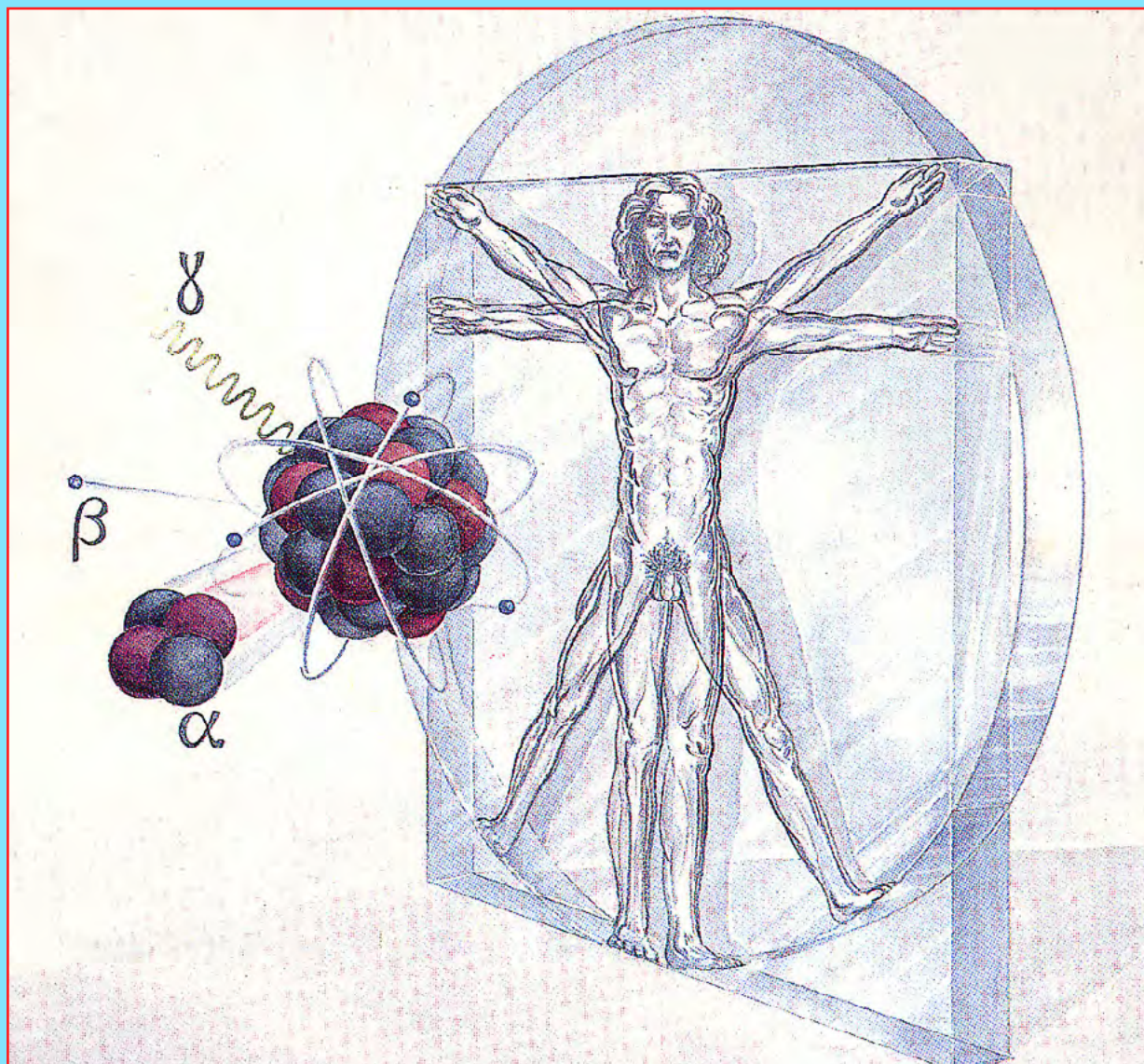

Preface

The present book is an update and extension of three previous books from groups of scientists at the University of Oslo. The books are:

I. Radioaktivitet – Stråling – Helse

Written by; Thormod Henriksen, Finn Ingebretsen, Anders Storruste and Erling Stranden.

Universitetsforlaget AS 1987

ISBN 82-00-03339-2

I would like to thank my coauthors for all discussions and for all the data used in this book. The book was released only a few months after the Chernobyl accident.



II. Stråling og Helse

Written by Thormod Henriksen, Finn Ingebretsen, Anders Storruste, Terje Strand, Tove Svendby and Per Wethe.

Institute of Physics, University of Oslo 1993 and 1995

ISBN 82-992073-2-0

This book was an update of the book above. It has been used in several courses at The University of Oslo. Furthermore, the book was again updated in 1998 and published on the Internet.

The address is: <http://www.mn.uio.no/fysikk/tjenester/kunnskap/straling/>

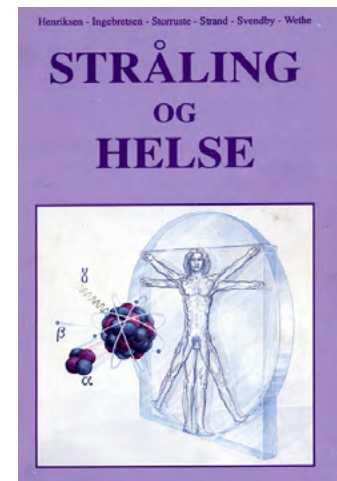

III. Radiation and Health

Written by Thormod Henriksen and H. David Maillie

Taylor & Francis 2003

ISBN 0-415-27162-2

This English written book was mainly a translation from the books above. I would like to take this opportunity to thank David for all help with the translation.

The three books concentrated to a large extent on the basic properties of ionizing radiation. Efforts were made to describe the background radiation as well as the release of radioactivity from reactor accidents and fallout from nuclear explosions in the atmosphere. These subjects were of high interest in the aftermath of the Chernobyl accident.

During the later years a large amount of research and interesting new results within radiobiology have emerged. The purpose of the present book is therefore to include some interesting applications of radiation in medicine, as well as to present some of the exciting new discoveries in radiobiology.

In this update the basic radiation physics and radiobiology are included. Furthermore, some applications of radiation in medicine will be highlighted.



It would be impossible to embark on this project unless heavy support from my active colleagues at the “group of Biophysics and Medical physics” at The University of Oslo. The group is engaged in research with the aim to attain information about the physical processes taking place in cells and tissue when irradiated. This include the formation of radicals and how they lead to the known biological endpoints. The group members (professors Eli Olaug Hole and Einar Sagstuen) are using magnetic resonance (ESR) to study radical formation, secondary processes and fate.

Other members of the group (professor Erik Pettersen) are using mammalian cells in culture. The interests are the control mechanisms working in the cell cycle. Of particular interest is the effect of small radiation doses, given at a low dose rate. These studies are of importance for environmental problems as well as within cancer treatment.

The group have close cooperations with professor Eirik Malinen (radiation therapy) and associate professor Hilde Olerud (diagnostic).

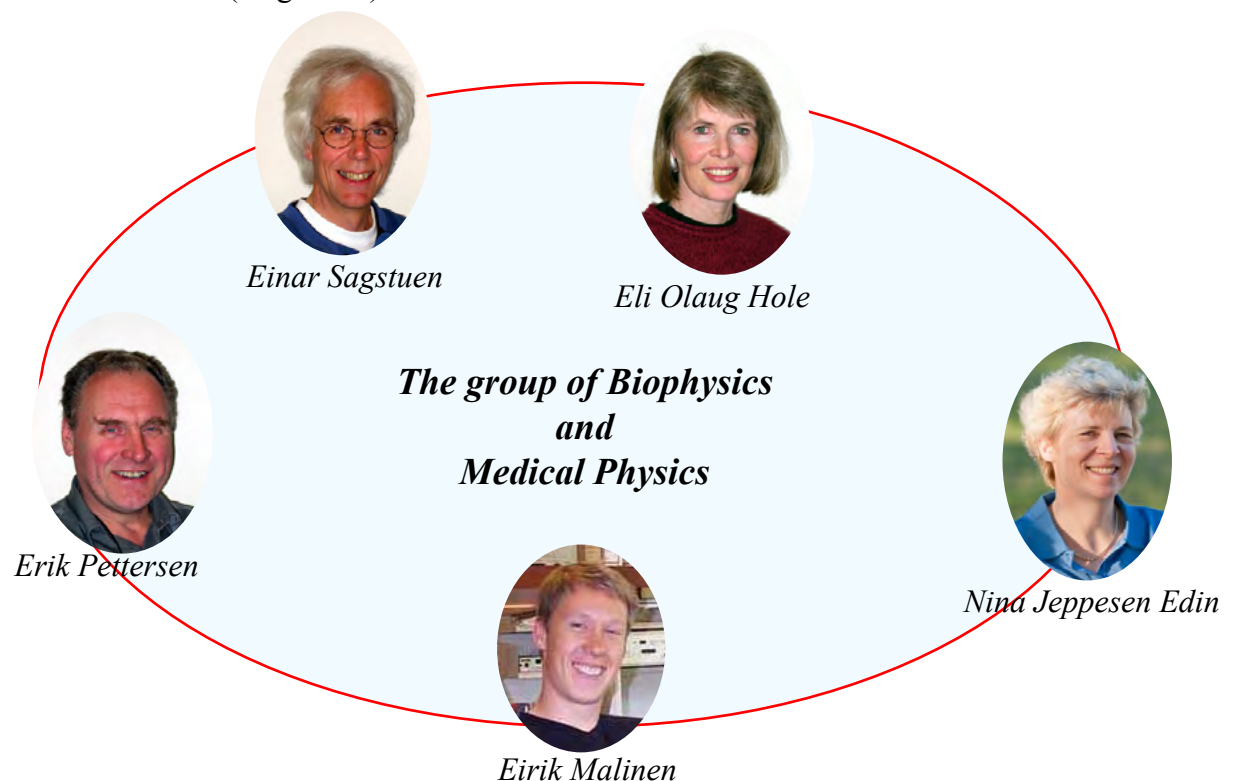

I take this opportunity to thank all my coworkers with the previous books as well as the members of the biophysics group with the present book, which is free to everybody here on Internet.

In order to discuss some results and models I have used illustrations published on Internet without further permission.

University of Oslo, 2009
Updated 2013

Thormod Henriksen



Contents

Chapter 1. Radiation is discovered

page 6 –12



Chapter 2. What is radioactivity

page 13 – 34



Chapter 3. Radioactive decay laws

page 35 – 42

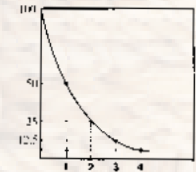

Chapter 4. Artificial radioactive isotopes

page 43 – 52



Chapter 5. Activity and dose

page 53 – 65



Chapter 6. The measurement of radiation

page 66 – 83

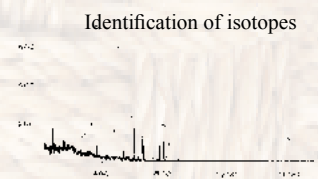

Chapter 7. The Natural Radiation Sources and doses to the people

page 84 – 123

Chapter 8. Nuclear weapons – Reactor accidents and pollution

page 124 – 171



Chapter 9. Radiation used for diagnostic purposes
214

page 172 –

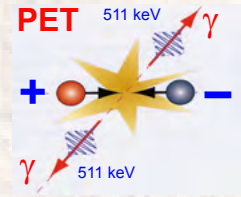

Chapter 10. Radiation used for therapy – radiation therapy page 215 – 227



Chapter 11. Radiation Damage to Biomolecules — From water to DNA 228 – 245

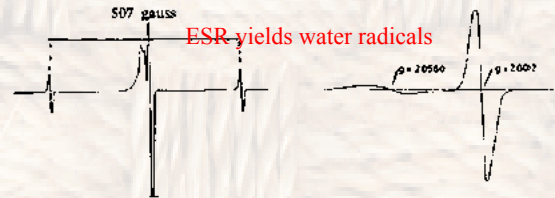

Chapter 12. Cellular radiation damage and repair

page 246 – 263

Chapter 13. Radiation and health – Cancer

page 264 – 287

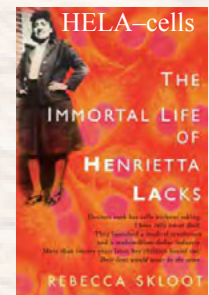

Chapter 14. Nuclear power – Environment – Climate

page 288 – 301

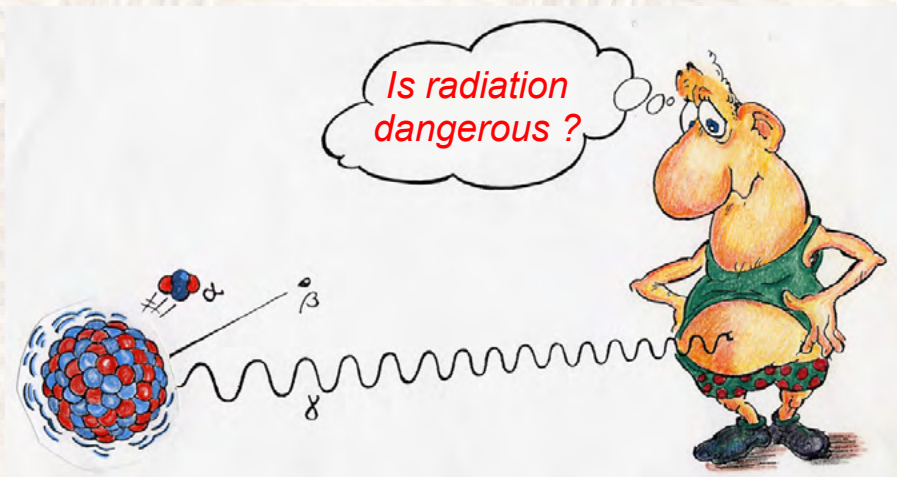

It would be impossible to run a hospital without extensive use of radiation.

Chapter 1

Radiation is Discovered

Introduction

From the beginning of life on earth, all living things have been exposed to radiation. Life started and developed in spite of, or possibly because of, radiation. It is disquieting to people that they coexist with radiation yet it cannot be seen, heard or felt.

Radiation, when broadly defined, includes the entire spectrum of electromagnetic waves: radio waves, microwaves, infrared, visible light, ultraviolet, x-rays and atomic particles. In this book we are concerned with radiation having energies high enough to ionize matter. Examples are x-rays, cosmic rays, and the emissions from radioactive elements. Although the term “ionizing radiation” is in this case more precise, common usage often omits “ionizing” and this is what is done here. In this book, “radiation” means “ionizing radiation.”

Prior to the reactor accidents at Three Mile Island in the United States (1979) and at Chernobyl in the former Soviet Union (1986), radiation issues were addressed primarily by specialists. Now, however, radiation and biological effects are debated by the public and political leaders. They use expressions such as: radiation dose, becquerel, gray, cesium and γ -radiation. Because people are easily confused by this technical language, all too often they are left with the perception that *all* uses of radiation are dangerous.

This book is written for those who want to understand radiation in order to make informed decisions about it in their lives. This field of science, founded at the turn of the century, has provided dramatic insights into physics, chemistry, biology, and medicine. The work of the early investigators provided a strong foundation from which to understand radiation phenomena. We will meet a few of them in the following pages and gain insight into their work and lives.

<p style="text-align: center;"><u>X-rays</u> discovered November 1895</p> <p>This radiation is man-made. We have developed a variety of x-ray equipments. The radiation exists only as long as the x-ray machine is turned on.</p>	<p style="text-align: center;"><u>Radioactivity</u> discovered March 1896</p> <p>Both natural and man-made radioactivity exists. The sources emit radiation all the time – you can not turn them on and off.</p>
--	--

X-rays

X-rays were discovered by Wilhelm Conrad Roentgen at the University of Würtzburg in Germany. He, like many others in those days, was studying electric discharges in glass tubes filled with various gases at very low pressures. In experiments on November 8, 1895, Roentgen had covered the tube with some black paper and had darkened the room. He then discovered that a piece of paper painted with a fluorescent dye, at some distance from the tube, would glow when he turned on the high voltage between the electrodes in the tube. Realizing the importance of his discovery, Roentgen focused all his attention on the study of this new radiation that had the unusual property of passing through black paper. He found that the radiation not only could penetrate black paper but also thick blocks of wood, books and even his hand. In the dark room, he observed shadows of the bones in his own hand. This was the first x-ray image. The German anatomist von Koelliker (see his hand below) proposed that the new type of radiation be called *Roentgen rays*. Although this term is used in many countries, the most common name used is that coined by Roentgen himself, "x-rays". The letter "x" is often used by physicists to indicate something "unknown." Since the nature of these rays was unknown, Roentgen called them x-rays.

X-rays on earth are from man-made sources. There are x-rays from natural sources in outer space. They are, however, absorbed by the upper atmosphere and do not reach the earth's surface.



W. C. Roentgen
(1845 - 1923)

Roentgen discovered x-rays in the fall of 1895. He immediately understood that the radiation from the x-ray tube had special properties, for example, it was possible to "see into" a human body. Within months this new radiation, called x-rays, was used in medical diagnostics.

It was realized that x-rays also could kill living cells, and that the sensitivity for killing varied from one cell type to another. Consequently, x-rays could be used in cancer therapy.

The unit R (roentgen) used for radiation exposure was named after Roentgen. An exposure of 1 R means that the radiation dose to ordinary tissue is approximately 9.3 mGy (see later).

Nobel prize in Physics 1901

To Wilhelm Conrad Roentgen
"In recognition of the extraordinary services he has rendered by the discovery of the remarkable rays subsequently named after him".

This was the very first Nobel Prize.



This x-ray picture was taken by Roentgen in January 1896. It is the hand of von Koelliker who suggested the name Roentgen rays.

What is X-rays?

In order to produce x-rays you must have equipment like that shown in the drawing. It consists of an evacuated glass tube with two electrodes and a high voltage between the electrodes. The cathode is heated and electrons are emitted. They have a negative charge and is accelerated towards the positive electrode (the anode). The larger the voltage between the electrodes the higher speed and energy will the electrons attain.

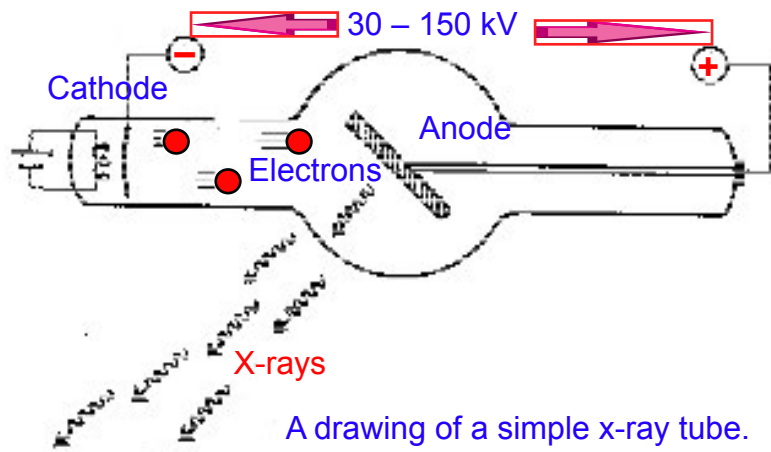

The fast electrons smash into the anode which is made of tungsten or another heavy metal. The electrons are stopped and lose their energy. Most of the energy is transformed into heat in the anode (which is cooled with water), and a small part is transformed into radiation – x-rays!

The part of energy that is transformed into radiation varies from zero up to the maximum energy of the electron when it hits the anode. This implies that the x-ray photons from the tube have a number of different energies – in fact a whole spectrum. Due to the mechanism for the formation we sometimes call this radiation for “*bremstrahlung*” (from the German word for brake or stop).

X-rays are usually described by their maximum energy, which is determined by the voltage between the electrodes. It may range from about 20 kV up to 300 kV. Radiation with low voltage is called “*soft*” – and radiation with high voltage is called “*hard*”. We shall return to this in combination with the use of x-rays in medicine.

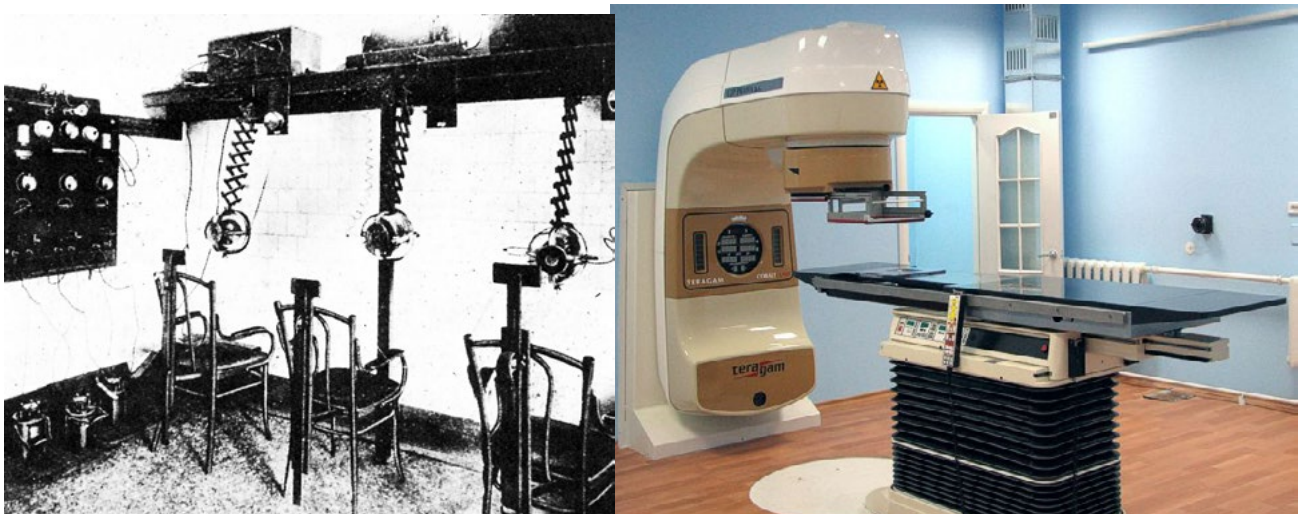

Here you can see some of the progress that has taken place during the last 100 years. Both pictures show equipment for radiation therapy for cancer. To the left is shown equipment from 1903, designed to treat 3 patients simultaneously.

The mysterious x-rays

In the first period after the discovery of x-rays many people had a number of strange ideas as to what x-rays really are, and how they could be used. Here are a couple of examples of what one could see in the newspapers and magazines at that time.

The examples are taken from the book of R. F. Mould “*A Century of X-Rays and Radioactivity in Medicine: With Emphasis on Photographic Records of the Early Years*” (1993)



The newspapers very often had headlines such as; *Electric Photography Through Solid Bodies* and *Photography of Unseen Substances*.

The drawing to the left is from *Life* magazine, February 1896.

The picture shows a common misunderstanding. Some people believed that it was possible to take x-ray pictures with reflected x-rays. This means that both the x-ray tube and film is in the photographer's box, as shown. This is wrong, the source and detector must be on opposite side of the object. The x-rays must penetrate the body and hit a detector (e.g. a film) on the other side.

Note added 2009

Both these two cartoons which resulted in a big smile a few years ago is today a reality. In Chapter 9 we shall learn about “backscattered x-ray technique”. In a Compton process an x-ray photon may be scattered 180 degrees and it is possible to obtain a picture – and in fact see a naked person. This technique is in use for security at some air ports (see Chapter 9).

In the first period after the discovery of x-rays, people had a lot of ideas of what you could see, for example, through clothes. Some rumors said it was possible to watch people when they changed into swimming suits inside the small cabins on the beach. It is, therefore, not so surprising that a London tailor company advertised that they could make *x-ray proof underclothing for ladies*.

The drawing to the right was used as an advertisement for x-ray proof underwear.

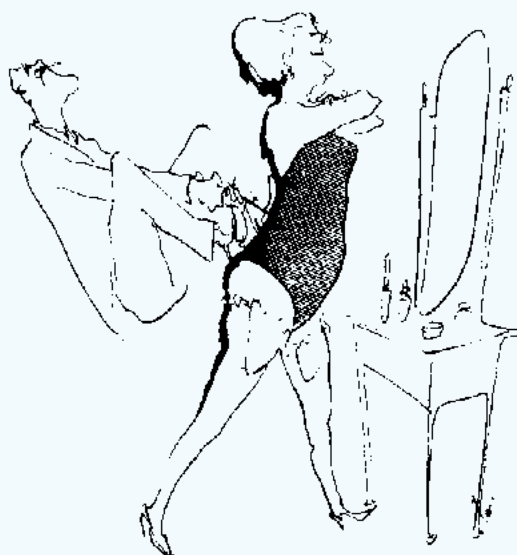

To the left: The Physical Institute in Würzburg in 1896. Here was Roentgen's laboratory when he discovered the x-rays. Today this laboratory is a museum.

X-ray celebration and wine bottles

In the fall of 1995 a large international conference was held in Würtzburg, Germany where the 100 year anniversary of Roentgens discovery was celebrated. A wine bottle, with the picture of Roentgen, was made – and served at the reception. The text you can see around the picture of Roentgen is:

“1995 . Vor 100 Jahren entdeckte Conrad Wilhelm Röntgen eine neue art von Strahlen”



Radioactivity

Ionizing radiation can neither be seen nor felt. It is therefore a challenge just to know whether it is present or not. The situation is the same for radio and TV signals; you can not see or feel them. But if you have a radio tuned to the correct frequency, it will detect the presence of the radio signal. Similarly, in order to detect ionizing radiation, a special detector or sensor is needed.

The French physicist Henri Becquerel was using a photographic plate when he discovered radioactivity in the spring of 1896. Becquerel was 44 years old and was working with compounds that could emit light after being exposed to sunlight. The light (called fluorescence) from the exposed samples was then detected by these photographic plates.

Becquerel had a compound – a uranium salt, in one of his desk drawers. When exposed to sunlight the uranium salt emitted fluorescence. During a period of cloudy weather in Paris, Becquerel was unable to carry out his usual experiments involving fluorescence induced by sunlight. Instead, he decided to check for any possible light leaks by developing some of his unexposed photographic plates. To his surprise, he found that a plate on top of the uranium salt was black. Somehow, intense radiation had exposed the plate. Becquerel was puzzled at first then realized that some unknown type of radiation had to be emanated from the uranium salt - *radioactivity was discovered*.

Marie Sklodowska Curie and her husband Pierre Curie managed to isolate the radioactive materials from the parent rocks. After a large amount of work, they isolated two radioactive elements. The first one was called *polonium* (after Marie's homeland Poland), and the other one was called *radium* (which is "the thing that radiates"). Marie Curie died in 1934 from a blood disease, possibly leukemia, which may have been caused by her work. She became 67 years old.

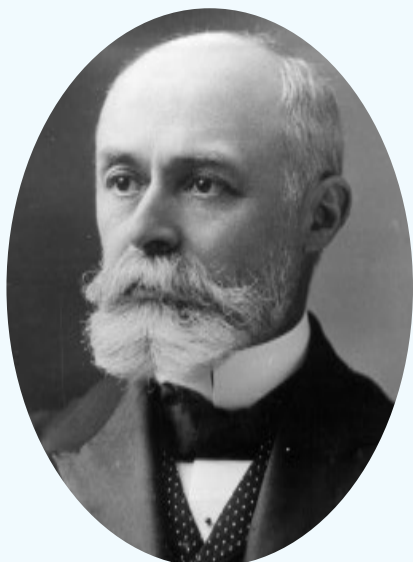

Henri Becquerel
(1852 – 1908)

Becquerel was French, a third generation professor of physics. His father, Alexander Edmond Becquerel, was a Professor of Applied Physics and had done research on solar radiation and on phosphorescence. His grandfather, Antoine César Becquerel was the inventor of an electrolytic method for extracting metals from their ores.

Henri Becquerel's earliest work was concerned with the plane polarization of light, with the phenomenon of phosphorescence and with the absorption of light by crystals. On March 2nd of 1896 Henri discovered radioactivity. For this discovery, he was awarded the Nobel prize in Physics, together with the Curies, in 1903.

The unit for the intensity of a radioactive source is named after Becquerel. Thus, 1 becquerel (abbreviated Bq) indicates that, on average, one atom in the source disintegrates per second.

The Nobel Prize in Physics 1903

To Henri Becquerel.

"In recognition of the extraordinary services he has rendered by his discovery of spontaneous radioactivity".

To Marie Sklodowska Curie and Pierre Curie.

"In recognition of the extraordinary services they have rendered by their joint researches on the radiation phenomena discovered by Professor Henri Becquerel".

The Curie Family



Marie Sklodowska Curie
(1867 – 1934)

Curie is a prominent name in radiation science. For their work, the Curies won 3 Nobel prizes.

Marie and Pierre shared the prize in physics with Becquerel in 1903.

Marie got the prize in chemistry in 1911, and finally, their daughter Irene won the prize in chemistry in 1935 together with her husband Frederic Joliot.

Nobel Prize in Chemistry 1911

To Marie Curie.

"In recognition of her services to the advancement of chemistry by the discovery of the elements radium and polonium, by the isolation of radium and the study of the nature and compounds of this remarkable element".



© UK Science Museum/Science & Society Picture Library

The nice picture to the left is taken around 1903 when Marie and Pierre were awarded the first Nobel prize. The couple got two daughters Irene which is seen in the picture, and Ève Denise born in 1904 and died in 2007 – almost 103 years old.

Marie Curie (1867 - 1934) came from Poland and her name was Sklodowska before she married Pierre Curie in 1895. Marie was very gifted and worked all her life with radioactive compounds. She discovered the elements radium and polonium, the latter being named after her homeland. It was the purification of radium that earned her the Nobel prize in chemistry. She is the only person who has ever won the Nobel prize in both physics and chemistry.

Pierre Curie (1859 - 1906) worked with radioactive compounds together with Marie. However, Pierre is also well known for his work in magnetism. Named after him we have “the Curie point”, “Curie’s law” and “the Curie constant”.

Pierre was only 47 years old when he died in a traffic accident (involving a horse drawn carriage) in Paris in 1906.



Irene Joliot-Curie
(1897 – 1956)



Frederic Joliot-Curie
(1900 – 1958)

Frederic Joliot became an assistant to Marie Curie in 1925. He fell in love with Irène Curie, and they married in 1926. They both took the name Joliot-Curie.

Irene Joliot Curie (1897 - 1956) was the oldest of the two girls in the Curie family. She became a physicist and married:

Frederic Joliot (1900 - 1958). Together they discovered man-made radioactivity in 1934. By bombarding aluminum with α -particles, they produced a radioactive isotope of phosphorus, P-30.

The Nobel Prize in Chemistry 1935

To Irene Joliot Curie and Frederic Joliot
“In recognition of their synthesis of new radioactive elements”

Chapter 2

What is Radioactivity?

Radioactive Elements

The atomic structure of most elements contains a nucleus that is stable. Under normal conditions, these elements remain unchanged indefinitely. They are not radioactive. Radioactive elements, in contrast, contain a nucleus that is **unstable**.

The unstable nucleus is actually in an excited state that can not be sustained indefinitely; it must relax, or *decay*, to a more stable configuration. Decay occurs spontaneously and transforms the nucleus from a high energy configuration to one that is lower in energy. This can only happen if the nucleus releases energy. The energy is emitted by the relaxing nucleus as radiation. All radioactive elements have unstable nuclei; that is what makes them radioactive.

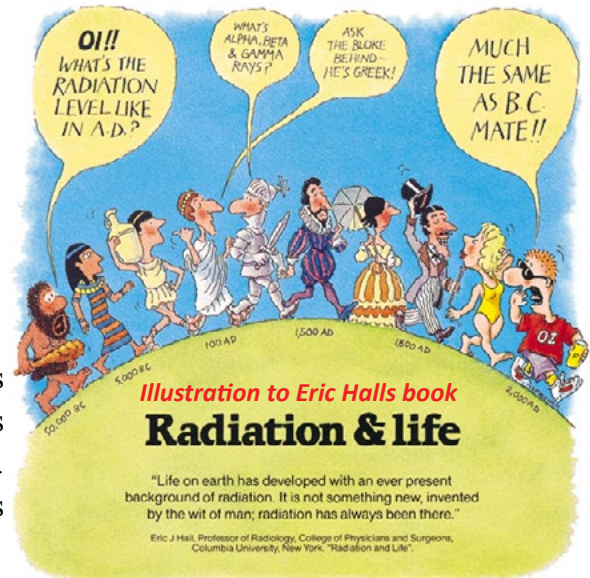

The Nature of Radiation

The energy emitted by an unstable nucleus comes packaged in very specific forms. In the years that followed the discovery of radioactivity, it was of great interest to determine the kind of radiation emitted from the different radioactive compounds. It was found that the radiations in general consisted of three types called: alpha (α), beta (β) and gamma (γ) radiations after the first three letters in the Greek alphabet (see figure below).

The radiation emitted transforms the element into a new element. The process is called a decay or a *disintegration*.

The research leading to the identification of the radiation emitted from the radioactive atoms is exciting and fundamental. We shall give you a glimpse of this work.

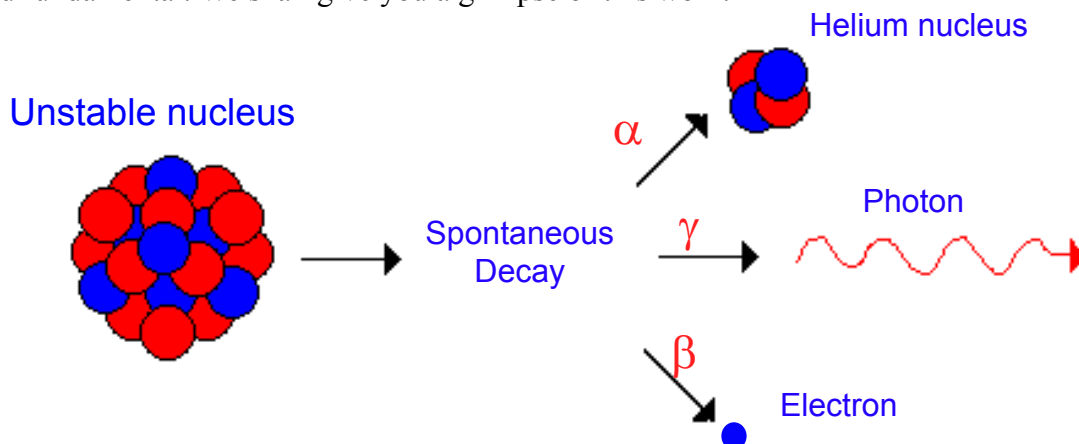

A radioactive atom possesses an unstable nucleus. This means that radioactive atoms will emit radiation sooner or later and by this convert into a more stable state. The types of radiation that may be emitted are called alpha (α), beta (β) and gamma (γ) radiation. Later we shall see some more exotic ways of disintegration.

Evidence for the three types of radiation comes from experiments in which the radiation from radioactive compounds passed through magnetic and/or electric fields. The illustration to the right demonstrates this point.

γ -rays passed through the field without disturbance, whereas the two other types were deflected from a straight line. This shows that γ -rays have no charge while α - and β -radiations consist of charged particles. The α -particles are positive whereas the β -particles, deflected in the opposite direction, are negative. We shall return to special sources where positive electrons (*positrons*) are emitted).

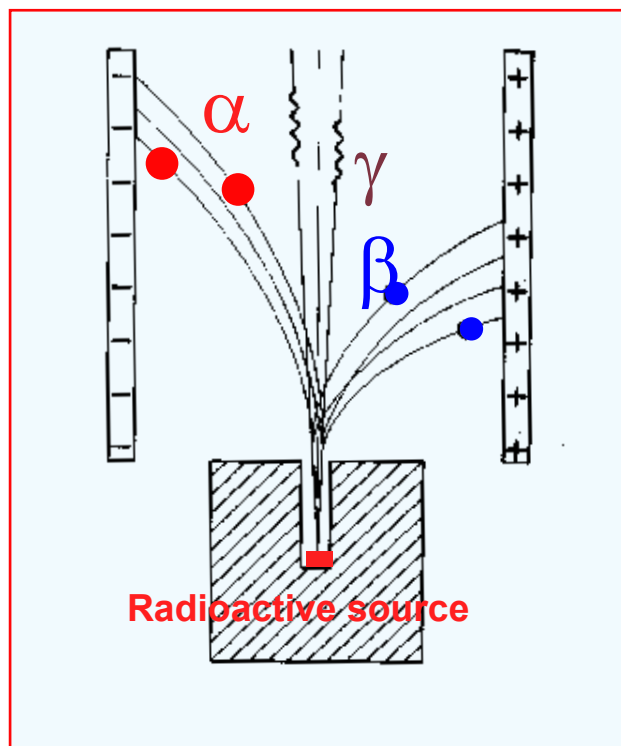

Some details on the nature of the radiation from radioactive sources

We shall give you some information about the radiation from the different radioactive nuclei. Such information is necessary in order to use radioactive sources in medicine and industry as well as for calculation of doses. All the details are gathered in the so called “*decay scheme*” for a radioactive isotope. Some examples will be given.

Alpha-radiation

Intensive research was going on in the years around 1900 to determine that the α -particle was the nucleus of helium. A radioactive source that emits α -particles is called an α -emitter. Many of the natural sources consisting of heavy elements, like radium and thorium are α -emitters (see illustration).

${}^{226}_{88}\text{Ra}$

Upper number = atomic weight
Lower number = atomic number

Radium – 226
Unstable

Radon – 222
Unstable

α -particle

Radium (atomic number 88) has an unstable nucleus weighing 226 atomic units. It decays by emitting an α -particle and becomes a new element **Radon**, written Rn-222 (atomic number 86) weighing 222 atomic units. Rn-222 is however, unstable and will in turn decay into polonium, Po-218.

It was Ernest Rutherford (considered as the father of nuclear physics) that finally could conclude that the α -particle was the nucleus of the helium atom. We would like to share with you this elegant experiment from 1908.

Rutherford positioned one glass tube inside a second glass tube. The inner tube contained a radioactive source that emitted α -particles (figure below). The outer tube was evacuated and at each end there was an electrode. The α -particles passed through a thin window and entered the outer tube as a gas.

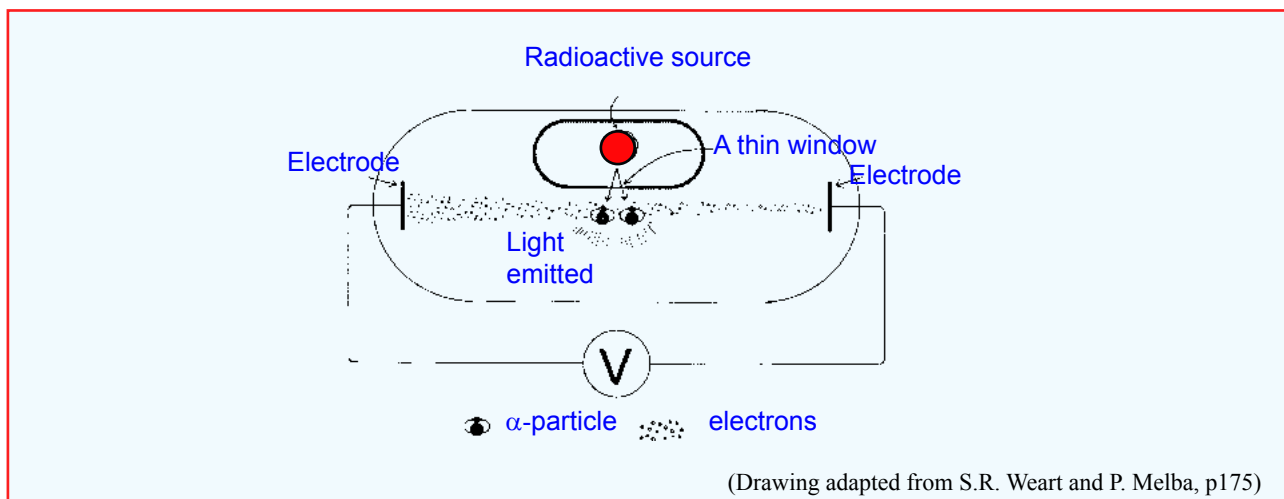

A drawing of Rutherford's experiment. α -particles from a radioactive source pass through a thin window into an evacuated glass tube. The α -particles "pick up" electrons and become ordinary helium atoms. The color of the emitted light confirmed that the glass tube became filled with helium.

When Rutherford turned on the high voltage between the electrodes, the tube emitted light at very specific wavelengths (specific colors). He compared wavelengths of this light with the wavelengths of light produced by a similar tube that he had filled with helium gas. The colors of the light were identical. Rutherford concluded that an α -particle is simply the nucleus of a helium atom and that when the α -particles reach the outermost tube they have picked up two electrons to become helium atoms.

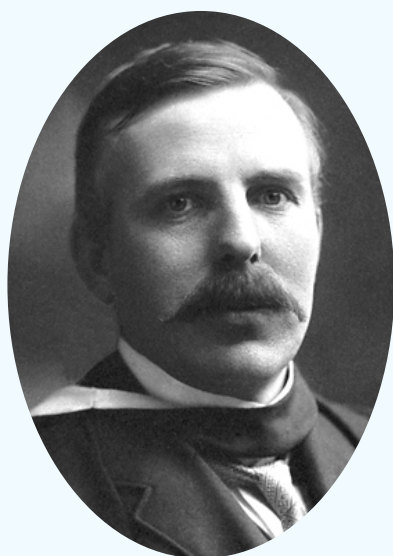

Ernest Rutherford
(1871 – 1937)

Ernest Rutherford was born in New Zealand. He was a research student at the Cavendish Laboratory in England and became professor at McGill University in Montreal in 1898. Rutherford returned to England in 1907 and was Professor of Physics in Manchester, and finally at the Cavendish laboratory in Cambridge. Rutherford introduced a new atom model after his well-known "gold foil experiment" in which he demonstrated that the atom has a tiny, massive nucleus.

For his magnificent work with radioactivity in these early years he was awarded the Nobel prize in chemistry in 1908.

Summary on α -particles

An α -particle is the nucleus of helium. It has a charge of +2 and a weight of 4 atomic mass units. The “mother” nucleus (M) is changed into a “daughter” nucleus (D) according to the following reaction:

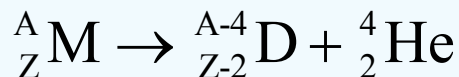

A = atomic mass (the number of protons and neutrons).
Z = atomic number (the number of protons).

The emitted α -particles all have the same energy, or are distributed in a few mono-energetic groups. The energy is high – ranging from 1.5 MeV to about 11 MeV.

Almost all α -particle sources are found among the heavy elements and most of them are natural.

The daughter nucleus is very often unstable – and most often emits γ -radiation. We can notice that the γ -radiation comes from the unstable daughter nucleus.

Beta-radiation

An unstable nucleus may attain a more stable configuration by emitting a β -particle. In this process a neutron in the nucleus is transformed into a proton and an electron (see illustration).

Due to the difference in mass, we can consider a neutron to be a proton + an electron + a small sub-atomic particle (the *neutrino*).

Both natural sources and artificial radioactive sources may be β -particle emitters. The energy of the emitted β -particle is usually much smaller than that of the α -particles.

Furthermore, the energy of the β -particles varies from one disintegration to another!

In fact β -particle emission involves a whole spectrum of energies. The reason for this situation is that together with the β -particle, a tiny neutral particle is emitted. This particle was named the “*neutrino*” by the Italian physicist Enrico Fermi. (The term neutrino means a “small neutral particle”). The β -particle emission is written:

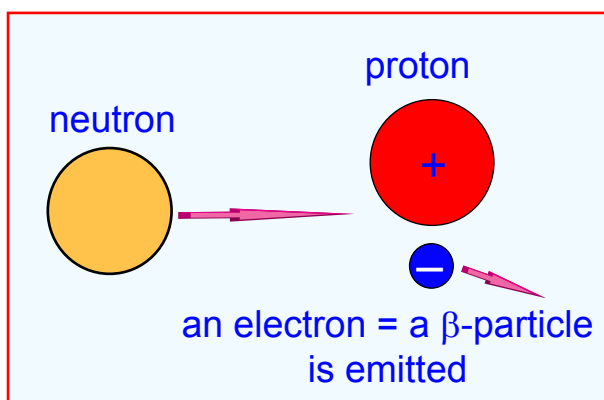

The mass A is unchanged.

The proton number (Z) increases by one.

The kinetic energy of the β -particle and the neutrino combined is constant. The energy of the β -particle alone, varies from zero up to a maximum value – equal to the constant. The average energy of the β -particle is about 1/3 of this maximum energy.



The average β -particle energy : rule of thumb.

The β -particle energy for a source varies from zero up to a maximum value.

The average energy is approximately 1/3 of the maximum energy.

Proton changes into a neutron

In the case of β -decay, we described this reaction as a transformation of a neutron in the nucleus into a proton and an electron, which in turn was emitted. This may be a favorable reaction since the neutron mass is larger than the proton mass. The opposite reaction would be that a proton is transformed into a neutron. This process may take place via two different routes – electron capture and positron emission.

Electron capture

This is a decay process whereby an orbital electron (mainly a K-electron) is captured by the nucleus and together with a proton is transformed into a neutron. The nucleus with atomic number Z is transformed into a new one with atomic number $Z - 1$, whereas the mass is unchanged. This reaction is usually followed by γ -radiation, and some characteristic x-radiation (the orbital hole is filled by electrons from the outer orbital shells).

Electron capture was discovered in 1938 by Luiz Alvarez. Since then, electron capture seems to be a very common mode of decay for neutron-deficient nuclides. It is the only mode of decay when the energy difference between the parent atom and the daughter atom is less than $2m_e c^2$ (two electron masses or 1.022 MeV). If, however the energy is larger, another mode is possible – emission of a positively charged electron – the *positron*.

Positron decay

The existence of the antiparticle to the electron was suggested by Dirac in 1928. Four years later Carl D. Anderson observed a particle with the mass of the electron and with opposite charge in experiments with a cloud chamber and cosmic radiation. He named the particle as *positron* and he was awarded the Nobel prize for this discovery in 1936 – when he was only 31 years old.

As mentioned above, electron capture takes place when the energy between the parent and daughter atom is low (less than $2m_e c^2$). If the energy difference is higher, positron emission may take place. The emitted positron will meet an electron and a “*positronium atom*” will exist for a very short time. This atom disappears in an annihilation process – mainly forming two photons with energy 0.511 MeV flying off in opposite direction. We shall return to this in Chapter 9 in connection with the modern diagnostic technique PET (positron emission tomography).

What is an isotope ?

We have so far, several times, talked about isotopes – assuming that you know the definition. Some isotopes are unstable, and therefore radioactive, while others are stable, and thus non-radioactive. So – what is an isotope?

The nucleus of an atom consists of protons and neutrons (called nucleons). The number of protons determines the element and its chemical properties. The number of nucleons determines the atomic weight.

“Isotopes are atoms with the same number of protons, but with different numbers of neutrons.”

Isotopes are chemically equivalent, but have different atomic weights. All elements have several isotopes – some of them may even be unstable and thus radioactive.

An attempt to illustrate this is shown below for the most common of the elements, hydrogen which has three isotopes. They all have a nucleus with one proton. However, the number of neutrons are; zero, one and two.

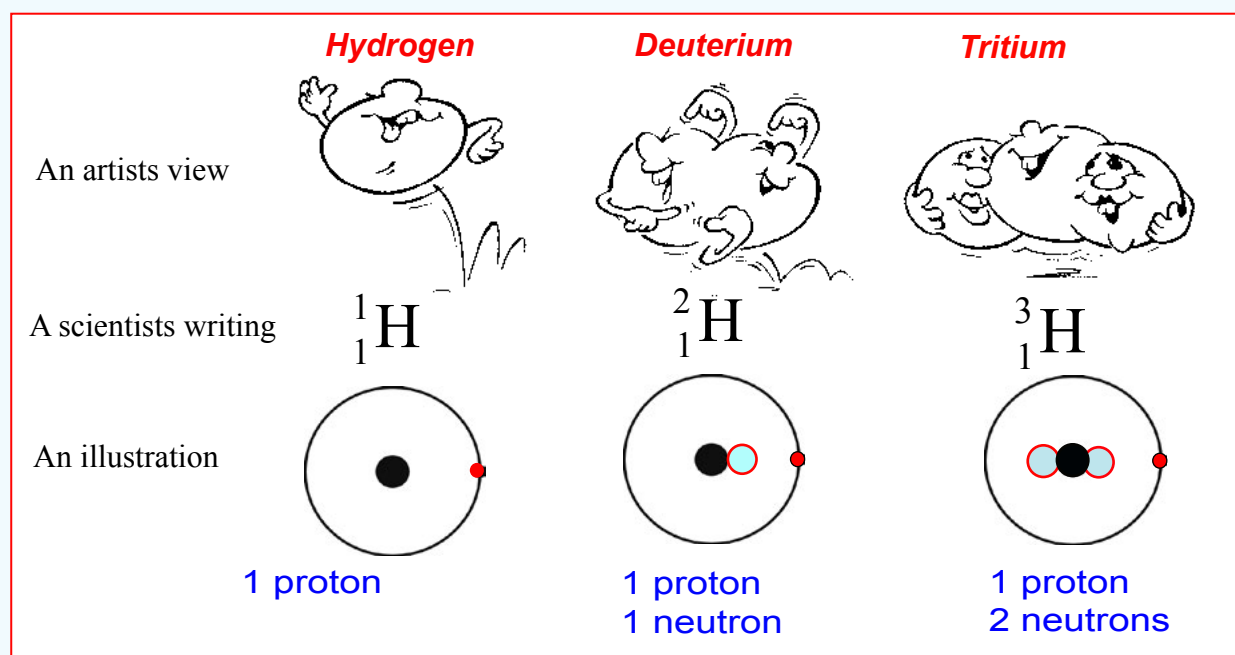

Isotopes are written using the symbol for the element, such as H for hydrogen, O for oxygen, and U for uranium. Furthermore, the nucleon number (the sum of protons and neutrons) is used to separate the isotopes. For example the three hydrogen isotopes mentioned in this book are written; H-1, H-2 and H-3. You will often see the isotopes written as ${}^1\text{H}$, ${}^2\text{H}$ and ${}^3\text{H}$ – similarly for other isotopes.

Since the hydrogen isotopes are so well known, they have attained their own names. H-2 is called deuterium and H-3 is called tritium. The latter isotope is unstable – radioactive. When tritium disintegrates, it emits a β -particle with a maximum energy of 18.6 keV and an average energy of only 5.68 keV. The half-life is 12.3 years (see page 17).

In nature, 99.985 % of hydrogen is the H-1 isotope and 0.015 % is H-2. In ordinary water, only one out of 6500 atoms is deuterium. Ordinary water is H_2O , whereas heavy water is D_2O .

Heavy water – the Vemork sabotage during World war II

The molecular weight for H_2O is 18 (16 for oxygen and $1 + 1$ for the hydrogens). The molecular weight for D_2O is 20 since the mass for D is 2. Consequently heavy water – or pure D_2O , is weighing more than ordinary water (ratio 20/18 or 10/9).

In a fission reaction fast neutrons are emitted, which in turn can induce fission in other uranium atoms. In order to have a chain reaction going, the neutrons must be slowed down (see more about this in Chapter 14). Heavy water and graphite are suited for this purpose – and therefore heavy water was very important in World war II. Heavy water was made by electrolysis, and before the war the power station in Rjukan, Norway was the only commercial plant. Part of the story is the following. In 1906 Norsk Hydro started the construction of Vemork power plant. The famous Rjukan waterfalls was closed and the water was instead directed in “pipelines” directly to the power station which was situated on a shelf above the valley (see picture). Heavy water was a by-product in the fertilizer production. It became an important issue to stop the heavy water production and to hinder the Germans to get any heavy water. Several actions were initiated and carried out to attain this purpose. The most famous sabotage took place in February 1943 when a small group of Norwegians, with the code name “Gunner-side”, crossed the ravine (see picture below) and climbed the steep hill – reached a railway track that led them in to the plant. They destroyed the plant with a loss of 500 liter D_2O .

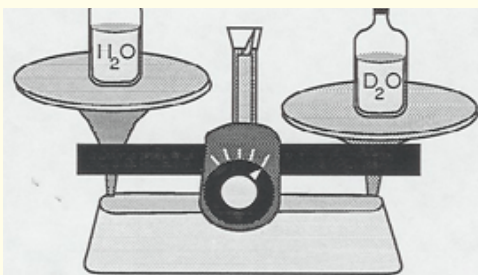

Above is a picture of the Rjukan waterfalls. The waterfall is usually dry, but once every year it runs at a reduced capacity. This picture is from 2007.



To the left is a picture of the power plant Vemork. You see the pipelines down the mountain. Today the power station is turned into a museum.

Natural isotopes

We have 35 nuclides that have half-lives long enough to have survived from the formation of the Earth. They are the so-called *primordial isotopes*. Of these we mention Th-232, U-238 and K-40.

Potassium isotopes – K-40

Potassium is an example of an element that has radioactive isotopes. Potassium consists of 93.10 percent K-39, 6.88 percent K-41 and 0.0118 percent of the radioactive isotope K-40. The latter isotope is primordial with the very long half-life of 1.27 billion years.

The Earth's crust contains a lot of potassium – and in spite of the small fraction of K-40, the radiation from this isotope is quite important. All living organisms contain some radioactive potassium. For example a human being contains, on average, about 60 Bq/kg body weight of K-40. We eat about 2.5 gram of potassium per day – implying that we each day eat about 70 becquerel of K-40.

Furthermore, we have a number of naturally occurring isotopes with shorter half-lives – which implies that they must be formed constantly. Two of the most famous natural isotopes are H-3 and C-14.

Tritium H-3. The tritium isotope H-3 is formed via nuclear processes in the atmosphere. When nitrogen is hit by neutrons both H-3 and C-14 can be formed (see the nuclear reactions below). These processes are going on continuously in the atmosphere and small amounts are always present. Both isotopes are radioactive (half-lives of 12.3 years and 5730 years) – and both are β -emitters.

The concentration of nitrogen in the atmosphere is constant – and if the flux of neutrons from the cosmic radiation is constant, it would be a steady state level of these isotopes.

During the years with nuclear bomb testing in the atmosphere the level of neutrons increased with the result that more tritium and C-14 was formed.

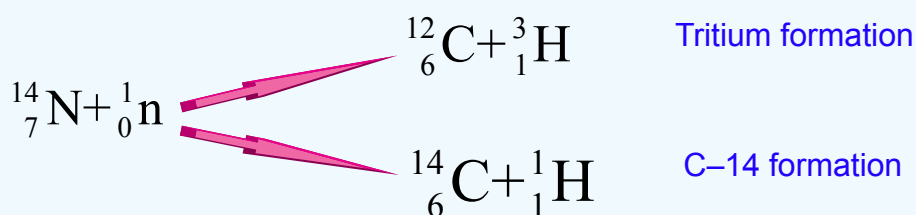

The Radioactive Series (families)

We stated above that a radioactive atom sooner or later will emit radiation in order to attain a more stable state. In some cases it turns out that the daughter nucleus is also unstable – and consequently will emit another particle. Thus, we have a whole series of radioactive atoms. Uranium is a typical example. The start point is the U-238 isotope – which decays through 14 steps and ends up as the stable lead isotope Pb-206. The whole series is shown in the figure below.

Type of radiation	Isotope	Half-life
α	Uranium-238	4.47 billion years
β	Thorium-234	24.1 days
β	Protactinium-234	1.17 minutes
α	Uranium-234	245,000 years
α	Thorium-230	77,000 years
α	Radium-226	1600 years
α	Radon-222	3.82 days
α	Polonium-218	3.05 minutes
β	Lead-214	26.8 minutes
β	Bismuth-214	19.8 minutes
α	Polonium-214	0.164 milliseconds
β	Lead-210	22.3 years
β	Bismuth-210	5.01 days
α	Polonium-210	138.4 days
	Lead-206	Stable

This part of the series is known as; "Radon and radon daughters"

Uranium-radium-series. The start of the series is U-238 and the end point is Pb-206. The first isotope has the longest half-life, 4.47 billion years. Radon and the radon decay products (the 5 isotopes marked red and placed between the two red horizontal lines), have rather short half-lives. Radon is a noble gas and may leak into houses. Its decay products may deposit on particles (dust) in the air and some may end up in our lungs – giving us a radiation dose. It should be mentioned that several of these isotopes emit γ -radiation. It is the γ -radiation that is responsible for the use of radium in radiation therapy. It can also be mentioned that it is the γ -radiation from Bi-214 that is used to observe Uranium.

A series of unstable atoms where one atom changes into another is called a *radioactive family* or simply a *radioactive series*. Altogether, 4 naturally occurring radioactive families have been on Earth. Two of them have almost disappeared (due to the short half-life of the longest lived element) and only the uranium-radium series and thorium-series are still active.

Half-life

A radioactive source consists of a large number of unstable atoms. For example, one gram of the iodine isotope I-131 consists of $4.6 \cdot 10^{21}$ atoms. All these atoms will sooner or later emit radiation, but these emissions do not take place simultaneously. It is a statistical process, with one atom decaying every now and then. When one half of the atoms have decayed the source has gone through what is called one “*half-life*”. After an additional half-life 1/4 of the atoms remain (a half of the half).

The Energy of the Radiation

In order to detect radioactivity and to evaluate the biological effect of the radiation it is important to have information about the energy as well as the type of radiation emitted. The unit used for energy is the *electron volt* (abbreviated eV).

By definition; *one electron volt is the energy attained by an electron when it is accelerated through a voltage gap of 1 volt.*

The product of voltage and the electron charge (given in Coulombs, C) gives the relation between electron Volt and a unit of energy, the joule:



James Prescott Joule
(1818 – 1889)

$$1 \text{ eV} = 1 \text{ V} \cdot 1.6 \cdot 10^{-19} \text{ C} = 1.6 \cdot 10^{-19} \text{ joule}$$

The electron volt is a very small unit. However, it is a convenient unit within this field when discussing x-rays and radioactivity.

The x-ray energy is determined by the voltage between the electrodes. The maximum energy emitted is simply the voltage multiplied with the electron charge – in the range from about 20 000 eV (20 keV) to 300 keV.

The energy released by a disintegration varies from a few thousand electron volts (keV) to approximately 11 million electron volts (MeV). The largest energy is usually taken by the α -particles. The β -particles carry an initial energy up to about 1 million eV (1 MeV), whereas γ -rays exhibit energies up to about 2 MeV.

How is a radioactive source described?

The intensity of the source depends on the number of atoms that disintegrate per second (i.e. the number of becquerels). This is also called the activity.

Other parameters are: *type of radiation, half-life, and energy of the radiation.*

All these parameters can be given by a **decay scheme**.

Decay scheme

A decay scheme is a way physicists use to convey information. The scheme tells us about the types of radiation emitted, the energy involved, half-life, etc. This type of information is valuable in order to find the way of detection – and it is necessary information with regard to calculations of radiation doses and risks.

We shall give a few examples – each isotope has its own decay scheme.

Decay scheme of Cs-137.

Cs-137 is an important radioactive isotope. Cesium has 19 isotopes – only Cs-133 is natural and stable. The isotope Cs-137 is formed as a waste product in a nuclear fission reactor. This isotope is consequently of environmental interest. We can mention that it is also used as a radiation source in cancer therapy. The decay scheme is given in the figure below.

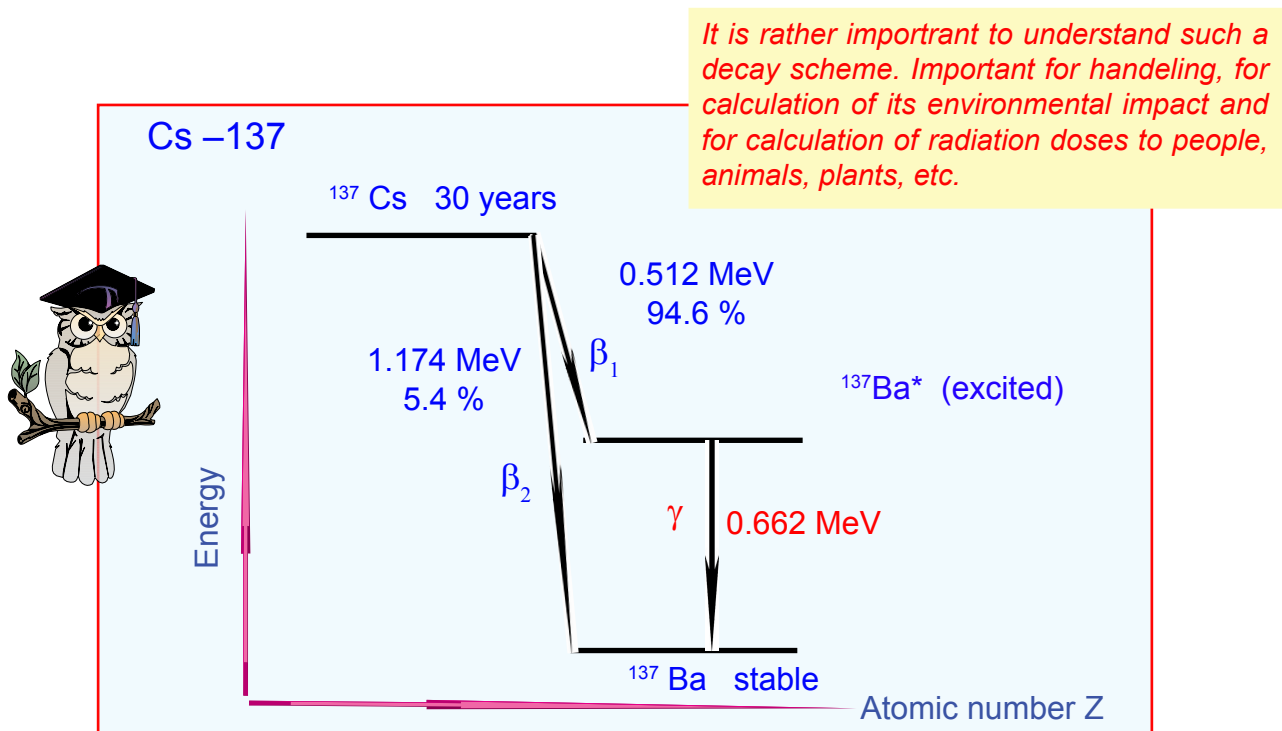

The idea with this particular type of decay scheme is that both the horizontal and the vertical scale involve information. Thus, the atomic number is given along the horizontal line – increasing from left-to-right. Cs has the atomic number 55 and Ba is 56.

The vertical scale indicates the energies involved. Thus, the distance between the lines indicate the energy difference. The energy released by a disintegration is the maximum energy for the β -particle (it must be remembered that this particle is accompanied by a neutrino). In the case of γ -rays – they all have the value given in the scheme. In this case it is 0.662 MeV. The γ -rays is emitted from the excited daughter nucleus.

The decay scheme shows that Cs-137 is transformed into the stable barium isotope; Ba-137. This can take place via two different routes:

1. In 94.6 % of the disintegrations a β -particle is emitted with a maximum energy of 0.512 MeV followed immediately by a γ -ray with an energy of 0.662 MeV.
2. In 5.4 % of the disintegrations the stable barium isotope is reached directly by emitting only a β -particle, with a maximum energy of 1.174 MeV.

The decay scheme also shows that the half-life of Cs-137 is 30 years. In addition, one might guess that Cs-137 can be observed by measuring the emitted γ -rays. Gamma-rays are very *penetrating*, they have the same energy (0.662 MeV) and are easily detected and identified using a so called gamma-counter.

The decay scheme also include β -particle emission and the maximum energy is given. We know that the average β -energy is about 1/3 of the maximum energy.

Decay-scheme for Co-60

Cobalt has atomic number 27. Only the Co-59 isotope is stable, but we have more than 20 unstable isotopes of cobalt. Co-60 is made from Co-59 in a reactor by exposure to neutrons. Co-60 is used in radiation therapy, for sterilization of medical supplies, for radiation treatment of foods and for industrial radiography. The decay scheme is given below.

The half-life is 5.27 years. It decays by mainly (99.88 %) by emitting a β -particle – followed by the emission of two γ -ray photons with energy of 1.17 MeV and 1.33 MeV respectively.

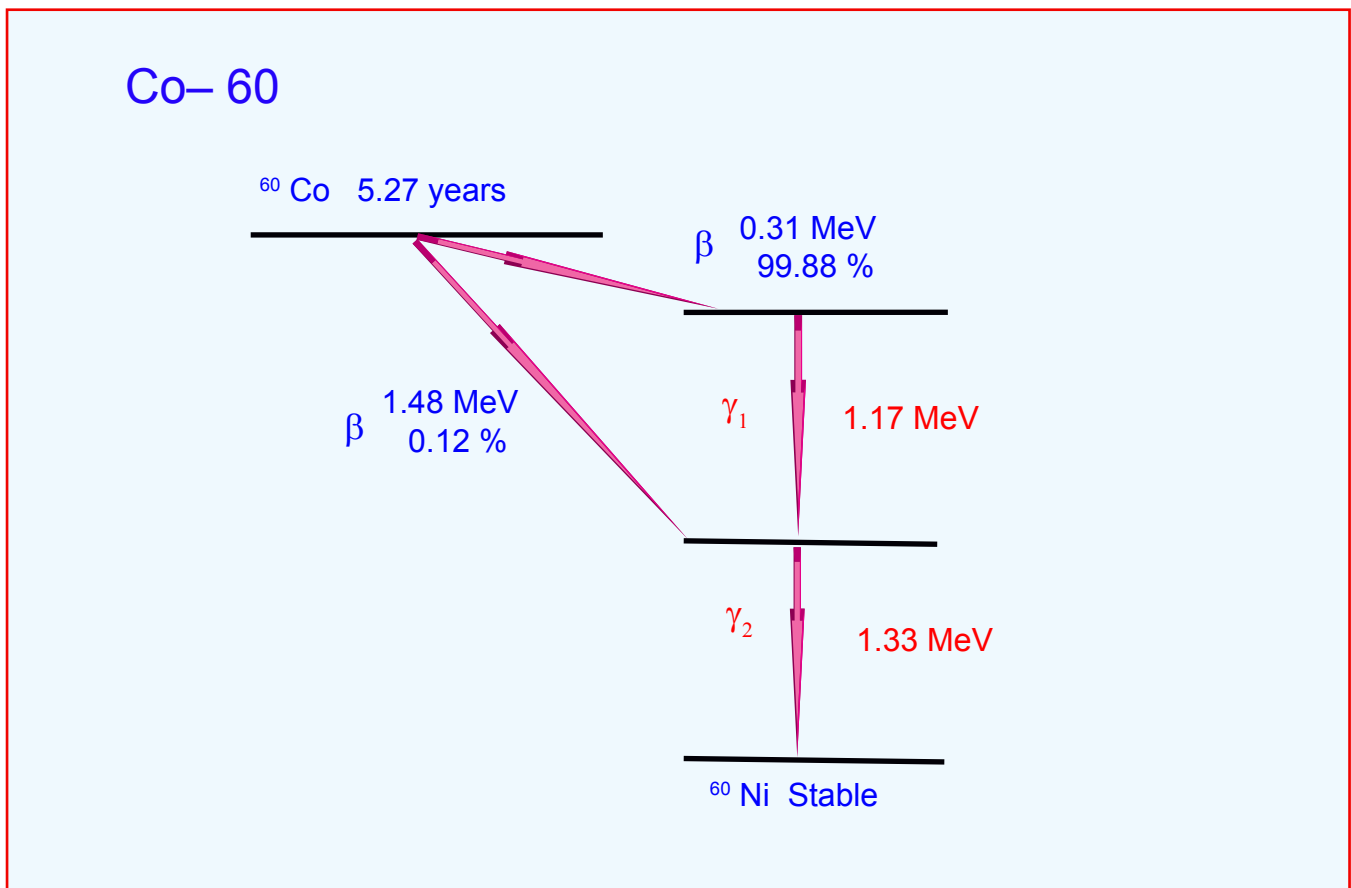

Decay schemes for tritium H-3 and carbon C-14

We mentioned above that these two isotopes (H-3 and C-14) are formed in the atmosphere after neutron bombardment of nitrogen. They are both pure β -emitters with decay schemes shown below. Both isotopes are used in research; H-3 as a tracer in many biological experiments (for example thymine in DNA can be labelled), and C-14 is used for dating purposes.

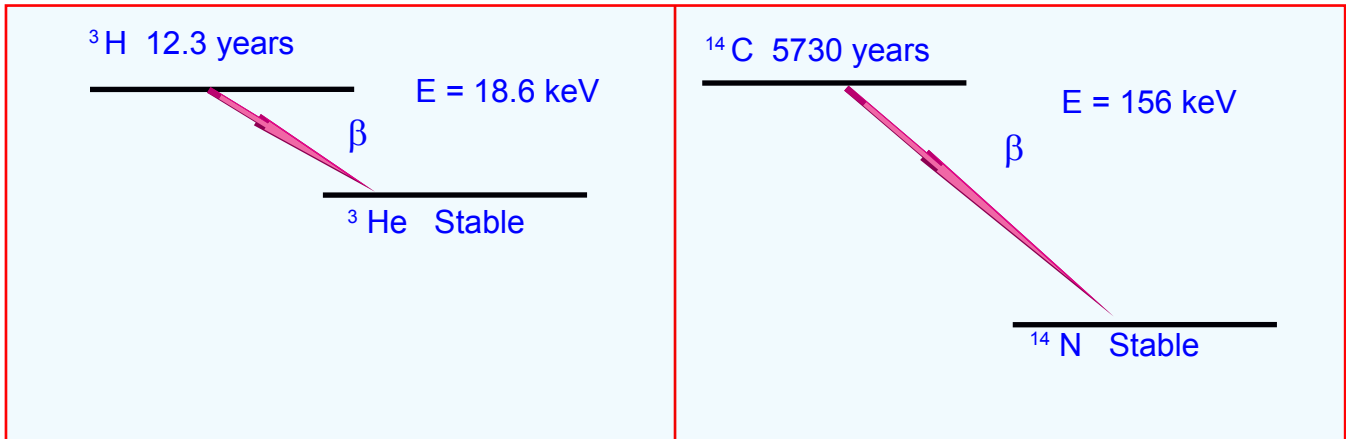

As you can see the two isotopes have no γ -emission. Furthermore, the β -particle energy is low – for tritium very low since the maximum is 18.6 keV. Since these β -particles have a very short range, even in air, a number of problems occur with regard to measurements. In recent years several methods have been developed – in which the detector material is mixed into the sample. In an earlier period auto radiography (the sample was covered with a film) was used.

Due to the very low β -particle energy, these isotopes represent no hazard to humans when they are outside the body – and they yield a very small dose when they are inside the body.

Decay scheme of K-40

The last example would be the decay scheme of the potassium isotope K-40 – mainly because it is different from the other examples. In this case we have to include a decay route via “*electron capture*”.

K-40 is a natural isotope since 0.0118 % of all potassium is K-40. It has a half-life of 1.27 billion years and have been with us all the time. Potassium makes up about 1.5% of the weight of the Earth’s crust and is the seventh most abundant element. This implies that you will find radioactive potassium everywhere – also in our bodies. We have earlier mentioned that we all have a level of K-40 of about 60 Bq/kg in our bodies. The content is higher for men compared to women – and seems to vary with the muscle mass – reaching the highest values when you are about 20 years.

The decay scheme is given in the figure on the next page.

K – 40

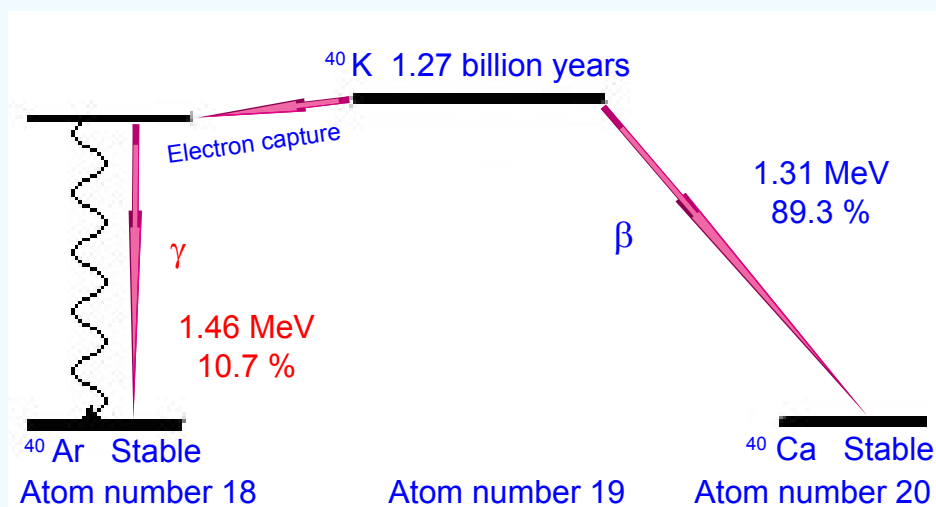

The decay of this isotope is somewhat special. Thus, in 89.3 % the decay is by the usual β -decay, with emission of an electron with a maximum energy of 1.31 MeV. For 10.7 % of the disintegrations the decay route is different. Here we have an electron capture and potassium is transferred to argon. This nucleus is in an excited state and emit γ -rays with an energy of 1.46 MeV. This mode of disintegration includes also some characteristic x-rays – because one of the orbital electrons is captured by the nucleus and leaves a hole that is filled with other electrons.

Summary – decay schemes

We have about 3400 radioactive isotopes. About 900 have half lives of more than 60 minutes. Furthermore, 339 are naturally occurring isotopes.

It can be mentioned that all elements above lead ($Z = 82$) are radioactive. In order to use and handle all the isotopes we must know quite a lot about how they are formed – the half-life, the particle emitted, the energy – in other words the **decay scheme**.

Some of the decay schemes are very complicated, like those including the radioactive series. We have for many years used radium for cancer treatment. In this case we are only interested in the γ -radiation from all the isotopes involved.

Throughout this book we are interested in radioactive isotopes connected to medicine, tracer technology as well as to the environment. Let us mention a few.

The radioactive series (Uran-radium series and Thorium-series) are important, both with regard to energy production, cancer-therapy and lung cancer formation from radon and daughters.

We are interested in the isotopes used within life sciences for tracer technology, as well as those used for medical purposes within diagnostic such as PET.

In Chapter 9 we are discussing PET and the use of Tc(m)

Some of the radioisotopes are present, some are made as surplus, and others are made artificially determined to distinct projects. All the time we must have knowledge about the decay scheme – in order to treat the isotopes in a safe way. We must know the half-life, the particle(s) emitted and their energy – this include also the daughter elements if they are not stable.

Artificial isotopes are made in reactors by (n, γ) reactions, some are made in cyclotrons and particle accelerators. Consequently, a lot of experimental equipment are involved both for production as well as for the detection of the radiation.

You can see more of the use of radioactive compounds in the address:

<http://www.frankswebpace.org.uk/ScienceAndMaths/physics/physicsGCSE/usesNuclear-Radiation.htm>

How radiation is absorbed in matter

When x-rays and radiation from radioactive sources hit matter it will collide with the constituent atoms and molecules with the result that ions and excited molecules are formed. The radiation itself will gradually loose energy and finally be stopped. The penetration depth vary considerably with the type of radiation and the type of material that is hit. Since we, in this book, is mainly engaged in living organisms, we will relate penetration depths to tissue – or simply water which is the major constituent of tissue.

The type of collision processes vary with the type of radiation. Thus, charged particles like α -particles and β -particles interact with electrons in the absorbing matter in so called Coulomb collisions – whereas x - and γ -rays take part in other types of reactions. The final result of all these reactions is, however the same. Ions and excited molecules are formed. Consequently, the radiation is known as “*ionizing radiation*”. The result can be illustrated as follows:



M is the molecule hit by radiation. The result may be either an ionization or an excitation. M^+ is a positively charged molecule (positive ion) and e^- is an electron that was knocked out of the molecule in the process. The expelled electron will loose energy in reaction with other molecules (it may even ionize some new molecules), and will finally end up on some molecule forming a negative ion. M^* is an excited atom or molecule. In this process not enough energy is available for ionization (see figure next page).

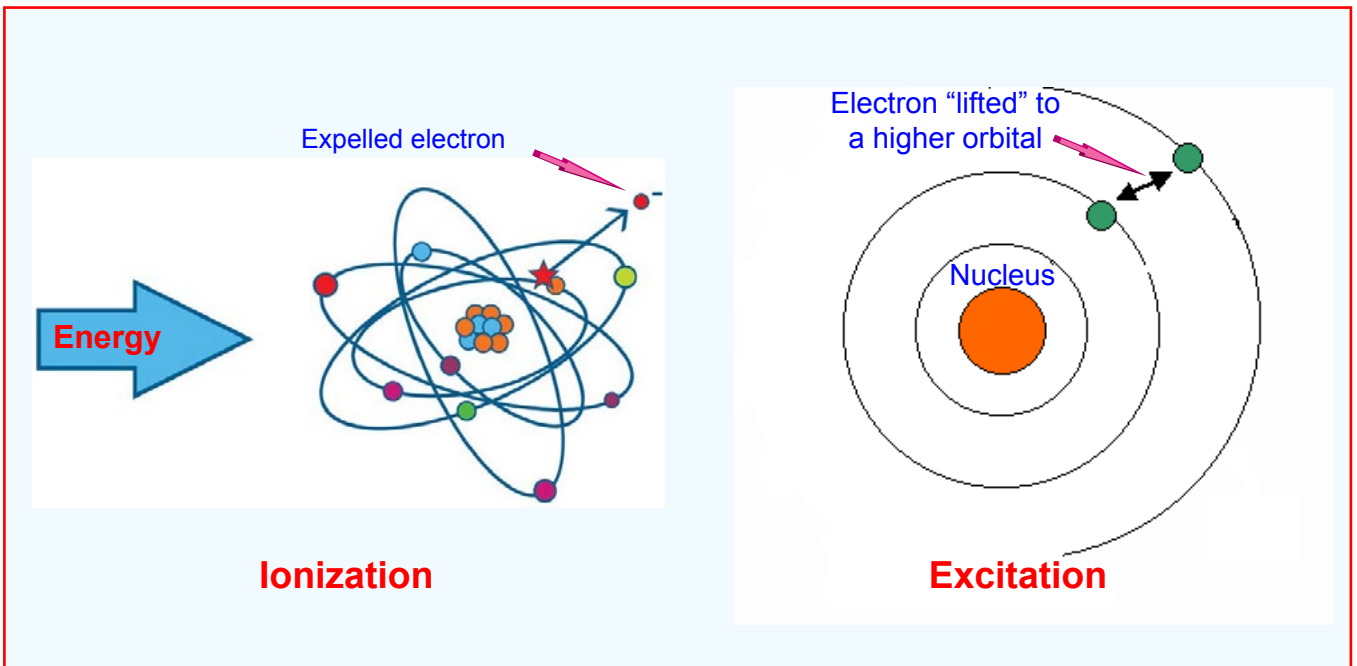

Absorption mechanisms for the different types of radiation

Alpha-radiation

The energy of an α -particle, when it is emitted by a nucleus, is usually a few MeV (this is very large compared to the energy attained by β -particles and γ -radiation). Some of the properties which are characteristic for the absorption of α -particles are:

1. The alpha-particles loses energy by Coulomb collisions. The particle-path, the track, is rather straight and the lost energy makes a core of ions, with δ -rays extending out of this core – like the branches of a tree. The larger the δ -ray energy the longer is the δ -tracks.
2. The number of ions formed in the core track is large and can be described by the so called Bethe formula (named after Hans Bethe, who introduced it in 1930). A “light version” of this formula is:

$$\frac{dE}{dx} \approx k \frac{z^2}{v^2}$$

Hans Bethe
(1906 – 2005)



z is the charge of the moving particle, and v is the velocity.

The energy deposited per unit length of the track (dE/dx) is called the “**Linear Energy Transfer**” (abbreviated **LET**). Examples of LET-curves from heavy ions hitting a biological target are given on the next page.

The **range** of an α -particle from a radioactive source is very short in tissue (water) and in air the range is only a few centimeters. Thus, a 10 MeV α -particle has a range in air of 10 cm and in tissue or water about 0.12 mm. The range for almost all α -particles from radioactive sources is shorter since the start energy of the α -particle is below 10 MeV. That implies that the range is only a few cell-diameters.

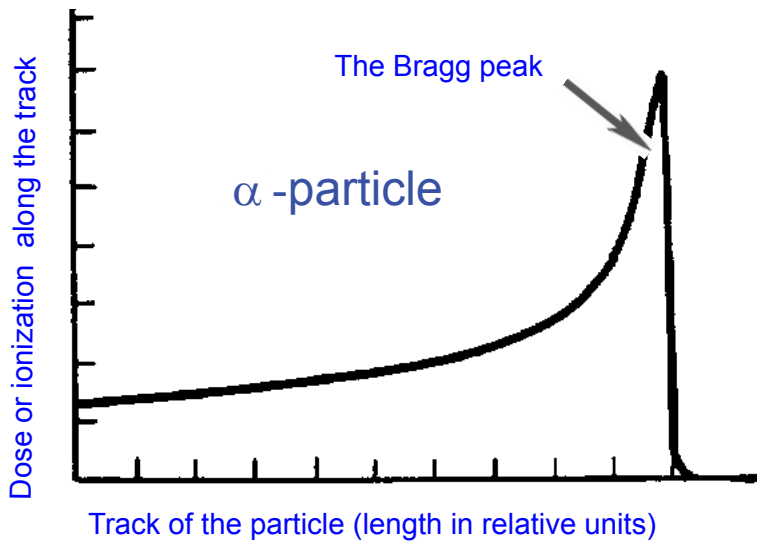

The Bethe formula describes the energy deposition along the track of the ionized particle. Since the velocity decreases towards the end of the track, the curve has a particular shape as shown in the figures to the left.

The peak in the absorption curve in the end is called the **Bragg peak**.

In the figure to the left is given the Bragg-curve for an α -particle. The range is determined by the start energy.

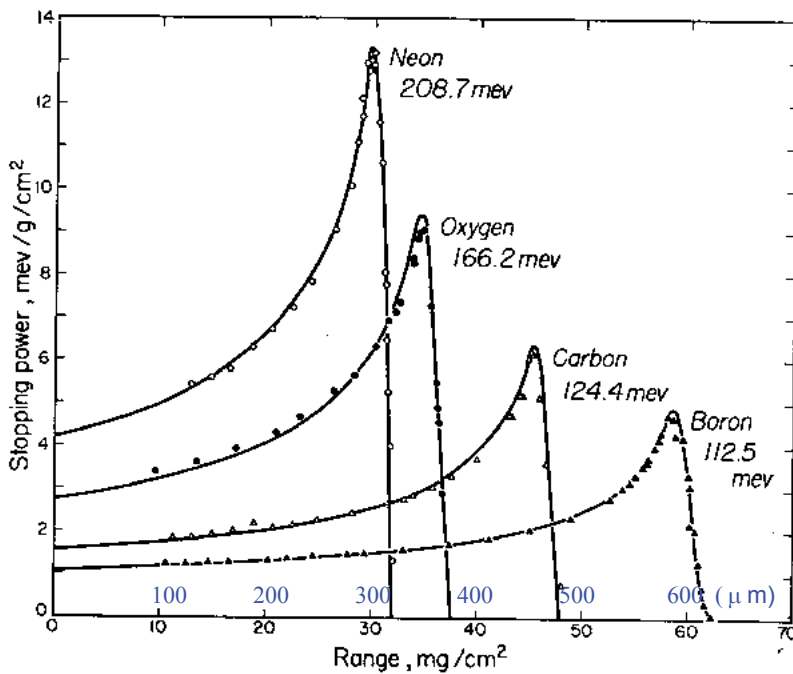

In the figure below we have given some Bragg curves for accelerated heavy ions. The start energy of the ions are given in the figure.

The ions were accelerated with the HILAC (Heavy Ion Linear Accelerator) in Berkeley around 1960. The max energy achieved was 10.4 MeV per nucleon. Thus C^{+6} -12 ions had an energy of about 124 MeV. The range in tissue is given in μm (above the abscissa). With this short range it was possible to irradiate enzymes, bacteria, virus and yeast cells.

Data above are from Tor Brustad in "Advances in Biological and Medical Physics. Volume VIII" 1962)

We would like to mention that with present days large accelerators it is possible to use heavy particle beams in cancer therapy. Thus, if we could land the "Bragg peak" on the tumor, the tumor dose would be much larger than the dose to the surrounding healthy tissue. This is the main goal of radiation therapy. In some of the hospitals around the world have already (2013) established this possibility.

We shall return to this issue in combination with heavy ion therapy in Chapter 10.

Beta particles

β -particles are stopped by collisions with electrons in materials in a process similar to the way α -particles are stopped. As a rule of thumb one can say that a β -particle with an energy of 1 MeV will have a range in water or soft tissue of 0.5 cm. The β -particles from Cs-137 have an average energy of 0.2 MeV. If these particles hit the skin, the penetration into the body would be less than 1 mm. However, if a sufficient number of these β -particles hit the skin, it will be burned.

Gamma-radiation

The energy of a γ -ray is given by the expression:

$$E = h\nu$$

where h is a fundamental constant, known as Planck's constant and ν is the frequency of the radiation. The radiation can be considered to consist of small energy packages called quanta or photons. The energy of the γ -photon, ranges from 0.1 to about 2 – 3 MeV.

We have seen that the γ -rays, following a disintegration from Cs-137 have an energy of 0.662 MeV, from the cobalt isotope Co-60 two quanta with energies of 1.17 and 1.33 MeV are emitted and from K-40 the γ -rays have the energy of 1.46 MeV.

Gamma-rays and x-rays are absorbed differently from α -particles. When γ -rays penetrate a material, the intensity of the radiation (I) decreases according to an exponential formula:

$$I(x) = I_0 \cdot e^{-\mu x}$$

where x is the depth in the material and μ is the absorption coefficient (μ describes how the radiation decreases per unit length for each type of material).

The absorption coefficient has **three** different components. This is because three processes are involved: **photoelectric effect**, **Compton scattering** (inelastic scattering) and **pair production**.

X- and γ -rays is absorbed by 3 processes:

1. Photoelectric effect (important for energies up to 100 keV).
2. Compton scattering (important in the energy range 0.1 – 20 MeV).
3. Pair production (takes place only for energies above 1.02 MeV).

All 3 processes varies with the electron density (that is the atomic number) of the absorbing material. This implies that x-ray pictures yield the electron density of an object.



Photoelectric effect

This is a process in which a photon interacts with a bound electron. The photon itself disappears, transferring all its energy to the electron and thereby imparting kinetic energy to the electron – which in turn can ionize other molecules.

This is the most important absorption process for radiation with an energy less than about 100 keV (which is the type of radiation used in medical diagnostics). The photoelectric effect varies dramatically with the electron density of the absorbing medium. Thus material that contains atoms with high atomic numbers, e.g., the calcium in bone, gives strong absorption due to the photoelectric effect. Furthermore, we make use of this effect when contrast media are introduced.

Compton scattering

This is a process in which a photon collides with a bound electron and where the photon energy is considerably greater than the electron binding energy. An attempt to visualize this is given by the artists drawing and the figure below.

After the interaction, the photon continues in a new direction with reduced energy and the electron attains enough energy to leave the atom. We call this electron a *secondary electron*. The Compton process is the most important absorption process for photons with energies from about 100 keV to approximately 20 MeV (the type of radiation mainly used for radiation therapy).

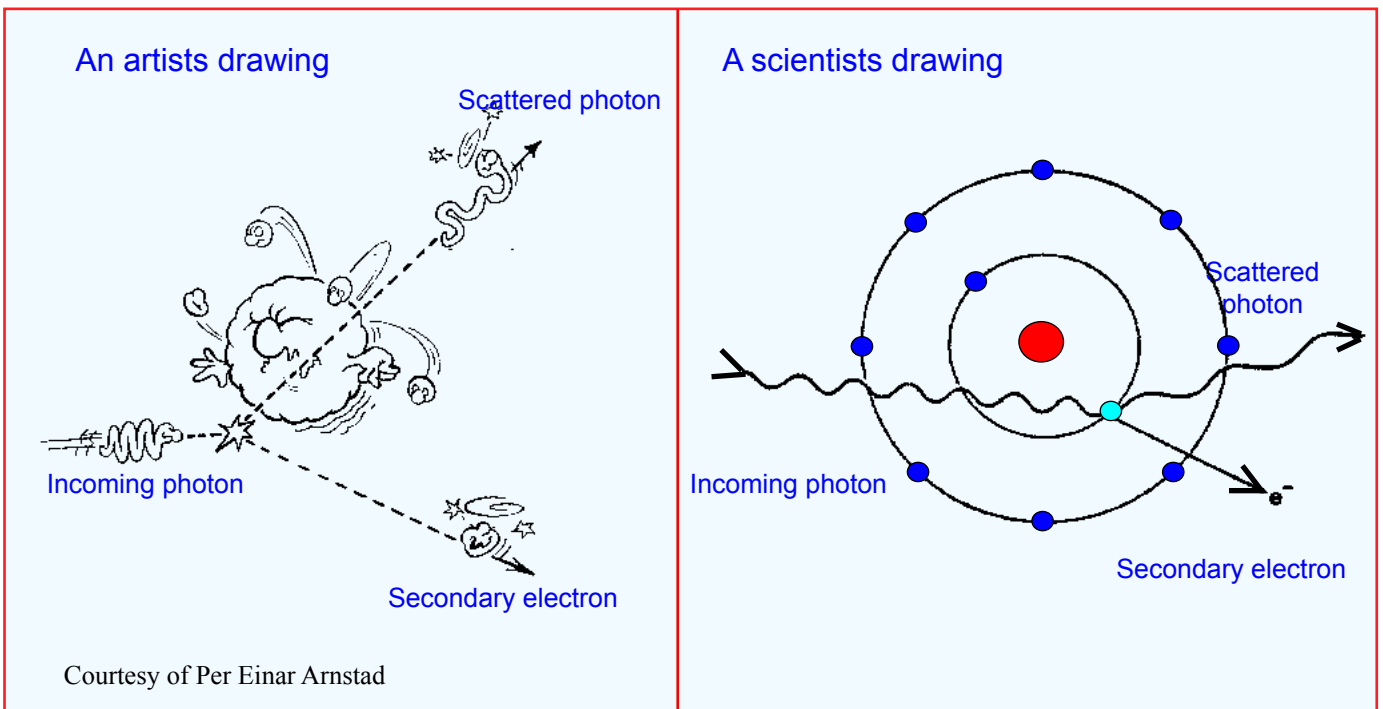
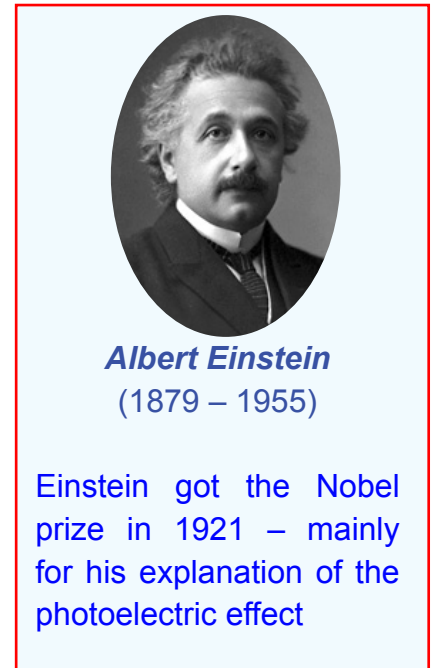

This is an illustration with the purpose to describe the Compton process. It all starts with the incoming high energy photon interacting with an electron. The result is that the photon is scattered and its energy is reduced. The electron involved in the interaction is ejected and becomes a "secondary electron" – which in turn can ionize along its own track.



© The Nobel Foundation

Arthur H. Compton
(1892 – 1962)

Arthur Compton was born in Ohio. He began to study X-ray scattering and in 1922, he found that X-ray wavelengths increase due to scattering by "free electrons". The scattered quanta have less energy than the quanta of the original ray. This discovery is known as the "Compton effect" – and gave him the Nobel prize in Physics for 1927.

During the war, Compton, along with Vannevar Bush and Ernest Lawrence started the Manhattan Project with the purpose to make an atomic bomb. At the university of Chicago, Compton had a facility with the cover name "Met Lab". Its objectives were to produce chain-reacting "piles" of uranium to convert uranium to plutonium. Furthermore to find ways to separate the plutonium from the uranium and to design a bomb.

In December 1942, underneath Chicago's Stagg Field, a team of Met Lab scientists, directed by Enrico Fermi, achieved a sustained chain reaction in the world's first nuclear reactor.

The Nobel Prize in Physics 1927

To Arthur Holly Compton
"for his discovery of the effect named after him"

Pair production

Pair production is a process in which the energy of the photon is used to produce a positron-electron pair. The photon energy must be above 1.02 MeV, the threshold energy for forming two electrons. The process takes place near the atomic nucleus and is the most significant absorption mechanism when the photon energy is above about 20 MeV.

Pair production is found in many experiments where high energy radiation interacts with matter. It was first observed by the British scientist Patrick Blackett in 1933 in some cloud chamber experiments with cosmic radiation. He found tracks like that in the illustration – where the electron and positron is deflected in opposite directions in an electric or magnetic field. Blackett was awarded the Nobel prize in Physics for his discoveries in 1948.

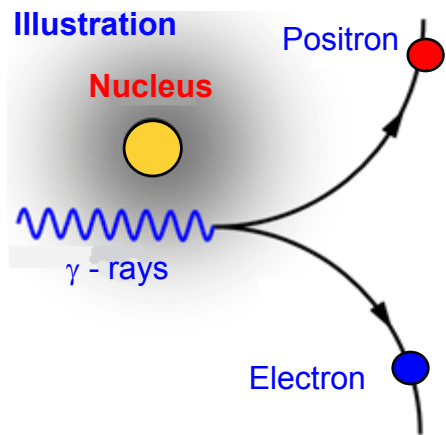

Patrick M.S. Blackett
(1897 – 1974)

The Penetration of Radiation

We have described the different absorption processes for the radiation from radioactive sources and x-ray machines. We can therefore get a picture of the penetration of the radiation in materials.

If we are using a gun, the penetration by the bullet depends on the energy of the bullet as well as the composition of the target. For example, a pellet from an air gun will be stopped by a few millimeters of wood, whereas a bullet from a high powered rifle will pass through many millimeters of steel. It is similar with ionizing radiation. There are large differences in penetrating ability depending on the type of radiation (α -, β - or γ -radiation). The illustration below gives you an idea about the penetration of the radiation from the radioactive sources.

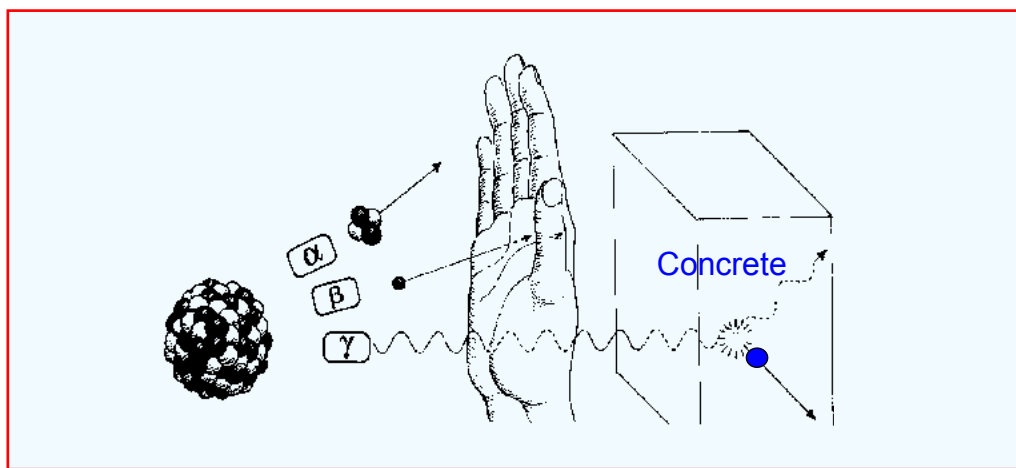

Alpha particles from radioactive sources have a range of less than 10 cm in air. In condensed matter such as water or tissue the range is much shorter (the difference in range is approximately 1/1000, due to the difference in density) – usually less than 100 μm . This implies that α -particles will not even penetrate clothing. If α -particles only are emitted “*you can sit on the radioactive source*”. If, however, the source is inside the body, all the energy is deposited in the body and may give a large radiation dose.

A tragic example of this was the poisoning of Aleksandr Litvinenko in 2006 with Po-210. This isotope emits an α -particle with energy 5.3 MeV

Beta-particles with an energy of 1 MeV have a range in soft tissue of approximately 5 mm. The majority of β -particles have an energy far less than 1 MeV.

Consequently, almost all β -particles coming from sources in the environment are stopped by clothing.

Gamma-radiation has the ability to penetrate tissue and even concrete (see illustration above). For example, 50 % of the γ -rays from Cs-137, with energies of 0.662 MeV will penetrate a water layer of about 9 cm. We call this a **half-value layer**. Five half-value layers (less than 0.5 meter of water) will reduce the radiation by 97 percent. γ -radiation is easy to measure, whether the source is outside or inside the body. Consequently, isotopes emitting γ -radiation are used in medical diagnostic.

Summing up

X-rays and γ -rays will easily penetrate the human body. This property is utilized when x- and γ -rays are used for diagnostic purposes. α - and β -particles, on the other hand, lose their energy within a short distance and cannot penetrate the body. Because of these penetration properties, γ -radiation is easy to observe whereas α - and β -radiation are more difficult to detect. Special instruments are often needed in order to observe α - and β -rays. The following conclusions can be drawn:

- If a radioactive source is on the ground, such as in a rock, the α - and β -radiation will be stopped by air and clothes. Only γ -rays would penetrate into the body and deliver a radiation dose.
- When a radioactive source is **inside** the body, it is a different situation. α - and β -particles are completely absorbed within a short distance in the tissue, whereas only a certain fraction of the γ -radiation is absorbed. The rest of the γ -radiation escapes and can be observed with counters outside the body. Consequently, if you eat food containing radioactive compounds, they can be easily measured if γ -rays are emitted.

It is possible then to measure the radioactivity that is inside animals and humans which have eaten food containing Cs-137 due for example to fallout from nuclear tests or nuclear accidents. For adults, approximately 50 % of the γ -radiation escapes the body and the other half is absorbed by the body. Other important isotopes such as Sr-90 (strontium) and Pu-239 (plutonium) are very difficult to observe since they only emit β -particles and α -particles.



The start point for all biological effects of ionizing radiation is the **excited** and **ionized** molecules that are formed. These primary products are very reactive and have short life times in living systems – of the order nanoseconds or less.

Several ingenious methods and techniques have been explored to study the primary radiation products – and we shall explore some of them in this book. It has been found that the biological effect depends both on the distribution as well as the number of ions and excited molecules formed.



Chapter 3

Radioactive Decay Laws

Half-life

The term half-life has been mentioned earlier. So far, this has referred to only the *physical half-life*. When considering health and the environment, we have to introduce also the *biological half-life*. Furthermore with regard to environment and biology we sometimes use the *ecological half-life*.

Definition

The half-life is defined as the time elapsed when the intensity of the radiation is reduced to one half of its original value.

The Physical Half-life

The radiation from a radioactive source will gradually be reduced. The rate of this decay is given by the half-life. It is usually denoted as $t_{1/2}$ – but sometimes as t_p for the physical half-life.

In an experiment in which the intensity of the radiation is measured versus time, a curve like that shown in Figure 3.1 is observed. The activity is given along the vertical axis (100 % when the experiment is started) and the time (in half-lives) is given along the horizontal axis.

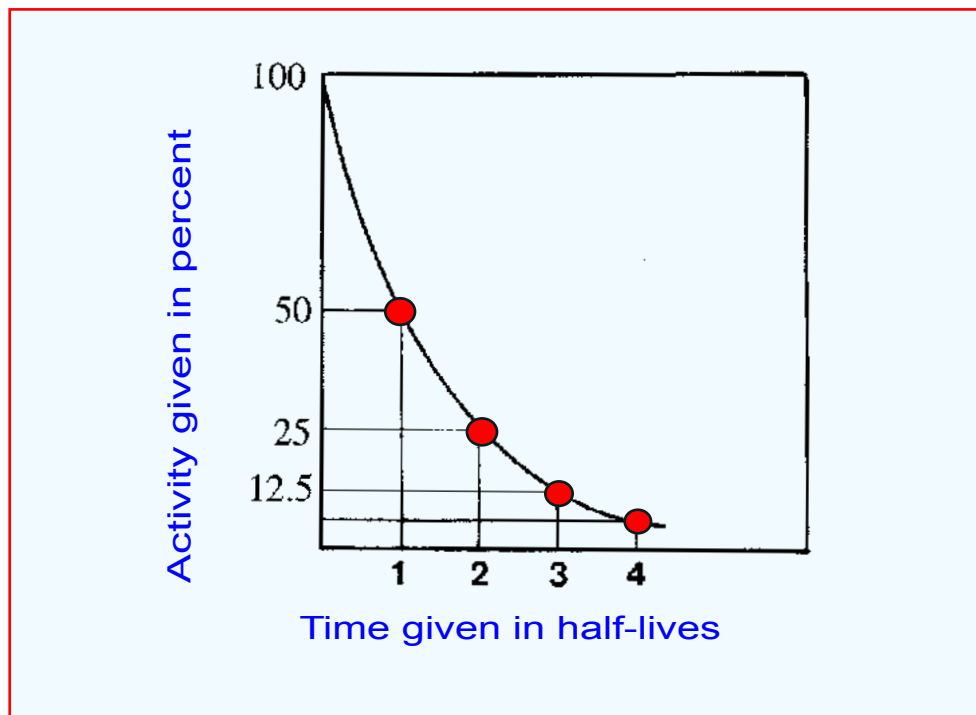

Figure 3.1. The radiation from a radioactive source decreases with time as shown. The curve can be described by an exponential formula. The figure demonstrates the meaning of the half-life.

After one half-life the intensity of the radiation has decreased to 50 %. After two half-lives only 25 % remains, and so on. Each half-life reduces the remaining amount by one half.

The Earth still contains large amounts of naturally occurring radioactive isotopes, such as U-238. For this to occur the half-lives must be very long. We saw in Figure 2.3 that U-238 has a half-life of 4.47 billion years.

The Laws of Radioactive Decay

The activity of a radioactive source (A), i.e. the number of disintegrations per second (becquerel), is given as:

$$A = -\frac{dN}{dt} = \lambda \cdot N$$

λ is the *disintegration constant* and it varies from one isotope to another. N is the number of atoms that, in time, will disintegrate and dN is the change in N during the time interval dt . The negative sign shows that the number remaining is decreasing.

Equation 3.1 shows that when N is larger, the radioactive source is stronger. The difference in activities from one isotope to another is due to the different half-lives which depend on different disintegration constants λ (see equation 3.3).

In order to determine how the the number of atoms (N) decrease with time, the change in N must be summed over time. This is done mathematically by integrating, giving:

$$N = N_0 \cdot e^{-\lambda t} \quad (3.2)$$

N_0 is the number of radioactive atoms at time zero (i.e., when the first measurement was made). By substituting a later time (day, year) for t in (3.2) we can solve the equation and determine the radioactivity at the new time.

The two equations (3.1) and (3.2) are very important in order to evaluate risks and radiation doses. These equations are used in the examples later in the book.

It was noted above that there is a relation between the half-life ($t_{1/2}$) and the disintegration constant λ . The relationship can be found from equation (3.2) by setting $N = \frac{1}{2} N_0$. This gives:

$$t_{1/2} = \frac{\ln 2}{\lambda} \quad (3.3)$$

where $\ln 2$ (the natural log of 2) equals 0.693.

If the disintegration constant (λ) is given, it is easy to arrive at the half-life, and vice-versa. In calculations using radioactive compounds one of these two constants must be known.

Biological Half-life

Radioactive isotopes that are ingested or taken in through other pathways will gradually be removed from the body via kidneys, bowels, respiration and perspiration. This means that a radioactive atom *can* be expelled before it has had the chance to decay. The time elapsed before half of a compound (whether radioactive or not) has been removed by biological means is called the *biological half-life* and is usually denoted t_b .

If a radioactive compound with physical half-life t_p ($t_{1/2}$) is cleared from the body with a biological half-life t_b , the "**effective**" **half-life** (t_e) is given by the expression:

$$\frac{1}{t_{\text{effective}}} = \frac{1}{t_{\text{physical}}} + \frac{1}{t_{\text{biological}}} \quad (3.4)$$

If t_p is large in comparison to t_b , the effective half-life is approximately the same as t_b (see example below).

The biological half-life is rather uncertain as compared to the exact value of the physical half-life. It is uncertain because the clearance from the body depends upon sex, age of the individual and the chemical form of the radioactive substance. The biological half-life will vary from one type of animal to another and from one type of plant to another.

Radio-ecological Half-life

Radio-ecological half-life is even less precise than the physical and biological half-life. Consider a region which has been polluted by a radioactive isotope (for example Cs-137). Part of the activity will gradually sink into the ground and some will leak into the water table. Each year, a fraction of the activity will be taken up by the plants and subsequently ingested by some of the animals in the area.

Radio-ecological half-life is defined as the radioactive half-life for the animals and plants living in the area. It varies for the different types of animals and plants.

Summing up

With regard to radioactive pollution we have the following:

1. The type of a radioactive isotope must be established. Each isotope has a well determined physical half-life.
2. If the isotope enters a living biological system, it will be excreted with a biological half-life which is related to the living system itself. This implies that the ingested radioactivity may decrease more rapidly – and that an effective half-life has to be used when calculating doses and evaluating the health effects.
3. The fallout in an area will be more and more unavailable for uptake in a biological system with time. Knowledge about this is lacking.

Examples on how to use the knowledge

Cs-137 has a physical half-life of 30 years. This isotope was the most prominent of the radioactive isotopes in the fallout following the Chernobyl accident in the Ukraine in 1986 – a number of European countries had a fallout of up to 100 000 Bq per m² in certain areas.

The activity of Cs-137 can easily be measured because of the γ -radiation emitted. Thus, whether Cs-137 is on the ground or in plants, animals and humans it can be measured. Cesium gradually sink into the ground, some will leak into the water table, and some of it will find its way into the food system and into animals and humans.

One such way is for example illustrated in the picture. Cs-137 comes into the grass and then into the sheep. When we eat the meat the Cs-137 will enter our bodies.

Cesium is cleared rather rapidly from the body and the biological half-life for the sheep is 2 – 3 weeks. If we use equation 3.4 we will find that the effective half-life is almost exactly equal to the biological half-life. Now we can imagine two scenarios:

1. The sheep in the polluted area are slaughtered directly. The Cs-137 activity in the meat will then decay with a half-life equal to the physical one – 30 years.

2. The sheep are moved to an area with no activity – or fed on non-radioactive food. The activity in the sheep will then decay with the biological half-life. After approximately 4 weeks the activity has been reduced to about 25 percent in the living sheep.

This may be a way to reduce the radioactivity in the meat. When you slaughter the animal it is the physical half-life that count – whereas in a living system the biological half-life may be very important.

Some other radioactive species like radium and strontium are bone seekers and the biological half-life is rather long. These isotopes are much more difficult to remove – and if radium is ingested, it is retained the rest of one's life.



Can uptake be prevented?

It may be possible to reduce the effects of a radioactive compound by simply preventing its uptake. This is a questionable issue that has been discussed after the Chernobyl accident. The isotope in question is I-131 (Iodine). This isotope is important, mainly during the first weeks after a pollution. In the Chernobyl accident considerable amounts of I-131 was released – which resulted in fallout to regions in Russia, Belarus and Ukraine.

I-131 emits β -particles. The main fraction has a maximum energy of 0.606 MeV. The β -particle emission is followed by γ -rays with energy of 0.365 MeV (and others). The physical half-life is 8.04 days. The isotope is mainly taken up by the thyroid gland – and all β -particles give off their energy to the thyroid. The biological half-life in the thyroid is approximately 120 days. This reduces the effective half-life to 7.6 days.

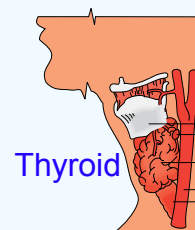

In this case the idea has been considered to add non-radioactive iodine to the food. All iodine isotopes are chemically identical and the body can not discriminate one isotope from the other. There will be a competition between the different isotopes. If the amount of non-radioactive iodine is far larger than the radioactive isotope the uptake of radioactivity may be hindered. This method seems however to be a risky one. Potassium iodide (with non-radioactive I-127) was used in connection to the Chernobyl accident. Whether this reduced the thyroid dose is not known.

It can be mentioned that I-131 is used for treatment of different sicknesses to the thyroid

C-14 used as a biological clock

Radioactive carbon (C-14) has a half-life of 5730 years. In spite of this rather "short" half-life compared to the age of the earth, C-14 is a naturally occurring isotope! The reason for this is that C-14 is formed continuously in the atmosphere when neutrons (originating from the cosmic radiation) interact with nitrogen atoms. This reaction can be written:

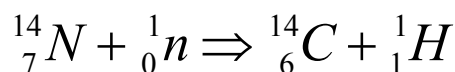

Carbon exists in the atmosphere as a component of carbon dioxide. Most of the carbon dioxide contains the ordinary C-12 isotope. However, a few molecules are made with the C-14 isotope. The C-14

isotope enters the biosphere when plants utilize carbon dioxide in photosynthesis. Consequently, all biological systems; plants, animals and humans contain a certain level of C-14. As long as the biological system is alive the level is constant. When the system die – the level of C-14 decay according to the physical half-life. This implies that with knowledge about the half-life and the C-14 level when living – it would be possible to calculate the time elapsed from the death; that is a "biological clock".

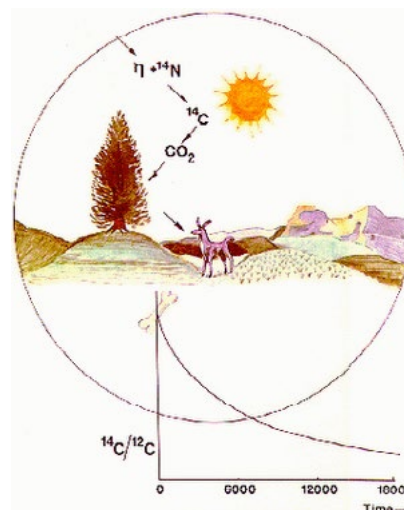

It was Willard Libby and coworkers in USA that explored the possibility to use C-14 for dating. During the 1940-ties and 1950-ties they worked on this method. Libby assumed that the cosmic radiation was constant with the result that the formation of C-14 would be constant (we shall return to this point). This implies that all living organisms would have a constant specific level of C-14. They made a lot of experiments and found that the C-14 level was on average 15.3 disintegrations per minute per gram carbon (this is 0.255 Bq per gram carbon or 255 Bq/kg).

They determined the physical half-life and found in 1948 the value 5568 years. This is shorter than the value we use today – and it is known as the "Libby half-life". With these two parameters in hand, they tested the method by comparing measured values with historical data. Samples with known age was obtained from Pompeii (Italy) and a number of samples from Egypt (from the First Dynasty about 5000 years ago). They had a remarkable good agreement – which showed that the method was useful.



Willard Frank Libby
(1908 – 1980)

Libby was born in Colorado and educated as a chemist. He was professor in chemistry at the Berkeley University. After the war he was professor at University of Chicago (now the Enrico Fermi Institute for Nuclear Studies).

Libby worked and developed the technique to use C-14 for dating and this earned him the Nobel prize in Chemistry in 1960.

Nobel Prize in Chemistry 1960

To Willard F. Libby

"for his method to use carbon-14 for age determination in archaeology, geology, geophysics, and other branches of science".

C-14 emits β -particles. The energy is rather small (max. 156 keV) and the half-life of 5730 years is relatively long. Consequently, the number of disintegrations is small, and the usual C-14 dating method requires rather large samples (many grams) in order to yield enough radiation to provide a high degree of certainty in the age determination.

The major developments in the radiocarbon method up to the present day involve improvements in measurement techniques. The initial method has been replaced with the "gas counting method" and "liquid scintillation counting"

The ordinary carbon dating was based on the measurement of β -particles from the C-14 atoms that disintegrate during measurement. In order to yield an activity of 1 Bq the sample must contain 260 billion C-14 atoms (this can easily be calculated using the equations in this chapter). Consequently, if one could observe the **total amount of C-14 atoms** in a sample (not only those disintegrating per second), both the sensitivity and the age determination would be improved. This is the idea behind the AMS-method (Accelerator Mass Spectrometry) which was introduced in 1977. The method involves a mass spectrometer, that detects C-14 atoms based on their atomic mass.

Thus, the total number of C-14 atoms are observed, not only those that disintegrated during the observation period. With this technique, it is possible to date very small samples (a few milligrams).

Some problems

One important requirement was that the content of C-14 at the point of death was a constant. This relies on the assumption that the production of C-14 in the atmosphere is constant. Today we know that the rate of C-14 production exceeds the rate of decay. Several reasons have been proposed such as atmospheric nuclear testing. We assume that before the industrial revolution, the rates should have been at steady-state. It has therefore been important to find and use a sample from early in the 19th century as a reference sample.

Speculations such as variation of the earth's magnetic field could affect the flux of cosmic rays and consequently the C-14 production.

The method with C-14 for dating is useful for about 10 half-lives – or about 60 000 years.

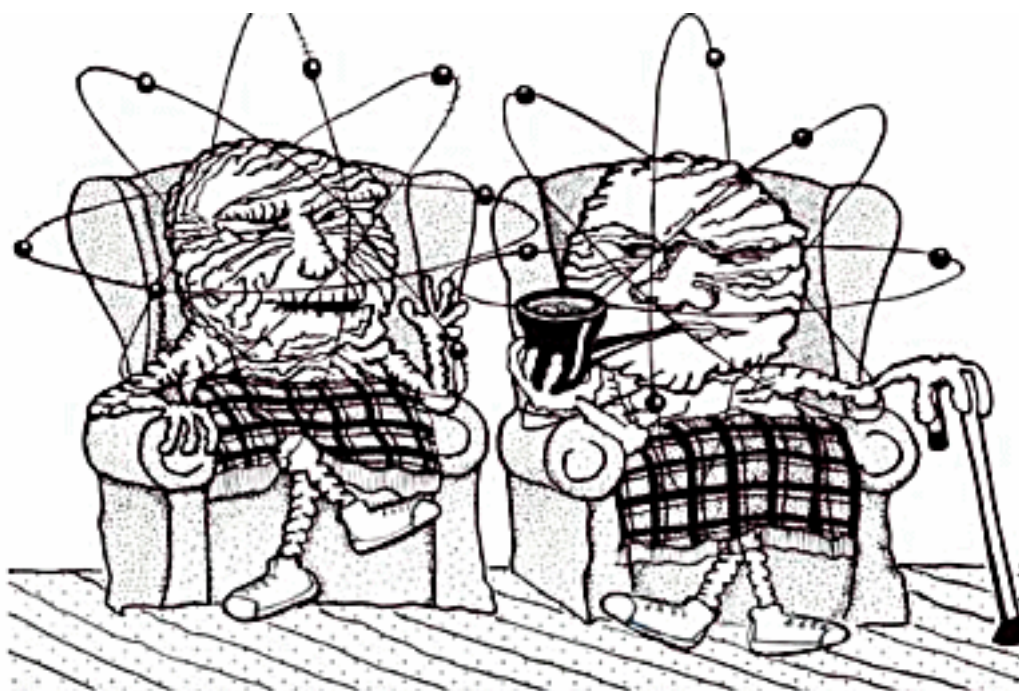

"When I was young I used to feel so alive, so dangerous! In fact, would you believe I started life as a Uranium-238? Then one day I accidentally ejected an alpha particle....now look at me, a spent old atom of Lead-206. Seems that all my life since then has been nothing but decay, decay, decay..."



Irene and Frederic Joliot-Curie

Chapter 4

Artificial Radioactive Isotopes

The Discovery

It was mentioned earlier that Irene Joliot-Curie and her husband Frederic Joliot-Curie was awarded the Nobel prize in Chemistry in 1935. The prize was given "in recognition of their synthesis of new radioactive elements".

Let us see more into the details of this experiment.

Irène and Frederic Joliot-Curie had a large supply of polonium, after Irene's parents. The polonium emitted alpha particles which they used to bombard different elements. In 1933 they used alpha particles and bombarded an aluminum plate. When they removed the α -particle source, it appeared that the aluminum plate emitted radiation with a half-life of approximately 3 minutes. The explanation was that the bombardment had resulted in a nuclear reaction. The α -particle penetrated the aluminum nucleus and changed it into phosphorus by emitting a neutron. The new phosphorus isotope was radioactive and was responsible for the observed radiation. Its designation is P-30.

This nuclear reaction may be written as follows:

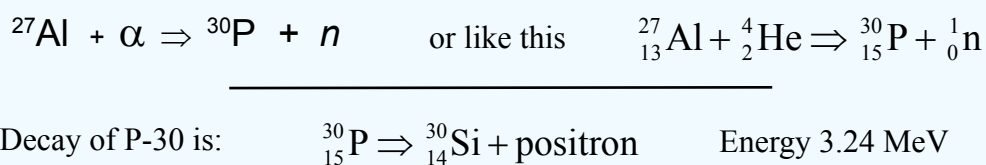

The neutron emitted can be observed as long as the bombardment takes place, but disappears immediately when the α -source is removed. However, the phosphorus isotope is radioactive. The decay mode is positron emission as shown above. The half-life is 2.5 minutes.

Irene and Fredric Joliot-Curie used their alpha bombardment technique on some other elements and found that it was possible to transform an element into another, with a higher number of protons in its nucleus. They announced this breakthrough to the Academy of Sciences in January of 1934 – and received the Nobel prize the year after. It can be mentioned that Marie Curie died July 1934 and was thus able to follow this exciting research almost up to the third Nobel prize in the family.

Radioactive isotopes are made!

Radioactive isotopes can be made by bombarding an element with a particle (α -particle, deuteron, proton, electron, neutron and even high energy x-rays). The neutron is the most efficient.

In general, the probability of a reaction depends on the energy of the particle – and it is measured in the so called "*reaction cross section*". It appears that neutrons with low energy (slow neutrons) in general have a larger cross section than fast neutrons.



In the mid 1930's, several laboratories had developed equipment, such as the accelerator called cyclotron, to bombard stable atoms with protons, deuterons and α -particles and found that new isotopes were formed. Some of these isotopes were radioactive.

Since protons, deuterons and α -particles are charged, they will mainly be scattered (because of Coulomb interaction) when approaching the positive nucleus of an element. Because of this, and since the techniques available for accelerating particles in the 1930-ties was rather poor, it was impossible (with the available energy) to transform elements with atomic number above 20 .

Use of neutrons – discovery of the efficiency of slow neutrons

A very efficient particle that can be used for bombardment is the neutron. This particle has no charge and will consequently not be influenced by the electric field around the atomic nucleus. The neutron readily penetrates the atomic nucleus with the result that new isotopes are formed.

In Rome, Italy, a small group of excellent scientists (Amaldi, d'Agostino, Pontecorvo, Rasetti, and Segré), headed by Enrico Fermi, used neutrons for bombardment. The neutron source consisted of beryllium powder and radon in a small glass bulb (the α -particles from radon hit beryllium with neutrons as a result). With this relatively strong neutron source they bombarded a number of heavy elements and observed numerous new radioactive isotopes. They assumed that they found both element 93 and 94 (see later).

During these experiments Fermi made an important observation. He found that when the source was surrounded by paraffin or water, the efficiency of the neutrons increased by up to 100 times. Consequently, when the neutrons were slowed down by collisions with hydrogen atoms, they become more effective. *Slow neutrons* yield a larger cross-section for many reactions than fast neutrons. With this technique they observed several hundreds new isotopes. These experiments from the 1930-ties earned Fermi the Noble prize in physics for 1938.



Enrico Fermi
(1901 – 1954)

Enrico Fermi was one of the top scientists of the 20th century. He discovered in 1926 the statistical laws, nowadays known as the «Fermi-Dirac-statistics». In 1927, Fermi became Professor of Theoretical Physics at the University of Rome (a post which he retained until 1938, when he – immediately after he received of the Nobel Prize – emigrated to America, primarily to escape Mussolini's fascist dictatorship).

In 1934 he presented his explanation of the β -decay (a paper that was first not accepted in Nature). He then carried out the work with neutrons that earned him the Nobel prize.

In USA he was in charge of the work that led to the first controlled nuclear chain reaction – the reactor on a squash court situated beneath Chicago's stadium.

Today we have several things with his name – such as element number 100 which is called Fermium, "The Fermi National Accelerator Laboratory" and "The Enrico Fermi US Presidential Award", which was started in 1956.

Noble prize in physics 1938

To Enrico Fermi

"for his demonstrations of the existence of new radioactive elements produced by neutron irradiation, and for his related discovery of nuclear reactions brought about by slow neutrons"

Reactors are excellent sources of neutrons and are used for the production of radioactive isotopes needed for biomedical research and the treatment of disease. Also a number of accelerators are used for the formation of particular radioactive isotopes.

The number of artificial isotopes increased rapidly in the years after 1934. Thus, by 1937, approximately 200 isotopes were known, in 1949 the number was 650 and today more than 1,300 radioactive isotopes have been produced.

Fission

A short history

James Chadwick discovered the neutron in 1932, and this initiated a number of research projects. The goal was to make and identify the isotopes formed when neutrons penetrate various atomic nuclei. We mentioned above that Fermi used neutrons for this purpose. In 1934 he observed β -particles when he bombarded uranium. Fermi's interpretation was that he had made a transuranic element – like 93. This interpretation was questioned by the German chemist **Ida Noddack**. In a famous paper, "*Über das Element 93*" published in "Zeitschrift für Angewandte Chemie" in 1934. Noddack suggested a

number of possibilities such as "it is conceivable that the nucleus *breaks up into several large fragments*, which would of course be isotopes of known elements, but would not be neighbors of the irradiated element." In this way Ida Noddack suggested a nuclear fission – which was found a few years later. Since however, she presented no theoretical or chemical basis for this possibility, the paper was more or less ignored at that time.



Ida Noddack
(1896 – 1978)

At The Kaiser Wilhelm institute in Berlin **Otto Hahn, Lise Meitner and Fritz Strassmann** worked with uranium and neutron bombardment. This research resulted in the conclusion that uranium can be split in two large fragments when bombarded with neutrons (see illustration below).

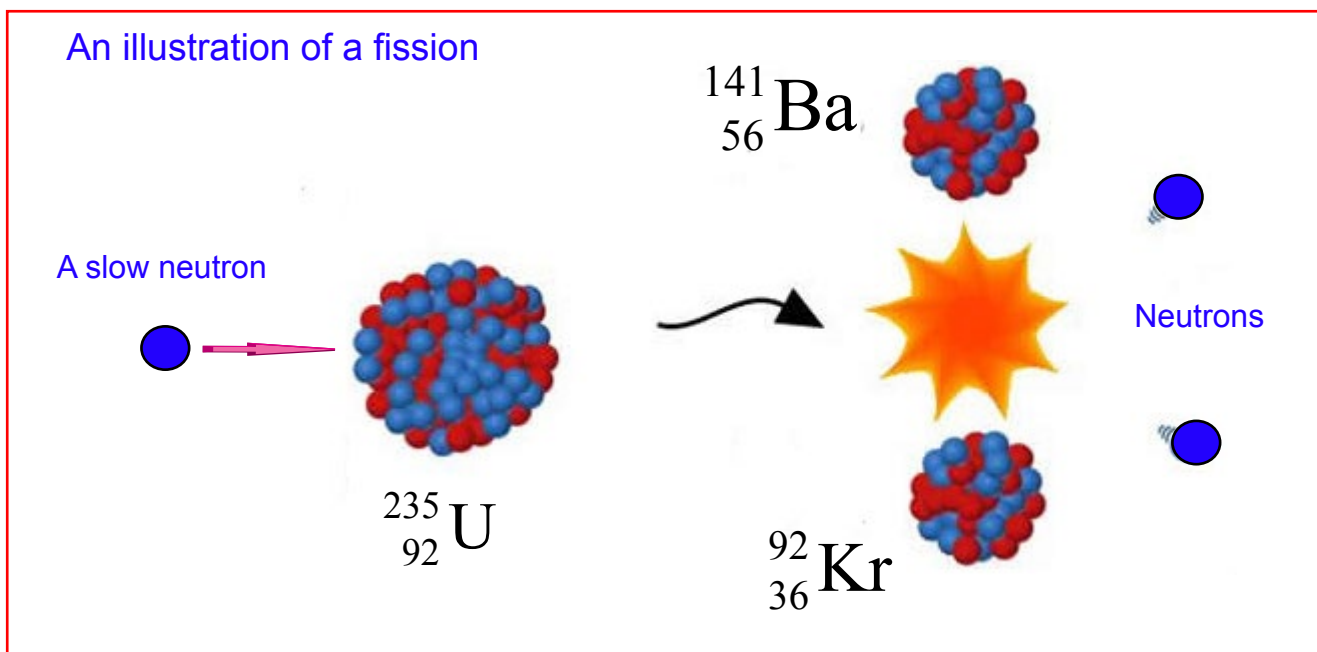

Lise Meitner, was an important member of the small group in Berlin. She and Otto Hahn had a lot of discussions in the summer of 1938 – when the political situation in Germany became more and more difficult for Lise Meitner. She was of Jewish ancestry and had lost her Austrian citizenship after the Anschluss and was at great risk. Otto Hahn, Niels Bohr and Dutch physicists were able to help Lise Meitner to escape via the Dutch border and go to Sweden. Here she took up a post at Manne Siegbahn's laboratory.



Lise Meitner
(1878 – 1968)

Hahn and Strassmann continued the experiments in Berlin and showed in an experiment on the 17th of December 1938, that it **was not possible to separate barium from the compound formed** when uranium was hit by neutrons. On the 19th of December, Otto Hahn wrote a letter to Meitner about the latest results. He ended his letter with the sentence: "*Perhaps you can suggest some fantastic explanations*".

Lise Meitner travelled to Kungälv (just north of Göteborg) to spend the December holidays together with some of her family. Here she met her young nephew **Otto Frisch** who worked with Bohr. One day they sat on the trunk of a tree, discussing the barium mystery. Using the the nuclear model of Bohr (the so called liquid drop model) as a basis, they calculated that if a neutron penetrated the nucleus, it could set up oscillations that would split the atom - *fission was possible!*

Maybe it can be said that the atomic age started on a timber log north of Göteborg during the December holidays of 1938. Hahn and Strassmann published their experiments in the German Journal *Naturwissenschaften*. Meitner and Frisch published their theoretical calculations in the British Journal *Nature* and Bohr let the news explode at a conference in the United States in January 1939.

It was however Otto Hahn – and only him – that was awarded the Noble prize for this discovery.



Otto Hahn
(1879 – 1968)

Hahn started to work together with Lise Meitner already in 1907 – and this collaboration lasted for more than thirty years. They identified several radioactive isotopes.

Following the discovery of artificial radioactivity by Joliot-Curie and the use of neutrons by Fermi for atomic nuclear processes, Hahn, Meitner and later Fritz Strassmann collaborated on the project that resulted in the discovery of fission.

Otto Hahn have been considered as "the father of nuclear chemistry". He started early to work on the chemistry of radioactive isotopes. He became professor in 1912 and then head of The Radioactivity Department of Kaiser Wilhelm Institute for Chemistry in Berlin.

Nobel prize in chemistry 1944

To Otto Hahn
"for his discovery of the fission of heavy nuclei".

Isotopes formed by fission

The splitting of a heavy atomic nucleus, such as U-235, occurs because of intrinsic instabilities when a neutron enters. There are numerous pathways by which the nucleus emits energy and creates new products. The fission products formed are very unstable and undergo β -decay to form new products. More than 200 fission products are known. The products formed can be divided into two groups, one "heavy" group with an atomic weight of about 130 – 140 mass units and one "light" group with an atomic weight of 90 – 100 mass units. See illustration on next page.

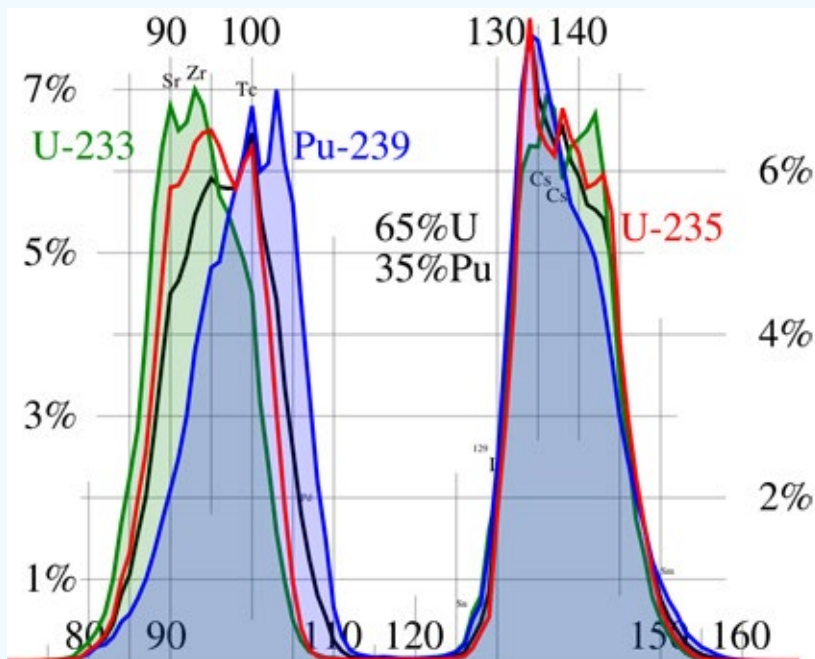

Here is a figure that shows the yield of fission products for U-235 (red), U-233 (green), Pu-239 (blue) and a mixture of U and Pu (black). Two elements are formed in each fission. The two elements are not equal in mass. The average mass of the lighter element is between 90 and 100 atomic units and of the heavier element is between 130 and 140 atomic units. The distribution is shown by the graph. The vertical-axis indicate the yield.

A large amount of energy is released in the fission process. Most of the energy is released directly during the process of fission but a small amount is released at a later stage by those fission products that are radioactive. Most fission products have short half-lives. However, unstable daughter products have longer and longer half-lives.

From an environmental point of view, Cs-137 and Sr-90 are the most important fission products of U-235. They have a half-life of about 30 years, which is important with regard to storage and disposal of these products. The fission process leads to three different types of radioactive isotopes: *fission products*, *transuranic elements*, and *activation products*.

Table 4.1: Some important fission products

The Light Group			The Heavy Group		
Isotope	Symbol	$t_{1/2}$	Isotope	Symbol	$t_{1/2}$
Krypton-85	Kr-85	10.7 yr	Tellurium-129m	Te-129m	33.6 d
Strontium-89	Sr-89	50.5 d	Iodine-131	I-131	8.04 d
Strontium-90	Sr-90	29.1 yr	Xenon-133	Xe-133	5.3 d
Yttrium-91	Y-91	58.5 d	Cesium-137	Cs-137	30.0 yr
Zirconium-95	Zr-95	64 d	Barium-140	Ba-140	12.7 d
Technecium-99	Tc-99	213,000 yr	Praseodymium-143	Pr-143	13.6 d
Ruthenium-103	Ru-103	39.3 d	Neodymium-147	Nd-147	11.0 d
Ruthenium-106	Ru-106	368 d	Promethium-147	Pm-147	2.6 yr

1. Fission products

There are a large number of fission products, and some of the most important ones are given in the table above. In the first period after fission occurs isotopes with short half-lives dominate, i.e. Zr-95 and I-131. Later, Sr-90 and Cs-137 are predominant.

2. Transuranic elements

Transuranics are elements with an atomic number larger than 92 (uranium). Most transuranic elements are made in accelerators when heavy atoms such as uranium are bombarded with neutrons, deuterons or – other small charged particles. Thus plutonium was first produced and isolated in 1940, by Glenn T. Seaborg, Edwin McMillan and colleagues by deuteron bombardment of uranium in the 60-inch cyclotron at the University of California, Berkeley. They shared the Nobel prize in chemistry in 1951 for the discovery of the transuranium elements. Plutonium is also formed when U-238 absorbs a neutron and subsequently emits two β -particles. In a reactor this process can produce large amounts of plutonium.



McMillan and Seaborg

In addition, it can be noted that the transuranic elements are usually α -particle emitters, whereas the fission products are β -particle emitters. This implies that when the transuranics come into the body, through inhalation or ingestion, they deposit all their energy within the body. Thus, transuranic elements may be a health concern.

3. Activation products

The third type of radioactive isotopes which may be produced in combination with reactors and nuclear weapons, are activation products. These radioactive isotopes are formed when stable isotopes are bombarded by neutrons. Co-60 is an activation product formed when Co-59 absorbs a neutron. Likewise, Cs-134 is formed from Cs-133 by neutron capture. The materials around a reactor or a nuclear bomb explosion can be made radioactive by neutron capture.

If a nuclear bomb detonates in the atmosphere, large numbers of neutrons will be released. They can then react with stable atoms such as N-14. In this way the radioactive isotopes H-3 and C-14 are formed.

If the detonation takes place just above the ground, large amounts of materials (earth, rocks, building materials, etc.) will be activated and vaporized in the “fireball” which is formed. Such nuclear tests yield large amounts of radioactive fallout.

The use of neutrons to form new radioactive elements can also be used in research to attain new and valuable information. This will be mentioned under "activation analysis".

Plutonium

Few radioactive isotopes have attracted more interest than plutonium – a transuranic element with atomic number 94. Several plutonium isotopes exist. Thus, we have Pu-238 (half-life 87.7 years), Pu-239 (24,400 years), Pu-240 (6,570 years) and Pu-241 (14 years). Pu-239 is the best known and its environmental impact has been heavily debated during the last decades. It is formed in a reactor (see the illustration below) after neutron bombardment of U-238. Pu-239 sits in the spot light because it is not only a cost effective fuel used in fission reactors but also, it is a key ingredient in nuclear weapons.

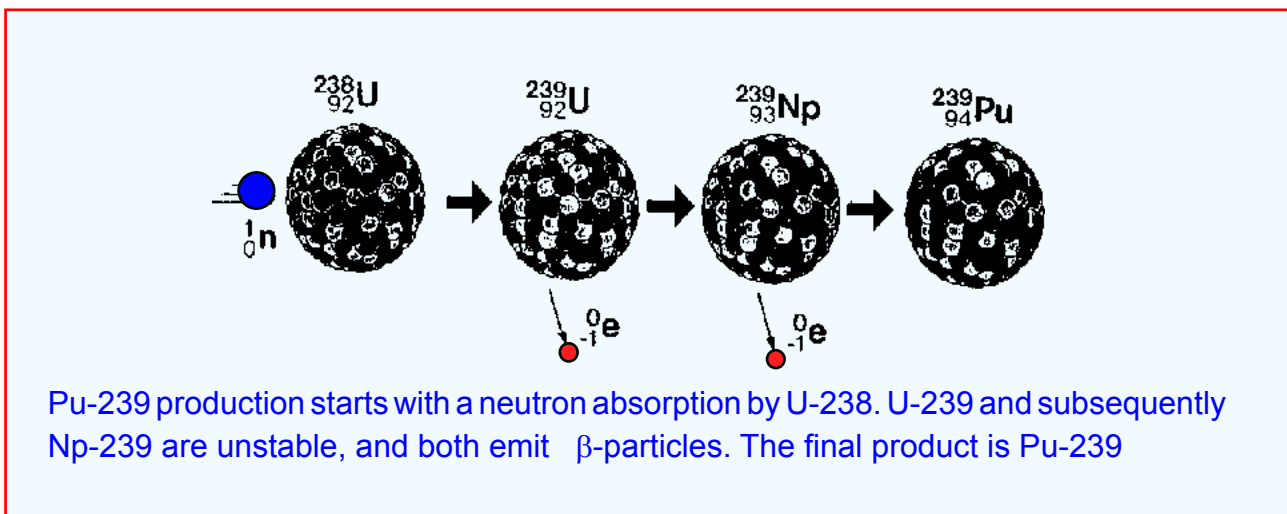

With regard to the environment, Pu-239 is the most important of the plutonium isotopes. It emits an α -particle with an energy of 5.15 MeV. In air, these α -particles have a range of a few cm, whereas, in tissue, the range is less than one mm.

The following important conclusion can be made from this: *plutonium has a minor influence on a person's health when it is outside the body since the emitted α -particles will not enter the body.*

On the other hand, if plutonium enters the body all the emitted α -particles will deposit their energy within the body.

Large amounts of plutonium have been released to the atmosphere due to atmospheric nuclear tests. It has been estimated, that for the period 1945 to 1974, approximately 400,000 Ci or $1.5 \cdot 10^{16}$ Bq Pu-239 were released – corresponding to 6.5 tons. As a consequence, plutonium is now found in nature. The fallout of plutonium is approximately as fast as that for strontium (Sr-90). The ratio between plutonium and strontium fallout has been rather constant since the large weapon tests ended in 1963. Calculations show that the total fallout on the Northern hemisphere is approximately 50 Bq per square meter.

Plutonium entering the body via the food chain represents a small radiation problem since only 30 ppm is absorbed in the blood from the intestine. However, the plutonium which enters the body via inhalation (such as those attached to dust particles in the air) presents a more serious problem.

Activation Analysis

The activation of certain materials by neutron irradiation is an elegant analytical method for identifying chemical species. When a compound is irradiated with neutrons, many elements are activated and become radioactive. The radioactivity can be measured easily and the properties of the radiation can be used to identify an element. Thus, it is possible to observe with excellent sensitivity about 70 elements. In some cases, multi-element analysis at the ppm level for up to 30 elements can be accomplished with a sample weighing less than a gram.

It is a type of analysis which do not destroy the sample and it is used by archaeologists to obtain important information about old coins, pieces of ceramic pots, and other relics.

Napoleon

Criminologists use activation analyses in the solution of criminal cases. One example that has been heavily debated is the activation analysis which showed that the hair of Napoleon contained arsenic (work in the 1960-ties). This suggested the possibility that Napoleon was murdered. However, it is possible that the arsenic could have come from his environment. At that time, arsenic was used in wall coverings and could have been picked up by touch or given off into the atmosphere.

New experiments carried out in 2007 seem to prove that more than 97% of the arsenic found in the hair of Napoleon is in inorganic form, which is consistent with a chronic intoxication by the most toxic inorganic arsenic species.

Rocks from the moon

It is also of interest to mention that when the composition of the moon was determined, the analysis was assisted by neutron activation. Rocks, brought back to Earth by the astronauts, were bombarded by neutrons, forming radioactive products. The subsequent radioactive emissions were then used to identify elements in the moon rocks.

Women in nuclear chemistry

For all those that have followed this short glimpse of history into the field of radioactivity and the formation of radioactive isotopes may have noticed that a surprisingly large fraction of the scientists are women. Remember this research took place between 1900 and 1940. In the foregoing we have tried to mention their work – and we would like to end this chapter by lining them up again. The women are: Marie Curie, Irene Joliot-Curie, Ida Noddack and Lise Meitner.



Marie Curie



Irene Joliot-Curie



Ida Noddack



Lise Meitner

These four ladies were forerunners in nuclear chemistry and led us into the atomic age.

One of Marie Curie's students was the Norwegian Ellen Gleditsch. She came to Paris in 1907 and joined the Curie - group. She later introduced nuclear chemistry to Norway. Furthermore, she was very much involved in the purchase of four grams of radium – that was the foundation of the Norwegian Radium Hospital in 1932.



Ellen Gleditsch
(1879-1968)



Ellen Gleditsch in a photo from 1912. She had just obtained the degree "Licenciée ès Sciences".



Photo from 1957

Louis Harold Gray

He is honored by calling the physical dose unit "gray*" – abbreviated Gy



Bq = becquerel
Gy = gray
(Sv = sievert)

Chapter 5

Activity and Dose

The activity of a radioactive source

When an atom disintegrates, radiation is emitted. If the rate of disintegrations is large, the radioactive source is considered to have a high activity.

The unit for the activity of a radioactive source was named after Becquerel (abbreviated Bq) and is defined as:

$$1 \text{ Bq} = 1 \text{ disintegration per sec.}$$



In a number of countries, the old unit, the curie (abbreviated Ci and named after Marie and Pierre Curie) is still used. The curie-unit was defined as the *activity in one gram of radium*. The number of disintegrations per second in one gram of radium is 37 billion. The relation between the curie and the becquerel is given by:

$$1 \text{ Ci} = 3.7 \cdot 10^{10} \text{ Bq}$$



The accepted practice is to give the activity of a radioactive source in becquerel. This is because Bq is the unit chosen for the system of international units (SI-units). But one problem is that the numbers in becquerel are always very large. Consequently the activity is given in kilo (10^3), mega (10^6), giga (10^9) and tera (10^{12}) becquerel. If a source is given in curies the number is small.

For example; when talking about radioactivity in food products, 3,700 Bq per kilogram of meat is a large number and consequently considered to be dangerous. If however, the same activity is given in Ci, it is only 0.0000001 curie per kilogram – *"nothing to worry about?"*.

Intensity of radioactive sources

Most people are used to measuring the amount of a substance in kilograms or liters, not in becquerels or curies. If we are using the best balances in the world, we can accurately measure down to about one microgram of substance (10^{-6} gram). By using our knowledge of radioactive detection, amounts more than a million times smaller than this can be measured. Radioactive sources as small as 10 – 100 Bq can be readily measured; which corresponds to only about 10^{-14} gram.

Some examples

Around 1930, radium sources were introduced in many hospitals and used for cancer therapy. In spite of the fact that radium and its daughter nuclides emit α -particles and β -particles, it is the accompanying γ -radiation that is used for treatment. Examples are given below.

In the first example the source consists of a number of needles filled with radium (in the milligram range). In the other example all radium is in one source (3 gram radium). This gives rise to the two types of treatment; brachytherapy and teletherapy.

An example of brachytherapy

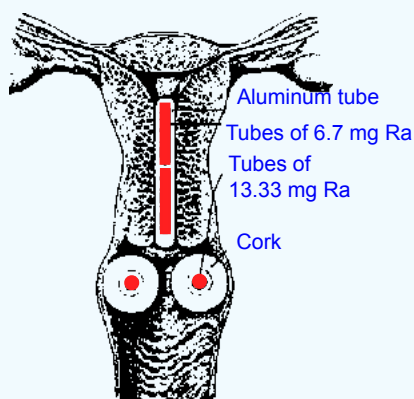

The drawing to the left is from 1931 and demonstrates the treatment of a cervical cancer by using small needles containing radium. The needles can be placed in quite close contact with the tumor.

Cork containers are used for the vaginal sources and a cylindrical tube for the uterine sources. The source in the example is all together 40 millicurie – or 1480 mega Bq (MBq) – 1.48 million Bq.

In some cases, the needles with radium were melted into solid paraffin and placed directly on the skin of the patient.

An example of teletherapy

In the period from 1930 up to about 1960, radium was used for cancer treatment. Then the radium sources were exchanged with Co-60 or Cs-137 sources – and high energy accelerators (Betatrons and Linear accelerators). In the period with radium, a number of hospitals around the world, were called Radium Hospitals. In Norway the Radium hospital was opened in 1932 – based on a radium source of 4 gram. One gram was divided in a number of small needles and used for brachytherapy. The rest – 3 gram – was used for teletherapy – and was called "*The radium cannon*". See picture next page.

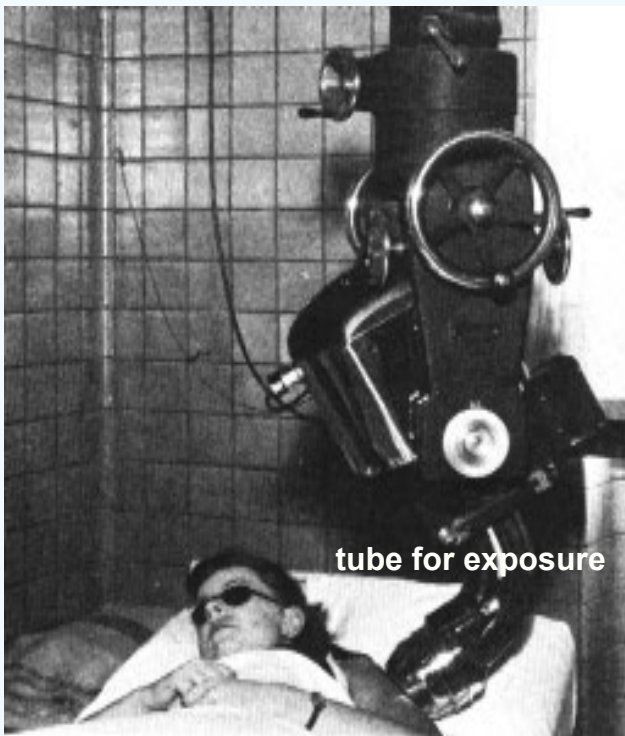

The source consisted on 3 gram radium; that is 3 Ci or 111 GBq (1 GBq = 10^9 Bq).

The source was kept in a lead container when not in use. For treatment the source was brought into the exposure position – approximately 10 cm from the skin. A treatment lasted for about 45 minutes. The dose given was of the order 2 Gy (see later in this chapter).

The treatment time was quite long for the patients since they could not move out of position during the treatment. With stronger sources the treatment time was reduced considerably.

Smoke detectors

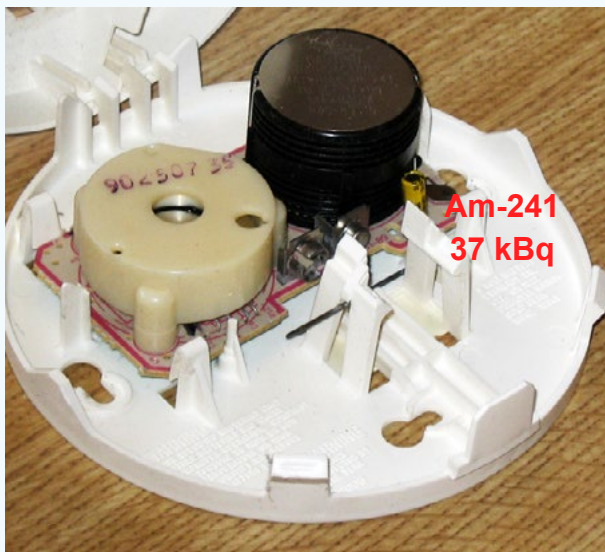

To the left you see a modern smoke detector. The detector (the round black box) consists of a radioactive source – which emits α -particles into a small air chamber between two electrodes. The particles ionizes the air and a current of ions go from one electrode to another.

When smoke particles come into this small air chamber, they will absorb the α -particles. The number of ions formed as well as the current will go down and the alarm goes!

The radioactive source consists of Am-241 with an intensity of about 35 kBq. Americium is a transuranic element with atomic number 95. The

isotope Am-241 decays via an α -particle (energy of about 5 MeV) and some very weak γ -rays. The half-life is 432 years. We can write this decay as follows:

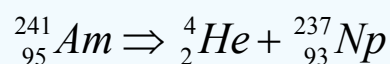

It is seen that americium decays into neptunium – which in turn is a radioactive isotope. However the half-life for the neptunium isotope is 2.2 million years – which implies that this isotope in practice is stable.

The isotope used in smoke detectors is harmless to people (unless you eat it) and also harmless to the environment.

Specific Activity

Specific activity is the activity per mass or volume unit. For example, the radioactivity in meat is given as **Bq/kg**. For liquids the specific activity is given in **Bq/l** and for air and gases the activity is given as **Bq/m³**.

In the case of fallout from a nuclear test or accident, the activity on surfaces can be given either as Bq/m² or as Ci/km². Both are used to describe radioactive pollution. The conversion between them is:

$$1 \text{ Ci/km}^2 = 37,000 \text{ Bq/m}^2$$

It is necessary with information – and you still have a long way to go in order to calculate radiation doses and risk factors associated with these specific activities. The information must include the specific activity along with the various types of isotopes, their energies, physical and biological half-lives and methods of entry into the body. After considering all of these factors, a determination of risk can be estimated.

Radiation Dose

So far we have discussed the intensity of a radioactive source – i.e. the number of Bq. Radioactive sources represents no biological risk as long as they are isolated from the environments. However, when people (or another biological system) are exposed to radiation – a radiation dose is delivered.

It is therefore important to distinguish between the activity of a radioactive source (measured in becquerels) and the radiation dose which may result from the source. The radiation dose depends on the location of the source with regard to those exposed. Furthermore, the radiation dose depends upon the type of radiation, such as whether it is α -, β - or γ -rays and the energy of the radiation.

Although people can neither see nor feel radiation, it is known that radiation deposits energy to the molecules of the body. The energy is transferred in small quantities for each interaction between the radiation and a molecule and there are usually many such interactions.

For anything that is irradiated, the temperature rises. Additional radiation increases the temperature further. The temperature increase occurs because the radiation energy is transformed into heat. Even though it is generally very difficult to detect the rise in temperature, the realization that heat is generated by radiation is a key element in understanding the concept of *radiation dose*.

Radiation dose measures the amount of energy deposited in an irradiated compound.

Radiation dose is measured in units of gray (Gy)

1 Gy = 1 joule absorbed energy per kg

L. Harold Gray (1905 - 1965) was one of the great pioneers in radiation biology. He obtained his PhD in 1930 at the Cavendish Laboratory under Rutherford at a time when the laboratory was a world centre for fundamental research in atomic physics. Gray's first paper was "*The absorption of penetrating radiation*".

Gray worked as a physicist at Mount Vernon Hospital, and became interested in the effect of oxygen on radiosensitivity. Cells with a low content of oxygen (hypoxic cells) are less sensitive to radiation compared to normal cells. This behavior has caused problems for the treatment of cancer, because most tumors contain regions with hypoxic cells.

The LH Gray Memorial Trust was set up in 1967 to honour the memory of Hal Gray. Also L. H. Gray Conferences and Workshops have become established as prestigious meetings at which a high level of presentation and discussion take place.



A private picture from 1957. Here we are outside Grays institute at Mont Vernon hospital – from left; John Boag, Målfrid Henriksen (wife of the author) and Hal Gray.

Dose Units and Their History

In the course of the 100 years of dealing with ionizing radiation, several different dose units have been used. Some of these units are still used in different countries. It is useful, therefore, to consider some of these units and to see the relations between the old units and the gray unit (Gy).

- ***Skin erythema dose***

It was discovered early that radiation exposure resulted in reddening of the skin. For a long period this reddening was used to quantify the radiation. This was called the *skin erythema dose*. This unit was quite uncertain since the reddening of the skin varied from one person to another. Another drawback was that the reddening appeared some time *after* the exposure.

In the case of ultraviolet radiation, this dose unit (along with the attending uncertainties) is still in use. The smallest UV-dose resulting in the reddening of the skin is called **MED**, which is an abbreviation of *minimum erythema dose*.

- ***The Roentgen unit***

People who worked with radiation around 1920 began searching for a more precise dose unit and in 1928, the *roentgen unit* (abbreviated R) was adopted. This unit can not be used for the dose itself since it is actually a measure of radiation exposure, i.e. the ionization of air molecules.

In the original definition 1 R means the amount of x- or γ -radiation that is required to liberate positive and negative charges of one electrostatic unit of charge (esu) in 1 cm³ of dry air at standard temperature and pressure (STP). This corresponds to $2.58 \cdot 10^{-4}$ coulomb per kg of ions generated in air.

To calculate the radiation dose (in Gy) from an exposure of 1 R depends on the energy of the x- or γ -radiation and the composition of the irradiated material. For example, if soft tissue is exposed to γ -radiation of 1 R, the radiation dose will be approximately 9.3 milligray (mGy).

- ***The Rad Unit***

In 1953, the dose unit *rad* was developed. This is an abbreviation for *radiation absorbed dose* and is defined as:

***The amount of radiation which yields an energy absorption of 100 erg per gram
(i.e. 10^{-2} joule per kg).***

The rad unit is still used in several countries.

From this you can easily see that both gray and rad are defined as energy absorbed – the relation between the two are:

$$1 \text{ gray} = 100 \text{ rad}$$

In this book, the gray is used most of the time. But use of the rad is difficult to avoid due to its pervasive use in the older literature. The SI-system of units uses the gray.

Relative biological effectiveness (RBE) and equivalent dose

When a **biological system** is irradiated with different types of radiation (x- and γ -radiation, α -particles, neutrons and/or heavy ions) the biological end result – **for the same dose given in Gy** – may vary. This is a puzzle, since the primary products, ions and excited molecules, are the same.

The answer to this puzzle is connected to the spatial distribution of the primary products. Thus, for x- and γ -rays the primary products are evenly distributed, whereas in the case of protons, α -particles and heavy ions, the primary products are found along the **track of the particle**. An illustration of this is found below. (See also Chapter 2, pages 28 – 29).

The distribution of ions and excited molecules vary with the type of radiation

Electrons,
x-rays and γ -rays

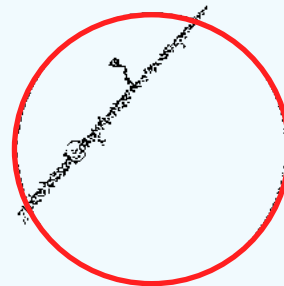
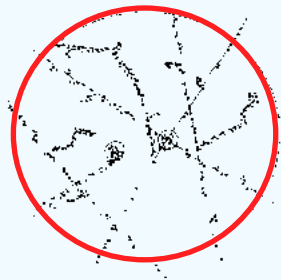

Track of an
 α -particle

In the illustration above the ions and excited molecules are indicated by dots – i.e. the dots represent small amounts of energy absorbed. To the left is presented the situation for x-rays, β -particles and γ -rays, whereas to the right is given the situation for an α -particle. In this case the ions are formed along a track – with smaller tracks branching off from the main track (they are called δ -tracks).

*The number of dots within the two circles is the same, indicating the **same** radiation dose measured in Gy. However, the distribution of dots is different. The situation to the left is an illustration of **low LET** (linear energy transfer); i.e. sparse ionization along the γ -ray track. The circle to the right is an illustration of **high LET**; i.e. a dense path of ionizations along the track.*

How can we find RBE ?

For the most simple biological end point, such as cell killing, we can do straight forward experiments.

A summary of such experiments are given on the next page. The reference radiation is x-rays with maximum energy 250 keV. Also Co-60 γ -radiation has been used (γ -energies of 1,17 and 1,33 MeV). For a given biological effect (for example 10 % killing), RBE is calculated from the following formula:

$$\text{RBE} = \frac{D_{x\text{-rays}}}{D_{\text{test}}}$$

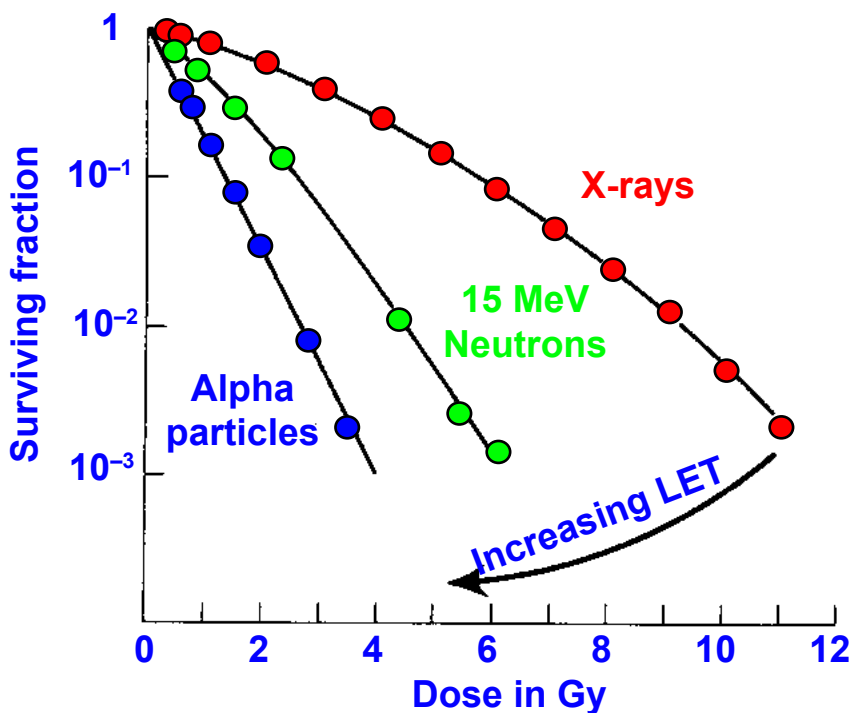

In this illustration is a summary of cell killing experiments. It is clear that the cell killing depends on the LET of the irradiation. Thus the efficiency increases with LET, going from x-rays to heavy ions. This is important for radiation therapy when protons and heavy ions like carbon ions are used.

You choose a certain end point, such as the 10 % survival (or another value) and give the x-ray dose to reach this endpoint and compare with the test radiation. Since most survival curves follow a linear quadratic curve, the RBE *decreases with increasing dose*.

Since we now use protons and other heavy ions in radiation therapy, it is important to have information of RBE (this will be more discussed in Chapter 10 on radiation therapy).

With regard to the mechanism for cell killing it seems to be a close connection between double strand DNA breaks and cell death. Consequently, the RBE yield information about the LET-dependence of double strand breaks.

What is the situation for other deleterious effects?

If we go to other biological endpoints it appears to be more difficult to determine the RBE. In the case of humans, most interest has been concerned on; a) genetic effects and b) cancer. For both these effects we assume that the start point is a DNA-damage. We do not know the particular type of damages and it is of course not possible to do experiments.

In the case of genetic effects a lot of work has been carried out with mice. Similarly, experiments have been carried out for radiation induced cancer in mice, rats and rabbits. However, no experiments include two or more different types of radiation (with different LET), and we have very little information about what the RBE-values to use.

The radiation authorities such as ICRP (*International Committee on Radiation Protection*) has solved the problems with RBE by introducing a new dose unit – "*the equivalent dose*".

The units within this system are called *rem* (in the cgs-system) and *sievert (Sv)* in the SI-system. The latter unit is given to honour the Swedish scientist Rolf M. Sievert.

The history of rem and Sv



The observation that cell killing efficiency depends on LET have in many ways changed the dosimetry. The radiation organizations discussed already in 1945 – just after the second world war, that it would be useful to introduce a new unit. The physical dose unit used then was the roentgen unit (R, see above). In 1947 the rem-unit was introduced. This unit was in 1950 defined as:

that dose of any ionizing radiation which produces a relevant *biological effect* equal to that produced by one roentgen of high voltage x-radiation.

In 1962 ICRP used rem as equivalent dose for the unit rad (see above).

In the 1970-ties the SI-unit system was adopted by the radiation world. Consequently, the radiation dose was given in Gy (gray) and the rem-unit was changed to Sv (sievert). The Sv unit should take care of the LET-dependence. Thus;

$$\text{Sv} = w_R \cdot \text{Gy}$$

w_R is a weight factor assigned to the radiation in question,
it is the RBE (relative biological efficiency).

The use of Sv

It should be remembered that Sv is not a physical dose unit that can be measured with dosimeters. The radiation dose is measured in Gy – and if a reliable RBE-value exists the equivalent dose in Sv can be observed.

If the radiation in question consists of x-rays, γ -rays, β -particles or a mixture of them (this is the case in most situations with radioactive isotopes) the RBE-value would be close to 1.0 – and this value is adopted by ICRP. If however α -particles or high energy particles of protons, neutrons and heavy ions are included we can obtain reliable RBE-values for cell killing. However, we have very little information about RBE-values in the case of other deleterious effects such as cancer.

*For radiation protection, ICRP has worked out a system that is used all over the world – and which will be given below. In this system are given dose units such as; **equivalent dose, effective dose and collective dose**. It has to be pointed out that the system is based on the LNT-model (linear with no threshold) for the biological radiation effects on humans.*

RBE-values given by ICRP



Radiation type	Weighting factor w_R
Photons	1
Electrons and muons	1
Protons and charged pions	2
Alpha particles, fission fragments, heavy ions	20
Neutrons	A continuous curve as a function of neutron energy

The curve for neutrons has, according to the previous recommendation (ICRP 1991) a value of 5 for energies below 10 keV, a value of 10 in the energy range 10 – 100 keV, – a value of 20 in the range 100 keV to 2 MeV, and finally a value of 5 for energies above 20 MeV.

It is very difficult to estimate the equivalent dose for a mixture of neutron energies as found for the cosmic radiation.

ICRP – UNSCEAR – Sievert



Rolf M. Sievert
(1896 - 1966)

Rolf M. Sievert played a significant role in establishing the international committees ICRP (International Commission on Radiological Protection) and UNSCEAR (United Nations Committee on the Effects of Atomic Radiation). He served for several years as director of the Swedish National Institute of Radiation Protection. Sievert constructed an ionization chamber for depth dose measurements (called Sievert chamber).

Sievert is honored for his work in dosimetry (the measurement of absorbed dose) by naming the unit for equivalent dose *sievert* (abbreviated Sv).

Effective Equivalent Dose

In some cases, only a part of the body is irradiated. For example, mainly the bronchi and lungs are involved in the case of radon and radon decay products. Different organs and types of tissue have different sensitivities with regard to what is termed the *late effects* of radiation. Late effects are biological responses that are only observed after a substantial amount of time has passed, often years. Induction of cancer is a late effect. In order to compare the risk for late effects of different types of radiation, the so-called *effective dose* is used.

If one part of the body (*e.g.*, the lungs) receives a radiation dose, it represents a risk for a particularly damaging effect (*e.g.*, lung cancer). If the same dose is given to another organ it represents a different risk factor.

In the LNT-model it is possible to calculate a dose given to the whole body that yields the same risk as that from the much larger dose given to one particular organ.

This calculated dose is called *the effective dose* (often shortened to simply *the dose*) and is designated *E*. It is defined in the following way:

$$E = w_1H_1 + w_2H_2 + \dots\dots\dots$$

Here w_1 represents a weighting factor for organ 1 and H_1 is the equivalent dose (given in Sv) for organ number 1, and so on. The weighting factors represent the sensitivity of a particular organ.

It can be noted that the "*effective dose*" involves two different weight factors;

- First, the radiation weight factor w_R and
- Second, the tissue weight factor w_T .

Both factors that are in use, are proposed by ICRP.

The ICRP values for the radiation weight factors w_R from 2007 are given in the table above. The tissue weight factors, suggested by ICRP in 2007, are given by the diagram on the next page.

The body has been divided into 15 different organs – each with a weighting factor w_T . If you add up all the weighting factors, you find that the total is 1 or 100 %.

One organ or tissue is called "remainder". The notion is used for the combined contribution from 14 different tissues – 13 for each sex and in addition prostate (for men) and uterus/cervix (for women).

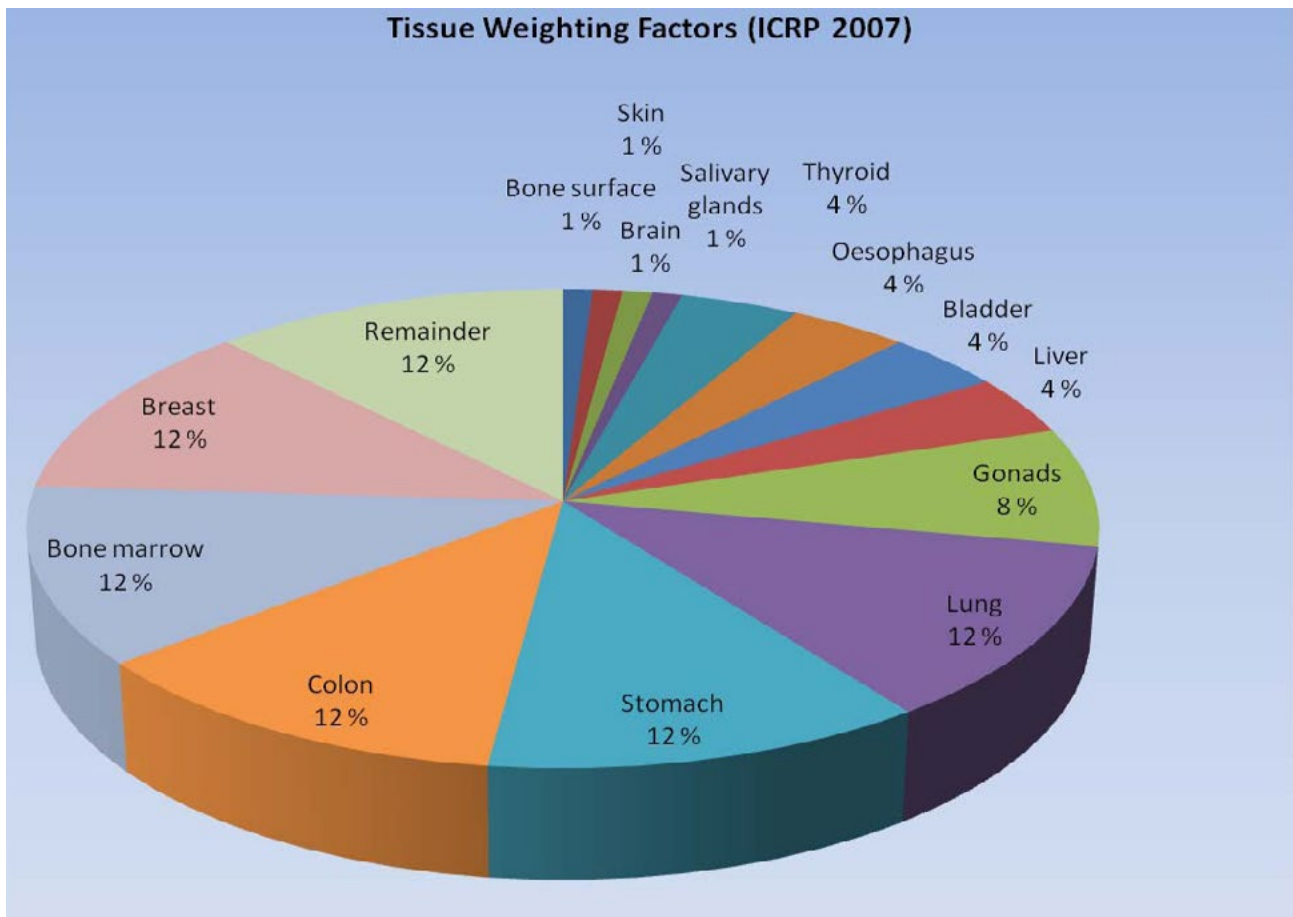

Other Dose Units used by ICRP

In addition to the units already defined, there are some other concepts used in radiation protection such as "collective dose" and "committed equivalent dose".

The above units together with the LNT-hypothesis have, in recent years been used by lay people, journalists, environment organizations and politicians in combination with assumptions of the total health effect of radiation accidents such as Chernobyl and Fukushima.

In the following we shall give a brief overview of the concepts used when working in radiation protection.

Collective dose.

The collective dose is the sum of all individual doses in a group of people. It can be obtained by the product of the average individual dose with the number of people in the group. For example in combination with mammography to a large group, the collective dose is calculated as the product of the single dose and number of women.

The unit used for the collective dose is person-sievert (person-Sv) or sometimes man-sievert.

Collective doses and the LNT theory always give scaring results. We shall return to this point when we discuss the radiobiology.

Committed equivalent dose

When a radioactive compound enters the body, the activity will decrease with time, due both to physical decay and to biological clearance, as noted earlier. The decrease varies from one radioactive compound to another. Accumulated dose over a certain period of time, usually 50 years, is called the committed equivalent dose.

Conclusion on Sv

1. The Sv unit is connected to man. It can not be used in biological experiments on animals, fish, plants, insects, etc.
2. The dose can not be measured in Sv-units. A large number of articles and opinions have been published where the dose is given in Sv. This is not possible!
3. The Sv (rem) units are concerned with "deleterious effects on man" and are based on the LNT-hypothesis. This hypothesis is rather doubtful – and recent radiobiological experiments are not in line with the LNT-view. Consequently, the present author would like to use the Gy (rad) units throughout the book.



Radiobiological work during the last 20 years have revealed that biological systems have a number of defense mechanisms such as repair, apoptosis and adaptive response. Furthermore it appears that these processes may be stimulated by radiation – particularly small doses given at a low dose rate. May be that we should be happy with the radiation around us – and may be we would profit on a higher background level. These interesting issues will be discussed.

How to count Bq and measure Gy ?

You can not measure Sv !

You need more than eyes and abacus.

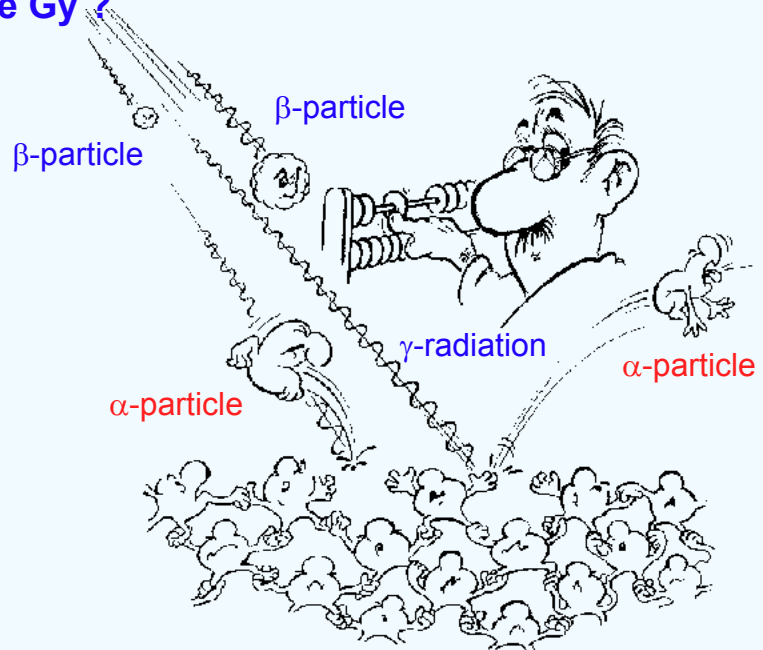

Chapter 6

The Measurement of Radiation

Introduction

In this chapter, the equipment and methods used for measuring ionizing radiation will be discussed. There are two types of instruments: counting equipment (used to determine number of becquerels and the radiation quality) and dosimeters (used to determine radiation dose). Both types of equipment require that *the radiations result in observable changes in a compound* (whether gas, liquid or solid).

Measuring equipment consists of two parts that usually are connected. The first part consists of a *sensitive volume*, consisting of a compound that experiences changes when exposed to radiation. The other component is *a device that converts these changes into measurable signals*.

The qualities of radiation that we want to measure are:

- **Activity.** The activity or intensity of a source is measured in becquerel. It can be given as the total activity or given in Bq/kg (solid), Bq/l (liquid) or Bq/m³ (gas). In considering pollution of an area Bq/m² is used. Some countries still use Ci/km².
- **Type of radiation.** It is important to distinguish between α - or β -particles, x- or γ -rays and neutrons.
- **The energy.** The energy is usually measured in the unit electron volt (eV). The energy of the particles or photons is important.

- **Dose** is the absorbed radiation energy measured in gray (Gy).
Correct measurement of dose is important in radiobiological experiments and within radiation therapy. We shall also discuss measurements of doses from natural sources.

Measuring equipment can vary in size and price. The equipment chosen depends on the purpose of the measurement, the sensitivity desired, and the precision necessary. The simplest type of measurement is to observe the amount of radiation hitting the sensitive volume or detector of the counter. If the sensitive volume is covered with plates of different thicknesses and composition, information may be obtained on the type of radiation. These instruments may be used to monitor radiation areas.

Exact measurements of radiation energy are more complex and different equipment is required. The energy of the radiation may be used to identify a particular isotope. If several isotopes are mixed together (for example, fission products), it is possible to identify the separate isotopes by an accurate determination of the energy of the particles or photons emitted. For that purpose, equipment is needed which has *good energy resolution*.

X-and γ -rays that hit the sensitive volume may pass through it without being absorbed. Consequently, the sensitive volume must be large enough to absorb sufficient amounts of this type of radiation. The greater the energy, the larger the volume. If a significant fraction passes through the sensitive volume without interacting, and therefore without detection, the equipment has a *low efficiency*.

If the sensitive volume contains heavy atoms, the possibility of interaction, and thus the probability of being detected, is greater. Heavy atoms are most effective in stopping x -, γ -, α -, β -, and cosmic-rays. When heavy charged particles hit a metal box, they create an electric current that can be measured.



On the next page are given 7 different physical effects that are utilized to measure radiation.

Ionization, scintillation, semiconductors and film are extensively used to observe individual particles. All of them can be used to determine radiation doses.

In addition to these effects we may also use biological changes, such as chromosome aberrations for dose determination.

For the sake of simplicity, it is important to have a response that is directly proportional to the dose, i.e., the dose-effect relationship should be linear. This is usually accomplished for physical effects, whereas biological changes such as chromosome aberrations seem to follow a linear-quadratic curve .

Detection methods and instruments

In this section we describe a number of different types of radiation measuring instruments. Consider the different physical events that can be utilized to make a measurement.

1. **Film.** Most people have seen an x-ray picture. The picture is the result of radiation hitting a photographic film. The more radiation exposure, the more blackening of the film. In radiation diagnostic, film has been the detection method. Furthermore, film-badges have been used by people working with radiation in hospitals or in research, keeping track of how much radiation exposure the workers have received. All x-ray pictures are now digitalized.
2. **TLD.** These initials stand for “*Thermo Luminescence Dosimetry*”. A crystal such as LiF containing Mn as an impurity is used. The impurity causes traps in the crystalline lattice where, following irradiation, electrons are held. When the crystal is warmed, the trapped electrons are released and light is emitted. The amount of light is related to the dose of radiation received by the crystal.
3. **Ionization.** Radiation results in the formation of positive and negative ions in a gas as well as in all other materials. Ionization can be used both for Bq measurements as well as for dose measurement. With knowledge about the energy needed to form an pair of ions – the dose can be obtained. The famous Geiger-Mueller tube, commonly called a Geiger counter, is designed to measure the electrical response produced by the newly formed ions.
4. **Scintillation.** A number of compounds have the property that they will emit light when exposed to radiation. The intensity of the emitted light depends on the radiation exposure and the light intensity is easily measured.
5. **Semiconductors.** Radiation produces an electric current in semiconductors that can be measured.
6. **Free radicals.** Radiation produces a class of chemical species known as free radicals. Free radicals by definition contain an unpaired electron and, although they are very reactive, they can be trapped in some solid materials. The number of trapped free radicals is a measure of the radiation dose.
7. **Redox products.** Radiation either reduces (by electron addition) or oxidizes (by electron abstraction) the absorbing molecules. Although these changes are initially in the form of unstable free radicals, chemical reactions occur which ultimately result in stable reduction and oxidation products.

In the following we shall see in more detail into the different detection methods and give a few examples which hopefully give you some information about detection techniques. In no other fields you can measure so tiny amounts as radioactivity – and may be this is the reason for the general fear among people for radiation. Let us start by giving an example.

How little radioactivity can be observed ?

Is it possible to measure 1 gram of I-131 if it is spread out over the entire world?

We have one gram of the radioactive isotope I-131. This isotope is a fission product (it is released in all the reactor accidents such as Chernobyl and Fukushima).

I-131 has a half-life of 8.04 days – it is a β -particle emitter and has a γ -photon with an energy 0.364 MeV. We use the γ -radiation with its particular energy for identification.

One gram I-131 is 1/131 mole of the compound. Since a mole contains $6.022 \cdot 10^{23}$ atoms (Avogadro's number) the number of I-131 atoms in 1 gram is $4.6 \cdot 10^{21}$.

The activity of 1 gram of I-131 (the number of atoms that disintegrate per second) is $4.59 \cdot 10^{15}$ Bq. This is found from the decay laws discussed in chapter 3 and the number is found by combining two of the equations discussed in chapter 3 (pages 36 and 37)

$$A = -\frac{dN}{dt} = \lambda N = \frac{\ln 2}{t_{1/2}} N = 4.59 \cdot 10^{15} \quad N = 4.6 \cdot 10^{21} \text{ atoms.}$$
$$t_{1/2} = 8.04 \text{ days} = 6.95 \cdot 10^5 \text{ seconds}$$

The area of the world – $4 \pi R^2$ – is approximately $5.1 \cdot 10^{14} \text{ m}^2$. For an even distribution of the I-131 gram it would be an initial activity of 10 Bq per m^2 . With good counters (like a germanium counter) **this activity can be observed and identified even in a mixture of other radioactive isotopes.**

You can measure 1 gram of I-131 even if it is distributed all over the world !



We can conclude that we have very sensitive equipment for measuring radioactivity. In the case of I-131 the activity in 1 gram is high because of the rather short half-life. The activity is closely connected to the half-life. For isotopes with longer half-lives, larger amounts are required.

For example Cs-137, with a half-life of 30 years and with 1 gram distributed all over the world, would have a specific activity of only 0.007 Bq per m^2 . This would not be detectable.

The total amount of Cs-137 released in the Chernobyl accident was according to UNSCEAR (1996) about 26.5 kg. If this amount was distributed evenly around the world the activity would be 185 Bq per m^2 . In some regions in Scandinavia the fallout reached 100 kBq per m^2 and near the reactor the activity was about 10 times larger.



On the following pages we give some more information about the different types of equipment used for measuring ionizing radiation – both counters and dosimeters. However, much more information can be found in textbooks and papers dealing with different types of measurements.

Film

We start this short review of detection methods with film – which has played an important role through the first hundred years of x-ray diagnostic. The first picture on film was presented already in 1895. Today film is on the way out of the hospitals since new digital methods have been introduced.

Ionizing radiation interacts with film pretty much like ordinary light. The sensitive compound consists of silver halides (mainly silver bromide mixed with small amounts of silver iodide). The radiation would split the molecules, leading to the formation of metallic silver particles. Since the silver particles are black, it implies that the radiation dose increases with the darkness of the film

A film used for x-ray diagnostic is built up by several layers like the base, the emulsion, and the protective coating. The detection layer is only about 10 μm thick and it is only the radiation that is absorbed in this layer that can give a picture. Consequently, in order to obtain a good picture it was necessary to increase the exposure and the dose.

The exposure time and consequently the radiation dose can be reduced by introducing so called "intensifying" screens – consisting of a layer of fluorescent crystals such as calcium tungsten and/or rare earth atoms. The point is that these screens absorb x-rays and yield light that in turn can expose the film.

The film has to be developed (which takes some time) and it represents a storage problem. Furthermore, very little can be done to the final picture. Since new digital techniques have been introduced x-ray film is already out of the hospitals.



It is difficult to analyze chest x-ray pictures since several organs are exposed. Lung pictures was important in the treatment of tuberculosis.

Dose determination by film

Workers who are potentially exposed to radiation often use film as a personal dosimeter (an example is given in the figure on the next page). It is worn on work clothes (sometimes on the lapel or belt).

The film is contained in a plastic holder that has small absorption plates of lead, tin, cadmium and plastic. In addition, there is an open window that makes it possible for weaker radiations to reach the film. The blackening behind the different plates depends on the energy and type of the radiation.

If the radiation contains neutrons of low energy, called thermal neutrons, the film behind the cadmium plate will show some extra blackening because of reactions between neutrons and cadmium – it is so called (n,γ) reactions.

This personal dosimeter is integrating – i.e. it adds up the radiation through a period like a week or a month. The blackening in all windows must be measured. The blackening of the film is linear to the dose, and doses up to about 10 Gy can be measured.

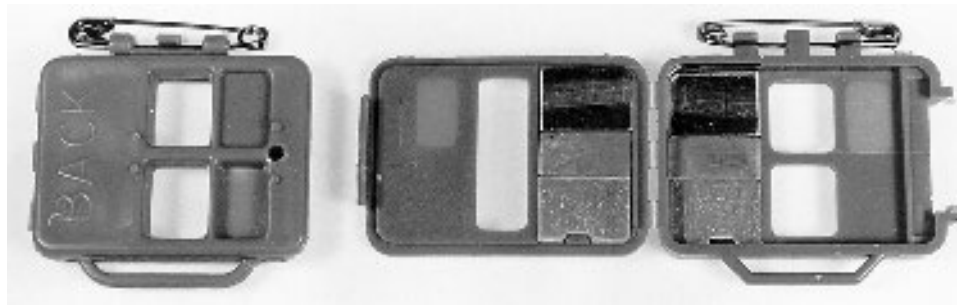

A picture of a film dosimeter. To the right, the plastic holder is opened to show the construction. In addition to an open window you can see several areas covered with absorption plates of different types.

Thermoluminescence-dosimeter (TLD)

This method is based on the fact that several crystals may trap imperfections like holes and electrons when irradiated. When such crystals subsequently are heated the trapped electrons receive enough energy to escape from the trap and fall to the ground state, emitting light photons. Since warming is a requirement, the technique is called thermoluminescence. ***The intensity of the luminescence is a measure of the dose.***

Small crystals of LiF (lithium fluoride) are the most common TLD dosimeters since they have the same absorption properties as soft tissue. The amount of light emitted at 200 °C due to the radiation is proportional to the dose in soft tissue.

TLD may be used as a personal dosimeter for β - and γ -radiation because it is independent of the energy of the radiation. Lithium has two stable isotopes, Li-6 (7.4 %) and Li-7 (92.6 %). Li-6 is also sensitive to neutrons. Consequently, if there is a combination of neutron and γ -radiation, the light emitted from a LiF crystal with Li-7 is a measure of the γ -radiation, whereas the light emitted using Li-6 yields the total dose from both neutrons and γ -radiation.

In the case of neutron detection, the efficiency of the detector depends on the energy of the neutrons. Because the interaction of neutrons with any element is highly dependent on energy, making a dosimeter independent of the energy of neutrons is very difficult.

Detectors Based on Ionization

An ionization chamber consists of a gas volume in an electric field between two electrodes. Radiation entering this volume results in the formation of ions. The positive ions will be attracted to the negative electrode, and negative ions will be attracted to the positive electrode. Ions with high enough energies may ionize even more molecules on their way to an electrode. This means that when the voltage across the electrodes increases, the number of ions increases. For a certain voltage (the proportional region), the number of ions at the electrode is proportional to the radiation energy deposited in the gas volume, resulting in a qualitative measure of the radiation energy.

If a very high voltage is used (called the Geiger-Mueller region), each ionization yields a cascade of ions that results in a pulse. Regardless of the energy of the radiation, the same size pulse is formed.

A large variety of detectors have been made where the basic physical event is the ionization. Both dose measurements as well as counting instruments have been made. We shall mention a few instruments based on the ionization process:

The proportional counter.

For this instrument the voltage across the electrodes is adjusted to let the number of ions that reach the electrodes be equal or proportional to the number of ions induced by the radiation. Thus, the pulse size reflects the energy deposited by the incident radiation in the detector gas. As such, it is possible to distinguish the larger pulses produced by alpha particles from the smaller pulses produced by betas or gamma rays. We have counters both with and without windows. The window less gas flow counters can be used to detect the very weak β -particles from tritium.

The gas used in the counters is usually a noble gas (mainly argon). For special purposes other mixtures of gases have been used, such as a tissue equivalent gas mixture consisting of 64.4% methane, 32.4% carbon dioxide and 3.2% nitrogen. For neutron detection He-3 and BF₃ (Boron Trifluoride) are the most commonly employed gases.

Geiger-Mueller counter.

This famous instrument is named after the two physicists who invented the counter in 1928. Mueller was a student of Hans Geiger.

The counter consists of a gas volume with two electrodes that have a high voltage between them. Very often the detector element is cylindrical in shape with the cylinder wall serving as the negatively charged (ground) electrode and a thin metal rod running along the middle axis serving as the positively charged electrode.



Hans Wilhelm Geiger
(1882 - 1945)

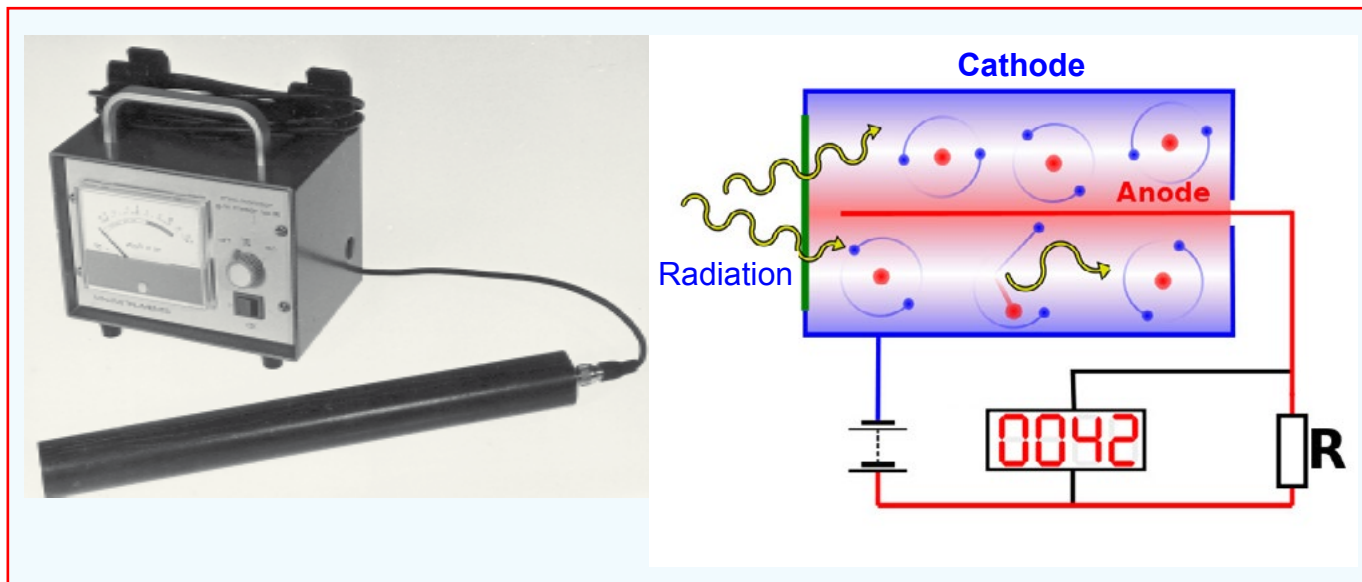

A Geiger-Mueller counter. To the left is a picture and to the right an illustration. The sensitive volume is a tube which is connected to a pulse counter. The counter yields information about the radiation intensity.

Ionizing radiation passing through the gas volume produces ions in the gas. The voltage is high enough for each electron attracted to the central electrode to make a cascade of new ions. This results in a pulse which is detected by a counter system and may also be sent to a speaker which produces an audible click.

The counter can be used as a warning instrument. It does not, however, yield information about the type of radiation or its energy.

The requirement that the radiation should reach the sensitive gas volume may be difficult for α -particles. The G-M counter is well suited to localize β - and γ -emitting radioactivity in connection with accidents.

The Scintillation Counter

The scintillation counter is based on the principle that light is emitted when a scintillator is exposed to radiation. Both solid and liquid scintillators can be found. Several organic compounds, such as benzene and anthracene, can be used. Crystals of sodium iodide (NaI) have been used in many experiments. The light pulse produced when radiation interacts with the scintillators is recorded by a photomultiplier tube.

Single crystals of NaI can be made with volumes of several liters. Hospitals all over the world have gamma-cameras which use NaI crystals in the form of large plates with diameters of more than 40 cm.

The light emitted when the crystal is irradiated is proportional to the γ -energy deposited. Consequently these counters are suited to measure the energy of γ -radiation and, therefore, can be used to identify γ -emitting isotopes.

Semiconductor Counters

Transistors and other components in electronic equipment are made of semiconducting materials. When electrons are released in these semiconductors, the current can be measured with great accuracy.

Solar cells are made of thin silicon crystals. They give rise to an electric current when hit by solar light. In a similar way a current can be induced by ionizing radiation. A large, clean and almost perfect semiconductor is ideal as a counter for radioactivity. The released electric charge is closely related to the radiation energy. ***These counters are employed to measure the energy of the radiation and for identification.*** The crystals are made of silicon or germanium. However, it is difficult to make large crystals with sufficient purity. The semiconductor counters have, therefore, low efficiency, but they do give a very precise measure of the energy. In order to achieve maximum efficiency the counters must operate at the very low temperatures of liquid nitrogen (-196°C).

The Energy of the Radiation – Isotope Identification

It is very important to have sufficient information about the energy of the radiation. ***With information about the energy and the type of particle observed, it is possible to identify a radioactive isotope.*** This may have great importance with regard to the storage and handling of radioactive sources.

Both semiconductor counters and scintillation counters produce pulses which are a measure of the radiation energy deposited in the sensitive volume. The number of pulses is a measure of the activity of the source. Before they are measured, the pulses are electronically amplified and filtered and grouped according to their size. They are then converted to numbers in an analog to digital converter (ADC). A computer sorts out the numbers and presents the results.

Example

In the figure on the next page is given the result for the Cs-137 isotope when observed with a sodium-iodide scintillation counter and a germanium semiconductor counter.

The radiation energy is given along the abscissa and the count number is given along the vertical axis. The curve attained is called a γ -spectrum.

Cs-137 emits both a β -particle (which is not observed in this case) and a γ -photon with an energy of 662 keV. The figure demonstrates how the two counters react when hit by the γ -photon.

The interpretation of the γ -spectrum is as follows: The γ -ray energy is absorbed either *completely* (the photoelectric effect) or *partly* in a Compton process. Consequently, the high energy peak in the spectrum, which has an energy of 662 keV, is called the "*photopeak*". The partly absorbed energy is seen in the left part of the spectrum – the *Compton part*.

It is the photopeak that is used for identification of the isotope. It is therefore important that the peak is narrow (good resolution).

Cs-137

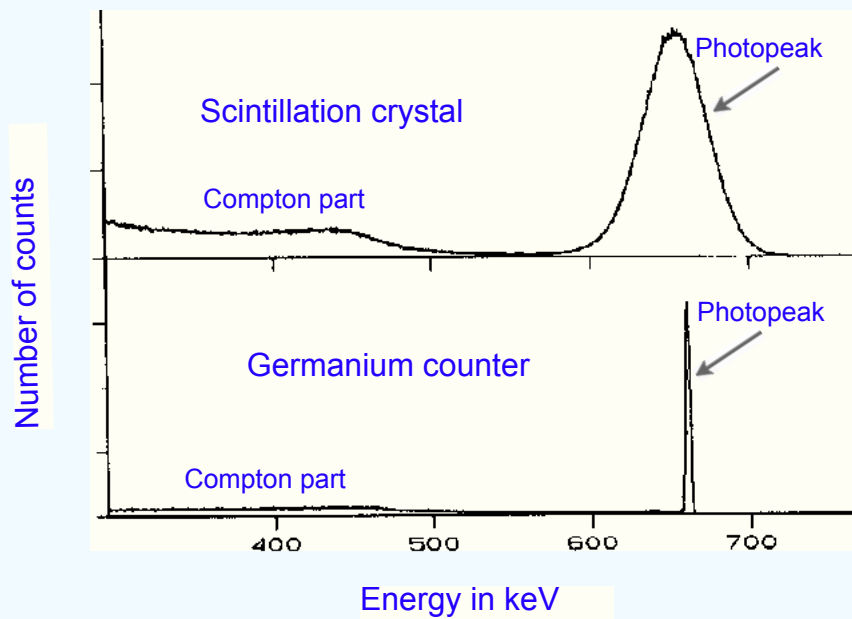

The γ -ray spectrum for Cs -137 measured with a sodium iodide scintillation crystal and a germanium semiconductor counter. The γ -radiation has a peak at 662 keV (the photopeak). This is important for identifying the different isotopes. (Courtesy of Finn Ingebretsen, Inst. of Physics, Univ. of Oslo)

The curve is usually called the response function of the counter. If a radioactive source emits several photons with different energies the spectrum will consist of several photopeaks.

The above two spectra demonstrate that a scintillation counter yields much broader lines compared to the germanium counter. Generally, it is easier to identify different isotopes with a counter that has good energy resolution, such as the germanium counter.

Several isotopes in a mixture

An example with several isotopes (some with more than one γ -photon) would yield a much more complicated spectrum. An example of this is given by the figure on the next page.

The fallout from the Chernobyl accident in April 1986 was observed several places around the world. Rather heavy fallout was observed in Scandinavia and in the figure (next page) is given an example. The sample (taken about two weeks after the accident) consisted of grass from the lawn outside the University of Oslo (about 2,000 km away).

The γ -spectrum shows that a number of isotopes were released. The isotopes that emit γ -radiation can be identified – and from the figure we can identify 7 isotopes.

See table next page.

A sample with isotopes from Chernobyl collected outside Blindern

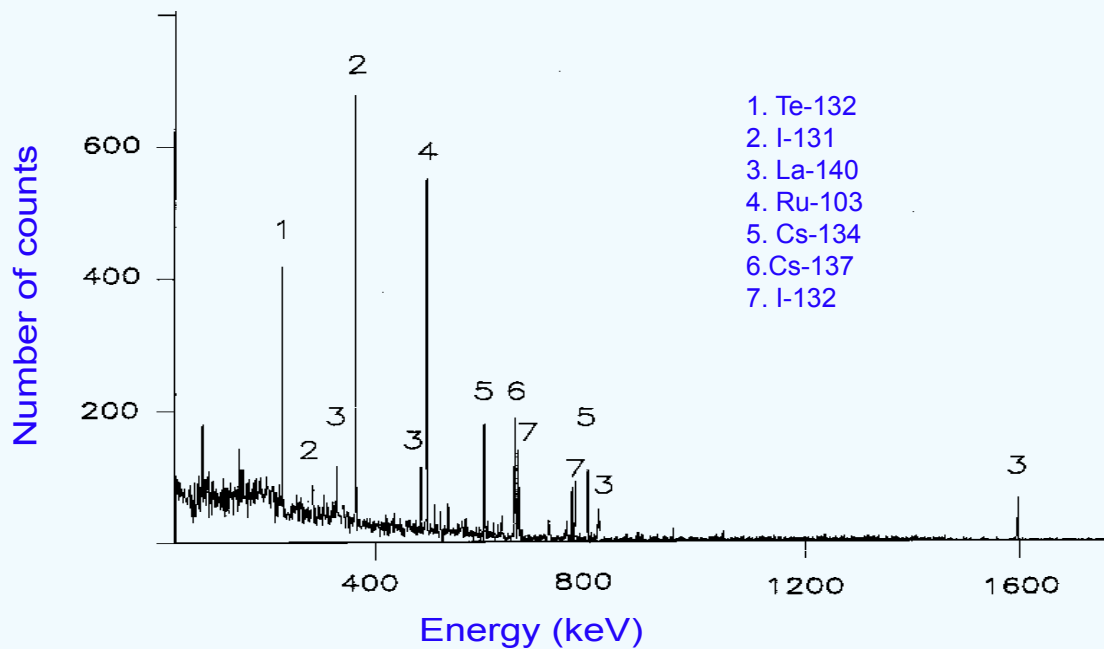

This is an example with an unknown mixture of isotopes. The sample, consisting of grass from the lawn outside the University of Oslo, exhibits the fallout from the Chernobyl accident.

The sample is taken about two weeks after the accident and contains therefore some of the short lived isotopes in addition to the Cs isotopes. A germanium counter was used and you can see a number of photopeaks which makes it possible to identify seven different isotopes. The inset and the table below give the 7 isotopes.

(Courtesy of Finn Ingebretsen, Inst. of Physics, Univ. of Oslo)

Number in figure	Isotope	Half-life	Energy of gamma photons
1	Te-132	77 hours	0.23 MeV
2	I-131	8.04 days	0.364 MeV
3	La-140	40.2 hours	0.33, 0.49, 0.82, 1.6 MeV
4	Ru-103	40 days	0.498 MeV
5	Cs-134	2.1 year	0.57, 0.60, 0.80 MeV
6	Cs-137	30 year	0.662 MeV
7	I-132	2.29 hours	0.673, 0.78 MeV

Chemical Separation can be used to identify isotopes that do not emit γ -radiation. Such methods made it possible to identify the isotopes present in the fallout from the nuclear tests in the 1960s. For example, it was found that the amount of Sr-90 (a pure β -emitter) was equal to the amount of Cs-137. Sr-90 is also in the fallout from the Chernobyl accident, but most of it was concentrated to the region around the reactor. Furthermore, Sr-90 can not be detected in experiments like that above.

Dose Measurements

The strength of a radioactive source (in Bq) and the energy of the emission (in eV) can be measured. This is, however, not a dose measurement.

The radiation dose is the energy deposited in the irradiated compound.

If the radiation hits a human being, the dose is defined as the energy deposited in the human body. The amount of energy deposited is almost always different from the amount of energy coming from the source. Deposited energy determines the dose.

Counters observe particles or photons sequentially. In dose measurements, the concern is not with the individual particles or photons but with the **total energy absorbed** in the exposed materials (e.g., tissue). It is difficult to observe energy absorption in tissue. Two of the problems are:

1. An exposure to one roentgen (1.0 R) of x- or γ -radiation can be measured with ionization chambers. This results in a radiation dose to soft tissue of approximately 9.3 mGy. The precision can be no better since the roentgen unit is based on the radiation absorption in air, whereas doses to a biological system (soft tissue or bone) are based on the energy absorbed in that system.

The absorption increases with the electron density of the exposed material and is therefore larger in bone compared with soft tissue. Furthermore, the energy absorption increases with decreasing radiation energy. Since these properties *are not* the same for air, soft tissue and bone, the doses delivered by a 1 R exposure are different.

2. When the radiation strikes a body, the dose changes with depth (i.e., the distance the radiation traverses in the body). One illustration is given in the figure below. Here different types of x-rays as well as a beam of charged particles (C-12 ions) are shown.

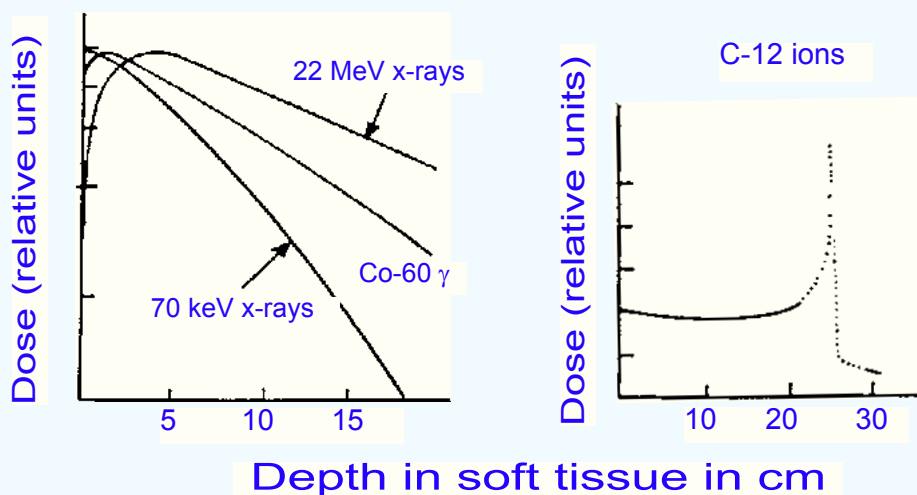

Depth dose curves for soft tissue. The dose is measured from the surface of the skin. On the left are data for x- and γ -rays as indicated. To the right is shown the dose curve for high energy charged particles. In this example carbon atoms, with all 6 orbital electrons stripped away, were used. The energy of the carbon ions when they hit the soft tissue is 5,688 MeV. The Bragg-peak strongly depends on the energy of the particle – otherwise similar curves are obtained.

3. In order to use radiation for cancer treatment it is important to have knowledge of the depth dose curves. As you can see from the figure above, the region for maximum dose can be changed by changing the x-ray energy. For tumors positioned deeper than 6 cm into the tissue, x-rays with an energy of more than 20 MeV should be used. The goal is to give a high killing dose to the tumor while minimizing the dose to the surrounding healthy tissue.

Charged particle radiation has a striking depth dose relationship (see page 27, 28). The dose peaks at the end of the track (called the Bragg peak). The Bragg peak occurs at a depth which depends on the energy of the particles. High energy protons, and more recently carbon-ions, have been used for cancer treatment. It requires large accelerators and it is, therefore, quite expensive. No such treatment is available in Norway today.

Fricke dosimetry

In experiments with chemical solutions the radiation dose can be determined by the chemical changes induced by the radiation. A well-known chemical reaction is based on the oxidation of Fe^{2+} to Fe^{3+} . It was the Danish chemist Hugo Fricke, who introduced this reaction for dosimetry in 1929.

We know that absorbed energy can convert Fe^{2+} ions to Fe^{3+} . The energy needed to convert one ion is 6.45 eV. The Fricke dosimeter consists of air-saturated 1 mM Fe^{2+} at pH 0.46. The conversion of Fe^{2+} to Fe^{3+} is measured by a spectrophotometer. The accepted yield – the number of ions formed per 100 eV absorbed, that is $G(\text{Fe}^{3+})$ is 15.5 for low LET radiations.

Some other aqueous systems utilized as radiation dosimeters include bromide ion, ceric sulfate, ferrocyanide, formic acid, ethanol, and ultrapure water.



Hugo Fricke
(1892 – 1972)

Free Radical Dosimetry

Among the highly reactive products formed in materials by radiation are free radicals. By definition, a free radical is a molecule that has an unpaired electron. Some examples are the hydroxyl radical (OH), the methyl radical (CH_3), and nitrous oxide (NO). Radicals are very unstable in aqueous systems such as in a living cell, but their lifetimes can be very long in solid materials. Consequently, trapped free radicals in solid materials can be used to obtain the radiation dose. The number of radicals formed and trapped is proportional to the radiation dose. The number of radicals is measured by the *Electron Spin Resonance* (ESR) technique.

This type of dosimetry started more or less by chance in 1982 connected to a fatal reactor accident in Norway. We shall therefore start by giving you some details about this accident and the dose determination.

A radiation accident

In September 1982 a fatal radiation accident occurred in a laboratory for radiation- induced sterilization of medical equipment in Norway. An employee was exposed to a large γ -dose. He was the only person at work when the accident happened. A coincidence of technical failures with a safety lock and an alarm light, together with neglect of the safety routines, resulted in the fact that he entered the room with the source in the exposure position. The drawing below shows the radiation facility. The source is Co-60 with an activity of 2430 TBq.

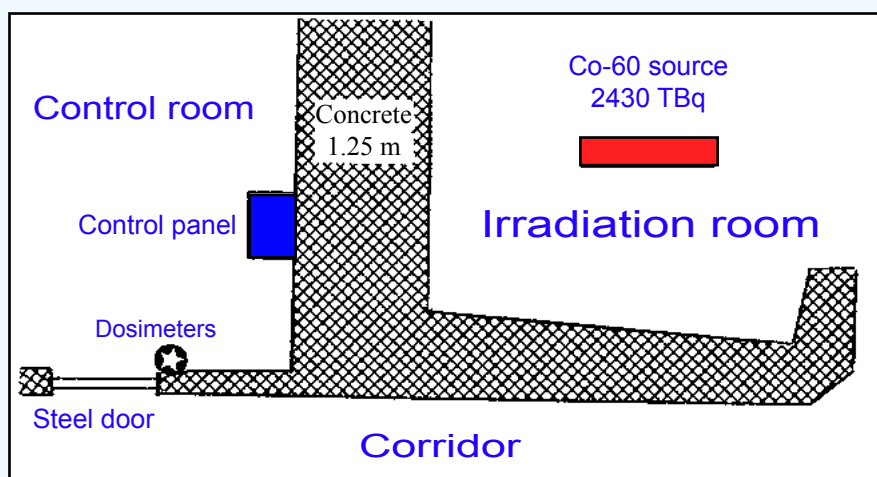

The employee was found outside the laboratory in the early morning with clear signs of illness. Since he had heart problems (angina pectoris), it was first assumed that he had a heart attack and he was hurried into the hospital. However, it became clear that he had been exposed to radiation. The man had *acute radiation syndrome* with damage to the blood forming tissue as shown in the figure below.

You can see from the figure that his blood counts went down dramatically – in particular the lymphocytes. The lymphocytes are of fundamental importance in the immune system. His temperature was about 38 degrees for a few days and then increased to about 40. He was all the time treated with antibiotics and several blood transfusions, but died 13 days after the accident.

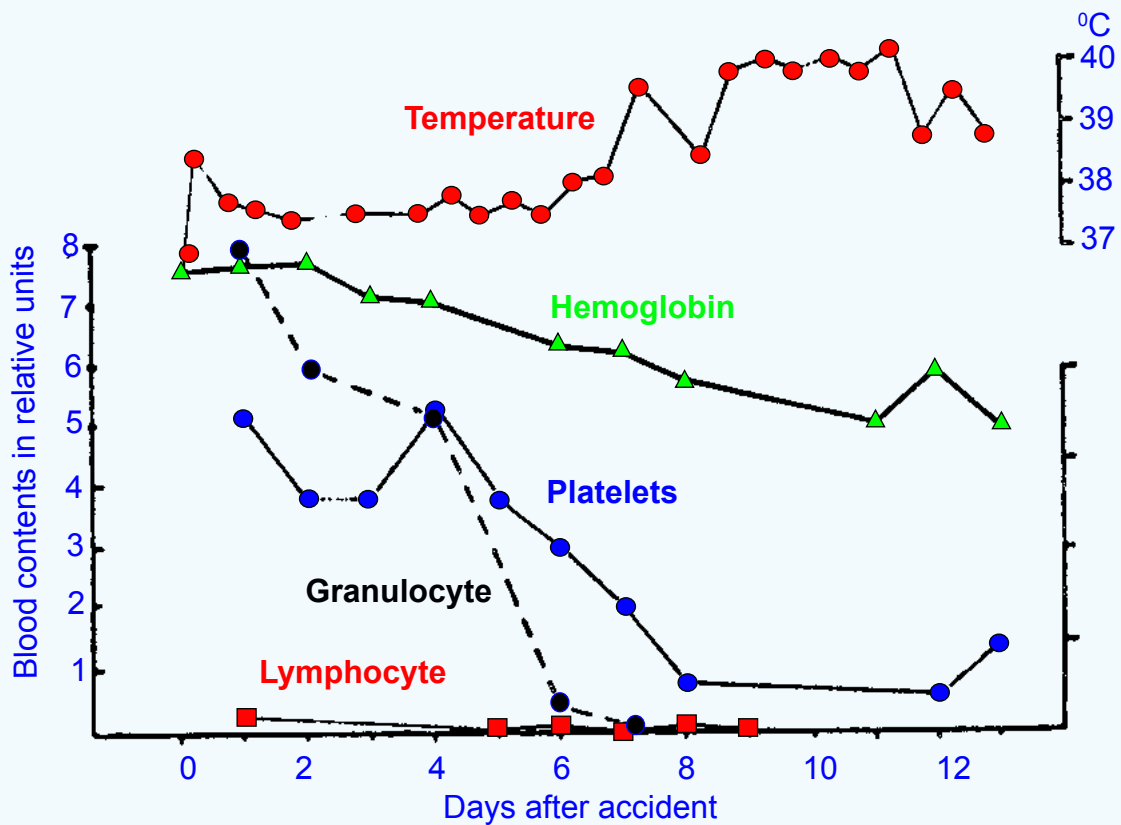

In the figure is given the body temperature (upper curve with temperature axis to the right) and the different blood values for the technician involved in the radiation accident in Norway. The lymphocytes were already knocked out after 24 hours. He was treated with antibiotics. It can be mentioned that in 1982 it was not possible to think on solutions such as bone marrow transplantation.

What was the radiation dose?

It is important to get information about the dose involved in this accident. We usually have very small opportunities to arrive at the dose in similar accidents. In this case the victim used a film badge as required for all employees. However, when developed, the film was black and could not give the dose involved.

Attempts were also made to interview the victim about the time spent in the irradiation room. The dose calculated from this was a couple of Gy and should be observed by the film badge. It was obvious the the dose must have been larger. What other possibilities were available?

The radiation authorities in Norway asked the ESR-group at the University of Oslo about the possibilities to use electron spin resonance to determine the dose. This turned out to be a challenging task and a hunt for objects containing radicals that were induced together with the victim. Induced radicals were found in the cloths (shoes and buttons) and in the nails of the victim. However, it was not possible to use these materials for a proper dose determination. The solution was found more or less by accident. The victim used nitroglycerol tablets because of heart problems. He always carried a small box containing these tablets – which turned out to solve the problem.

The nitroglycerol tablets consists mainly of sugar (lactose) which is the part in which the radicals are formed. The tablets from the accident was loaded with radicals. In order to use this system for a dose determination, it was necessary to work out a dose-effect curve (a calibration curve).

Tablets of the same type were irradiated with Co-60 γ -rays with doses from 1 to 80 Gy, as determined by thermoluminescence dosimetry. With a calibration curve in hand, the tablets irradiated with the victim could be determined as shown in the figure below.

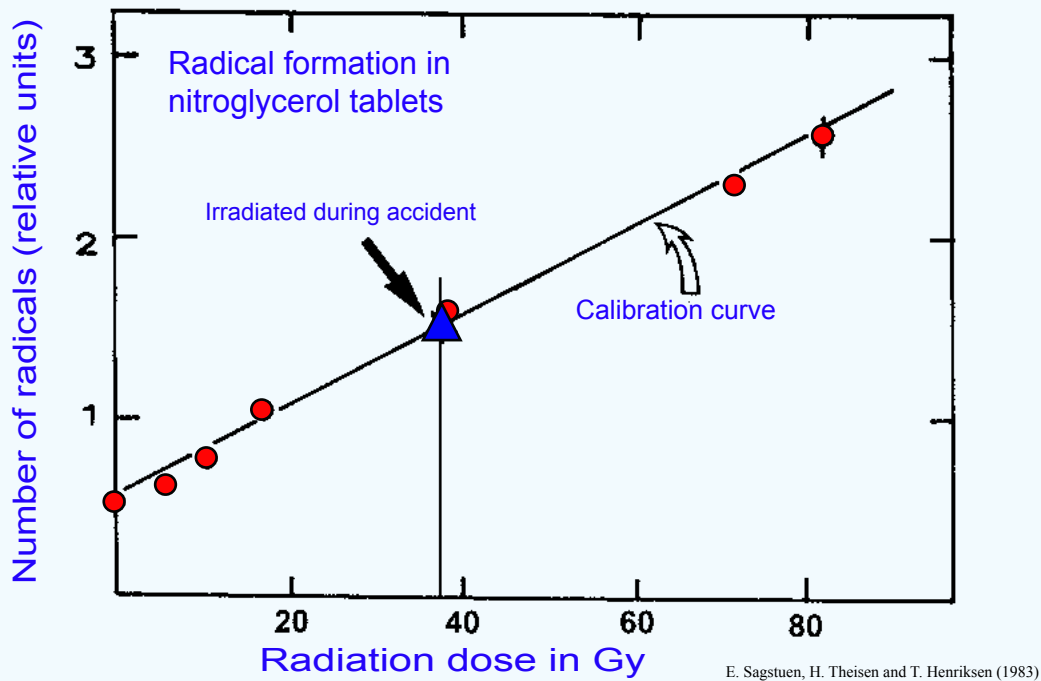

The accidental dose was determined to be 38.5 Gy. Then, measurements were made with a phantom which was placed in the exposure room at the same position as the victim. A number of TLD dosimeters were used and it was found that a dose of 38.5 Gy to the position of the box with the nitroglycerol tablets (in his pocket) yielded an average whole body dose of 22.5 Gy. The bone marrow dose was 21 Gy, whereas the dose to the brain was calculated to be 14 Gy.

Conclusion: ESR spectroscopy can be used for dose determinations, even after an accidental exposure.

Note: The accident occurred in 1982. The tablets have been stored since and used as a laboratory exercise for students in radiation biophysics every year. In the fall of 2008 (26 years after the accident) 4 different groups of students measured the dose again. The average value found was 38.5 Gy!

ESR - dosimetry

ESR (sometimes called EPR after Electron Paramagnetic Resonance) – dosimetry has developed during the last two decades. It was known already in the early 1960-ties that stable radicals were formed in crystalline organic compounds such as simple amino acids. The energy absorbed in order to form one radical was in the range from 5 to 50 eV, i.e. similar to the energy necessary to form an ion pair in a gas.

Crystalline organic compounds have qualities that is necessary for dosimetry such as:

1. Radicals are formed in high yields.
2. The radicals are stable for days, – even years.
3. The sensitive volume made of organic compounds can be made tissue-like.
4. The sensitive volume can be small – comparable to TLD dosimeters.
5. The dose-effect curves seem to be linear up to kGy-region.

The drawback during the 1960 – 1970-ties was that the ESR-spectrometers available could not be used unless the radical number exceeded a certain level – implying that the radiation dose had to be above a few Gy.

Another drawback that can be mentioned is that the radical yield decreases rapidly with LET for values above 10 keV/ μ .

For a long time the amino acid L- α -alanine in polycrystalline form has been used for ESR dosimetry. It has an atomic composition that makes it near tissue (and water) equivalent with respect to energy absorption. The radical yield is high (about 13 eV per radical), and the radicals produced are quite stable. The dose–response relationship is linear in the region between 2 Gy and 5–10 kGy. Alanine is very accurate when measuring high radiation doses (kGy), but it is not well suited for determining doses below a few Gy unless very cumbersome precautions and procedures are followed. As a consequence, alanine is not suited for clinical applications where doses down to 0.5 Gy should be easily detectable with high precision. This has motivated researchers to search for new sensitive ESR dosimeter materials that can do the job when alanine is inadequate.

Formates (salts of formic acid, HCOOH) were suggested as alternatives to alanine a few years ago by Anders Lund and coworkers in Linköping, Sweden. Ammonium and lithium formate both have properties similar to water with respect to absorption and scattering of radiation, and they show promising potential for accurate dose estimation at low radiation doses. Lithium formate has a sensitivity that is about 6 times as high as L- α -alanine, and it has the propensity to measure radiation doses down to at least 50 mGy. Under normal temperature and humidity conditions the radicals are stable for many months, and the dose–response shows almost no dependence on radiation qualities and energies at low LET. A dose–response curve for the 0–1.0 Gy region is displayed in figure on the next page.

Other materials that have been used for standard EPR dosimeters and for accident or retrospective EPR dosimetry include calcified tissues, various sugars, quartz in rocks, and sulfates.

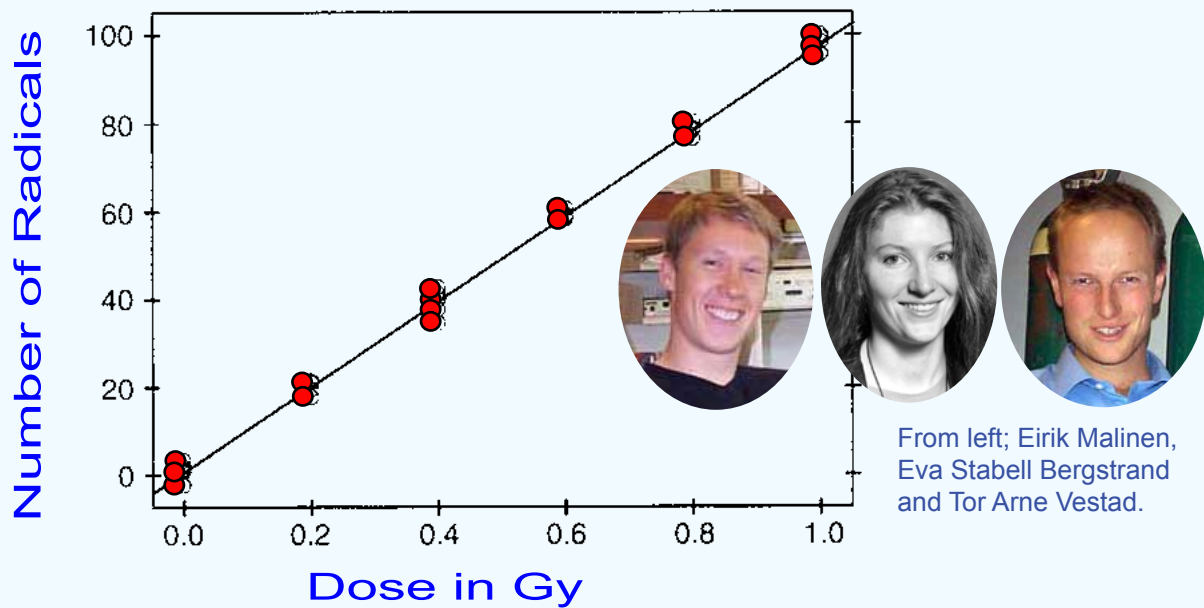

The figure gives the dose–response curve for lithium formate ESR dosimeter in the dose range 0 – 1.0 Gy. The results are from Ph. D. theses of students like Eirik Malinen, Eva Stabell Bergstrand and Tor Arne Vestad in the biophysics group at the University of Oslo.

Summing up

The "**dose rate**" is usually given when describing the intensity of the radiation being absorbed by the target, i.e. the radiation dose per unit time. The total dose is then obtained by a simple multiplication of the dose rate by exposed time.

In order to measure the dose to soft tissue exposed to γ -radiation, the walls of the instrument as well as the compound in the sensitive volume (whether a gas or a solid) must have a composition that has an absorption similar to soft tissue.

Thermoluminescence dosimeters (TLD) are frequently used for dose measurements. TLDs are well suited for different types of radiation as well as for large and small doses and dose rates. If LiF-crystals are used, x- and γ -rays yield a response which is proportional to the dose to soft tissue. If crystals with calcium are used, the response is proportional to the bone tissue dose.

Since the TLD crystals are small, they are well-suited for measurement of doses to patients. They can be placed on and in the body.

The recent development with ESR-dosimetry is promising. ESR-dosimeters can be given the same qualities as the TLD-dosimeters.

Chapter 7

The Natural Radiation Sources and doses to the people

1

Cosmic radiation

Myons, electrons and photons. In normal flying altitude the doselevel is about 40 times higher than that at ground level. The contribution from neutrons increases with altitude.

4

Radon

Rn-222 + "daughters"
Po-218
Pb-214
Bi-214
Po-214

The radon daughters give a dose to the bronchi and lungs

3

Radioactivity in the body

α, β, γ

K-40
C-14
Radium

2

External – γ Radioactivity from the ground

Uranium- and thorium-series and a few other isotopes, mainly K-40 and C-14.

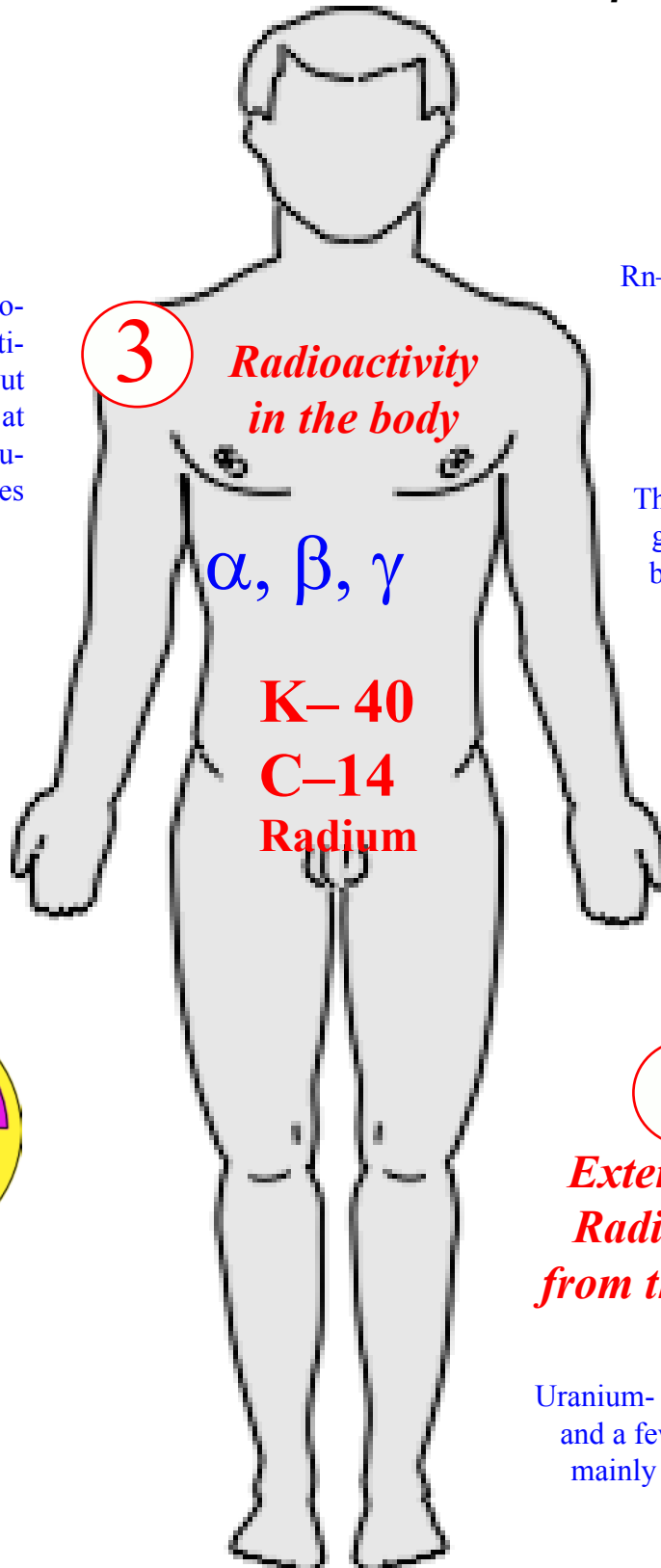
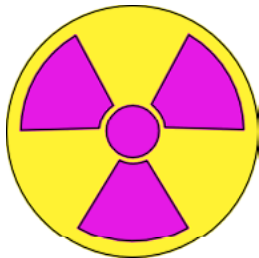

Introduction

There are radioactive isotopes in our bodies, houses, air, water and in the ground – and we are exposed to radiation from outer space. We divide all these radiation sources into four different groups:

1. Cosmic radiation.
2. External γ -radiation from natural radioactive sources.
3. Internal radioactive sources (radioactivity in the body).
4. Radon.

In this Chapter, we shall discuss the natural radiation in more detail. First of all, we shall give the physical aspects of the radiation sources and the level of radiation – both here in Norway and around the world.

UNSCEAR (United Nations Committee on the Effects of Atomic Radiation) has collected information about the distribution of the radiation sources around the world and doses to the public. We are largely using their data from the 2000 report.

<http://www.unscear.org/docs/reports/annexb.pdf>

We are exposed to natural radiation from cradle to grave – and the accumulated life-time dose, depends upon where you live as well as on your life style.

You can not go through life without radiation. It has been a silent rule that it would be good for you to keep your yearly dose to a minimum. However, new radiobiological experiments with cells and cell mechanisms seem to conclude that radiation in small amounts and with a low dose rate stimulate our defense mechanisms. The data suggests that radiation may protect you from cancer.

These very interesting data will be discussed later. Now we shall present the data for the environmental radiation. It can be mentioned that in the UNSCEAR report the doses are given in the Sv-system. However, it is very unclear what kind of RBE-values that are used for a mixture of neutron energies as found in the cosmic radiation.

For the four different groups above, the radiation consists of a mixture of γ -radiation, β -particles, neutrons (in the cosmic radiation) and α -particles (radon). This implies that for group 1. and 4. above, we have radiation with rather high LET. This suggests to use the Sv-doseunits. The unsolved question is however to use the right RBE value in the conversion from Gy to Sv.

In the case of cosmic radiation different neutron energies are involved. This would involve different RBE-values according to ICRP. No debate on this issue is known and we have decided to use the UNSCEAR values for this group. In the case of radon a RBE-value of 20 was introduced and used. However, dose determinations turned out to be impossible to handle and all correlations between radon and lung cancer is now based, not on radiation dose, but rather on the Bq/m³ in the home where you live or on the workplace in the case of miners.

Cosmic Radiation

Victor F. Hess discovered the cosmic rays in 1912. In a series of balloon experiments with ionization chambers he found a noticeably increase from 1,000 m onwards, and at 5 km height the ionization level was several times that observed at sea level. He concluded that this ionization was due to radiation from the atmosphere. This radiation is called; *Cosmic radiation*.

The fact that the radiation level increases with height is clearly demonstrated in the figure below. Some of our colleagues at The University of Oslo carried a radiation detector on a flight from Trondheim to Oslo. A considerable fraction of the high energy radiation will penetrate airplanes, giving passengers and crew an extra dose during air travel. In this air travel, that lasted for 40 minutes, the plane was cruising at an altitude of 8500 meters (27,900 feet).

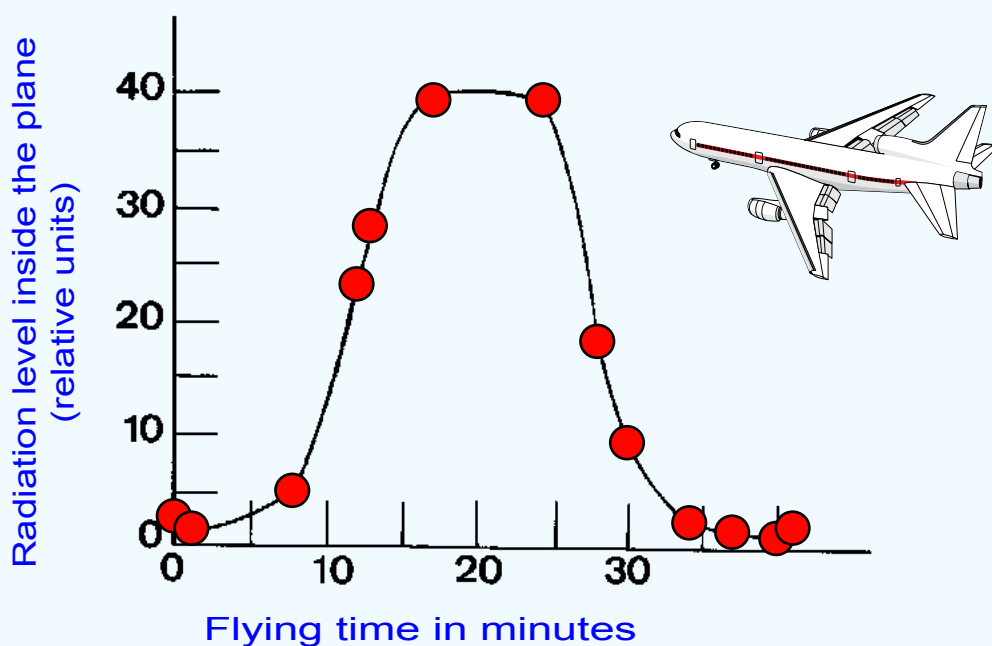

Before start, when the plane was on the ground, the radiation level is set equal to 1. This value represents the sum of cosmic radiation from above and γ -radiation emanating from natural sources at ground level.

You can see that when the plane reached the altitude of 8,500 meters (27,900 ft), the radiation level is approximately 40 times that observed at ground level.

From the figure you can see that the radiation level was slightly smaller just after take-off and just before landing. The reason for this is that, in both occasions, the plane was above water, which contains very low levels of γ -emitters.

It can be mentioned that the cosmic radiation was studied by a number of students in Norway in the 1940-ties, supervised by professor Bjørn Trumphy. They made their own Geiger tubes and used several tubes at the same time in a row. Coincidence measurements could give information about directions, and shielding gave information about penetration. The radiation had a *hard* and a *soft* component.



Bjørn Trumphy
(1900 – 1974)

The nature of the cosmic radiation

The atmosphere is continuously exposed to particles from outer space, about 98 % nucleonic and 2 % electrons. The nucleonic component is primarily protons (88%) and alpha particles (11%), whereas the remainder is heavier nuclei.

The energy of the primary cosmic radiation is from 10^8 to more than 10^{20} eV (the highest value observed in cascades is $3.2 \cdot 10^{20}$ eV). In this connection it can be mentioned that with the Large Hadron Collider in Geneva the scientists will accelerate protons to an energy of $7 \cdot 10^{12}$ eV.

The amount of particles vary with the energy. Thus, for energies up to 10^{15} eV the variation is as $E^{-2.7}$ (E being the energy), and above this level it is as E^{-3} .

The origin of the high energy particles is from outer space. It is assumed that particles with an energy up to about 10^{15} eV are coming from our own galaxy, whereas those with the highest energies probably have an extragalactic origin.

Solar wind contribution

A small component of the cosmic rays is generated near the surface of the sun by magnetic disturbances. These solar particle events (solar flares) are comprised mostly of protons of energies below 100 MeV and only rarely above 10 GeV (10^{10} eV). These particles can produce significant dose rates at high altitudes, but only the most energetic ones affect the dose rates at ground level.

Solar flares are of short duration, typically a few hours, and highly variable in intensity. They have a negligible impact on long-term doses to the general population. Solar particle events can, in addition, disturb the earth's magnetic field in such a way as to change the galactic particle intensity. See the illustration below.

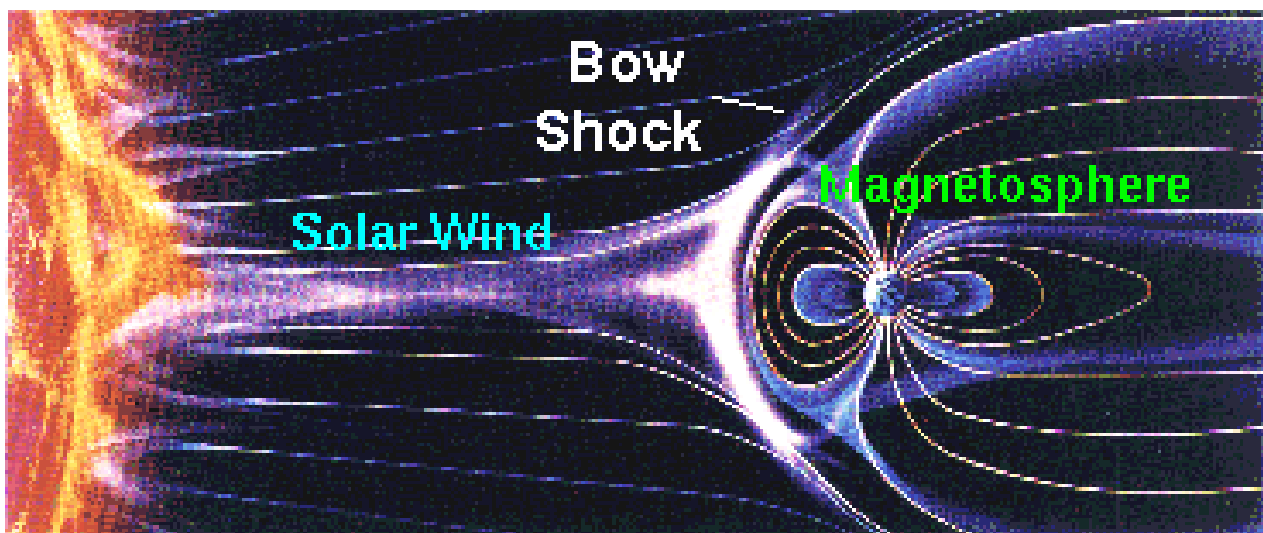

An illustration of the solar wind and the magnetic field of the earth. The high energy particles coming into the atmosphere, will interact with the atmospheric atoms and molecules (mainly nitrogen and oxygen). A number of nuclear reaction will take place, and particles will be formed – both charged particles and neutrons. Some of the radiation may reach ground level, yielding a yearly dose of approximately 0.4 mGy. Furthermore, the particles will lead to excitations which again give us both "aurora borealis" and "aurora australis". Finally the combination of the Earths magnetic field and the charged particles (mainly protons and electrons) give the Van Allen belts.

Another point that should be taken into consideration is the 11-year solar cycle. The periodic variation in solar activity produces a similar variation in the solar wind. The solar wind is a highly ionized plasma with associated magnetic field. The magnetic field of the earth partly reduces the intensity of cosmic radiation reaching the top of the atmosphere. Thus, at times with maximum solar activity the magnetic field is at its highest and the galactic cosmic radiation intensity is at its lowest. Furthermore, the magnetic field produces a geomagnetic latitude effect, with minimum intensities and dose rates at the equator and maximum near the geomagnetic poles.

Cosmic radiation hit the atmosphere

The high-energy particles hitting the atmosphere interact with atoms and molecules in the air. This results in a complex set of secondary charged as well as uncharged particles, including protons, neutrons, pions and some other particles. These secondary nucleons in turn generate more particles, and we get a cascade in the atmosphere. Thus, cosmic rays seem to represent a theatre or a laboratory for high energy physics. Several elementary particles were discovered in experiments with cosmic radiation (see next page).

Neutrons, which have a long free pathway, dominate the particle component at lower altitudes. The neutron energy distribution peaks between 50 and 500 MeV and with a lower energy peak, around 1 MeV.

The pions generated in the nuclear interactions are an important component of the cosmic radiation field in the atmosphere. The neutral pions decay into high-energy photons, which produce high-energy electrons, which in turn produce photons etc., thus producing the electromagnetic, or photon/electron, cascade. Electrons and positrons dominate the charged particle fluency rate at middle altitudes.

The charged pions decay into muons, whose long mean free path in the atmosphere makes them the dominant component of the charged-particle flux at ground level. They are also accompanied by a small flux of collision electrons generated along their path.

As you can see, we have a complex picture of radiation from ground level and up to the top of the atmosphere. In recent years the radiation intensity in the atmosphere has been measured – and we can give some details about doses at ground level – and also present information about doses at aircraft altitudes. Finally we shall discuss the Van Allen belts, even if they influence only space travellers.

The figure is given by UNSCEAR and is an attempt to give the relative contribution to the dose by the different types of radiation. Consequently, at all altitudes the sum is 100 %.

At sea level myons and electrons/photons are the most important. At aircraft altitudes (8000 – 11000 m) neutrons are very important (about 40 %).

It is obvious that it is very difficult (impossible) to apply a radiation weight factor to the neutron radiation since it is a mixture of neutron energies involved.

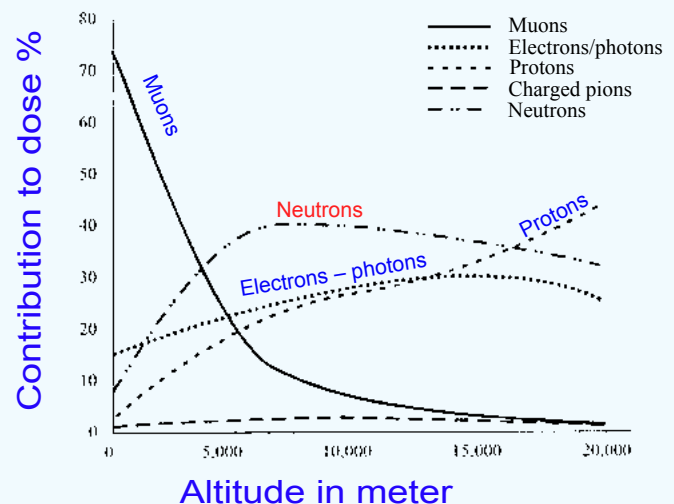

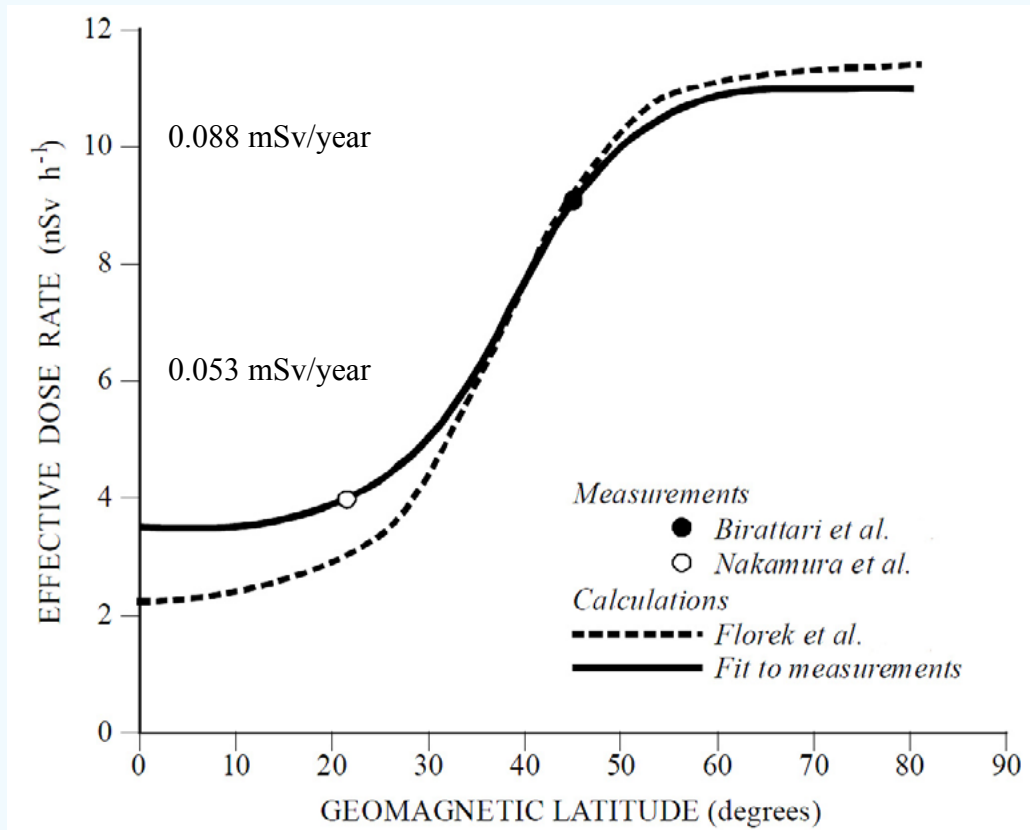

This figure is given by UNSCEAR and the dose is given in nSv per hour. You see that the dose around equator is about 0.03 mSv per year. For latitudes such as Oslo the contribution is about 0.09 mSv per year. Note also the discussion on RBE for neutrons.

Cosmic rays – a laboratory for high energy physics

The cosmic rays were discovered in 1912 by Victor F. Hess. He received the Nobel prize in physics in 1936 for this discovery.

Before we developed the high energy accelerators, cosmic radiation was the source for high energy physics. Several particles were for the first time observed in experiments with cosmic radiation, such as the positron and the muon. The positron was proposed by P.A.M Dirac in 1928 and discovered by Carl D. Anderson in 1932.

Here we just summarize some of the particles found in the cosmic rays.



Victor F. Hess
(1883 – 1964)

Pion (or pi meson) is any of the three particle denoted π^0 , π^- and π^+ .
The particles have a mass of about 270 electron masses, and have an extremely short life-time. Pions decay in the following way:

The negative pion decays into a negative muon and a neutrino. $\pi^- \rightarrow \mu^- + \nu$
The positive pion decays into a positive muon and a neutrino. $\pi^+ \rightarrow \mu^+ + \nu$
The neutral pion decays into two photons. $\pi^0 \rightarrow 2 \gamma$

The muon (mass about 206 electron masses) was discovered by Carl Anderson in 1936 in the cosmic radiation. He called the particle for mesotron. This is the main product from the cosmic radiation reaching the sea level (see figure on opposite page).
Muons have been given (ICRP) a radiation weight factor of 1 and pions a factor 2.

Hideki Yukawa suggested in 1935 the existence of the meson and the charged pions were observed in the Cosmic radiation in 1947 by Cecil Powell using photographic emulsions placed on the top of mountains in the Pyrenees and later in the Andes.



Carl David Anderson
(1905 – 1991)

Nobel prize in 1936 together with Victor Hess.



Hideki Ykawa
(1907 – 1981)

Nobel prize in 1949.



Cecil Frank Powell
(1903 – 1969)

Nobel prize in 1950.

Doses at ground level

At ground level the muons, with energies mostly between 1 and 20 GeV, contribute about 75 % of the absorbed dose rate in free air. The remainder comes from electrons produced by the muons or present in the electromagnetic cascade. Furthermore, we have to include a dose from the neutrons (see figure on page 87).

In the early literature, the two components of the charged particle flux (muons and electrons) were referred to as the “hard” and “soft” components, respectively, because the electrons are much more readily absorbed by any shielding.

From some recent experiments, UNSCEAR assume the dose rate at sea level from muons and electrons to be 32 nGy h⁻¹. This indicate a total yearly dose of 0.28 mGy. The geomagnetic latitude effect is about 10%. (Since in this case the radiation weighting factor is by ICRP set to 1, the equivalent dose is also 0.28 mSv.)

We also have to include the neutrons at ground level. This is however, much more difficult. Some data are available about the neutron fluency and energy distributions, but from recent measurements some information is available. According to UNSCEAR the fluency is 0.0123 cm⁻² s⁻¹ at sea level for a geomagnetic latitude of 45 N. Based on this, the effective annual dose from neutrons at sea level and at 50 degree latitude is estimated to be 0.08 mSv (see figure on page 88). For neutron radiation it is a stronger variation with latitude because the protons which yields the neutrons, are strongly affected by the earth’s magnetic field. The latitude variation for the neutron contribution is from 0.05 – 0.11 mSv per year.

With the above considerations we have established a dose level from the cosmic radiation at sea level. However the majority of people live at slightly higher altitudes where the radiation dose is larger. Furthermore, people spend a large fraction of time indoors, where the buildings attenuate the soft part of the cosmic rays.

An analysis has been made to combine the altitude dependence of dose with the altitude distribution of the worlds population. For the directly ionizing and photon component the population-weighted average dose rate is 1.25 times that at sea level, and for neutrons 2.5 times.

We have tried to outline some of the problems in order to arrive at an average public dose due to cosmic rays. We have some knowledge about the energy distribution of the neutrons – but it is still a guesswork to find the correct radiation factor to use. In order to end this discussion we give the values suggested by UNSCEAR for the population-weighted average in the table below.

Annual dose = 0.38 mSv

Conditions	Effective dose rate ($\mu\text{Sv a}^{-1}$)						
	Directly ionizing component			Neutron component			Total
	North	South	World	North	South	World	World
Outdoors, at sea level	272	265	270	49	35	48	320
Outdoors, altitude adjusted ^a	339	332	340	124	87	120	460
Altitude, shielding, occupancy adjusted ^b	285	279	280	104	73	100	380

^a Altitude-weighting factors applied to sea level values: directly ionizing component 1.25; neutron component 2.5.
^b Building shielding factor 0.8; indoor occupancy factor 0.8.

Air travel

The variation in cosmic radiation with the height above sea level can easily be observed when flying. This means that passengers as well as air crews receive an extra dose when flying. The majority of the world's population do not fly, but air crew members have an average of 500 hours per year in the air. Based on the types of radiation at flying altitudes (8000 – 12000 meter) some guidelines have been worked out.

For altitudes of 9 – 12 km at latitudes about 50°, the effective dose rate is in the range 5 – 8 μSv per hour. For a transatlantic flight from Europe to North America, the dose would be 30 – 45 μSv (0.03 – 0.045 mSv). At equatorial latitudes, the dose rates are lower and in the range of 2 – 4 μSv per hour.

For an altitude of 18 km the effective dose rates would be 10 – 12 μSv per hour. These data can give us some guidelines with regard to extra effective doses from cosmic radiation due to air travel.

We keep in mind the discussion about RBE and the conversion of dose from Gy to Sv – and give here the values used by the radiation authorities.

Exstra dose event	Dose in mSv
Pilot – annual dose	3 – 4
Oslo – Tromsø	0.01
Oslo – Hellas	0.025
Oslo – San Francisco	0.1

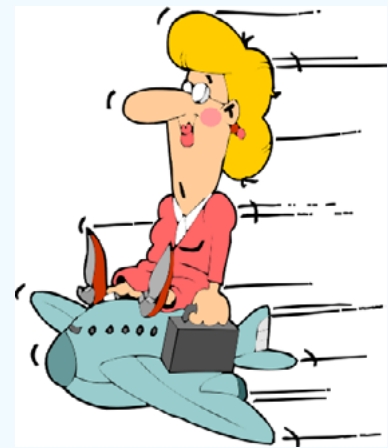

Other results and effects of the cosmic radiation

We have to mention two other effects of the cosmic radiation, namely the beautiful northern and southern lights (*aurora borealis* and *aurora australis*), and the Van Allen radiation belts far out in space.

Northern light

Due to the special form of the earth's magnetic field the cosmic particles penetrate to much lower altitudes in the polar regions. This makes Norway quite particular with regard to observation of Northern light.

Northern light is formed when charged particles from the cosmic radiation enter the earth's magnetic field. The magnetic field guides the particles to the regions around the earth's magnetic poles. High up in the atmosphere (above 90 km), the particles are

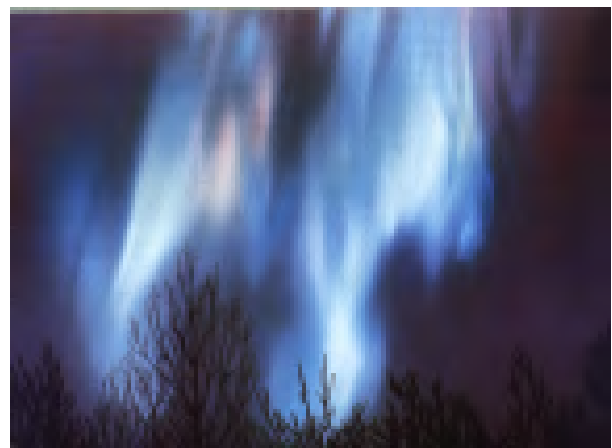

stopped by the gases in the atmosphere. Part of the particle energy is used for excitations of the atoms and molecules in the air (nitrogen and oxygen) – which result in specific light upon de-excitations. The colors of the aurora are determined by the gases present. When the solar activity is high, strong northern and southern lights can be observed.

Norwegian scientists, Kristian Birkeland and Carl Størmer are well known for their work with the Northern light. Their work is remarkable since it took place in a time before Hess had made his observation of the cosmic radiation. Birkeland's Terrella experiment, which in an elegant way explained the Northern light was carried out in the period **1900 – 1908 !**

Carl Størmer measured the height of the Northern light (90 – 125 km altitude). Furthermore, he was a brilliant mathematician – and he calculated the orbitals of the electric particles in the earth's magnetic field. As a result of these calculations the radiations belts – Van Allen belts – can be suggested.



Kristian Birkeland
(1867 – 1917)



Carl Størmer
(1874 – 1957)

Van Allen radiation belts

In January 1958 the first American satellite, Explorer 1, was launched from Cape Kennedy center in Florida. James Van Allen, the instrument chief, had placed a Geiger counter on board. The goal was to measure the intensity of cosmic rays, fast ions that come from space, and in particular its variation with the distance from the magnetic equator. The hope was to observe particles that could not penetrate the full thickness of the atmosphere and reach the ground.

The data were puzzling – thus at low altitudes the number of counts was normal, then it rose rapidly.

At an altitude of 2000 km the counter could not follow. The counter discharged so frequently that it could not recover between the counts, with the result that the counting stopped. The radiation belt was discovered. The Van Allen belt is formed like a torus or doughnut above the equator at an altitude of about 6000 kilometers. It contains energetic protons in the 10-100 MeV range and

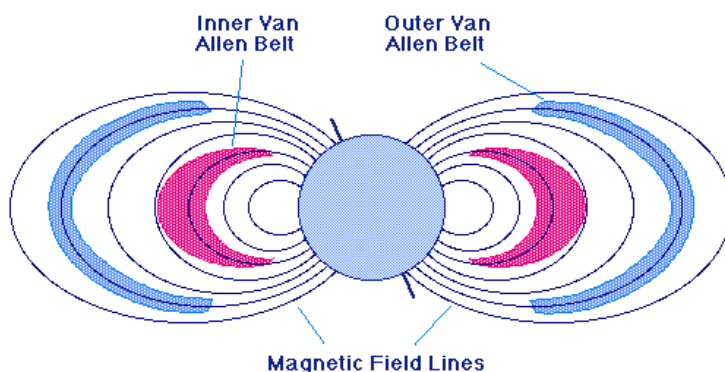



James Van Allen
(1914 – 2006)

is a result of the cosmic radiation. The particles can readily penetrate spacecrafts and prolonged exposure can damage instruments and be a hazard to the astronauts.

In experiments with Pioneer 3 and 4 an outer radiation belt was discovered. It is part of the plasma trapped in the magnetosphere. The outer radiation belt extends from an altitude of about three to ten Earth radii (ER), and its greatest intensity is usually around 4-5 ER. The trapped particle population of the outer belt is varied, containing electrons and various ions.

A lot of research is still going on in order to attain more information about these particular radiation belts.

If you are interested in the possibilities to observe Northern light the periods with high solar activity is important. The daily variation in the solar activity can be followed.

See the address: <http://www.solarcycle24.com/>

2. External Gamma-radiation from natural sources

Gamma-radiation, emitted by radioactive isotopes in building materials and the ground, produces an annual dose of about 0.5 mGy – or 0.5 mSv. In certain areas the γ -radiation can be much larger, particularly in areas where the ground contains thorium and radium. Let us consider, in more detail, the sources of γ -radiation.

Natural Radioactive Sources

A long time ago, when the earth was created, a number of radioactive elements were formed. Some of these isotopes have very long half-lives, billions of years, and are still present. Since radioactive isotopes are unstable, a disintegration eventually occurs, resulting in a different type of atom. This continues until a stable (non-radioactive isotope) is formed.

Because most of the natural radioactive isotopes are heavy (found in the fifth row or higher in the periodic table), more than one disintegration is necessary before a stable atom is reached. This radioactive series is called a *radioactive family*. It is not unusual for the number of disintegrations comprising a series to be around 11 to 14 different nuclides. The two most important radioactive series today are the *Uranium-radium-series* and the *Thorium-series*. There are two other series, but they have almost disappeared from the Earth because they have much shorter half-lives. The four possible series are given in the table on the next page.

The radioactive series



Name	Start	End	Half-life in year
Uranium – radium	U - 238	Pb - 206	$4.47 \cdot 10^9$
Neptunium	Np - 237	Bi - 209	$2.14 \cdot 10^6$
Uranium – actinium	U - 235	Pb - 207	$7.038 \cdot 10^8$
Thorium	Th - 232	Pb - 208	$1.405 \cdot 10^{10}$

The first radioisotope in the Thorium-series has a half-life of $1.4 \cdot 10^{10}$ years. This is why there is still a lot of thorium in the ground. On the other hand, neptunium with its short half-life has disappeared. However, it can be produced in the laboratory. Thus, all four radioactive series are well understood. The starting element in the Uranium-actinium series has a half-life of $7.038 \cdot 10^8$ years. This is short compared to the age of the earth (5 billion years or about 7 half-lives), and therefore the content of U-235 is only 0.71 % of the Uranium isotopes.

In addition to these radioactive series, there are a number of other radioactive isotopes. The most important is K-40 with a half-life of 1.27 billion years. This half-life is shorter than the age of the earth and only a few percent of the original K-40 remains today. The half-lives given in the table indicate that the natural radioactivity has decreased considerably since the formation of the earth. This is of interest when speculating about the origin of life and discussing the possible effects of radiation when the Earth was younger. We can conclude that early life existed with a much higher level of natural radiation.

Distribution of Natural Radioactivity

Natural radioactivity varies from place to place. With regard to doses from external γ -radiation, the most significant contributions come from the elements in the uranium-radium-series, the thorium-series and K-40.



Anders Storruste
(1917 – 2001)

In order to give a quantitative measure for the presence of radioactive elements, the number of becquerel per kilogram (Bq/kg) can be obtained for different types of rock and soil. Of course, this varies from place to place. In the table next page are presented some data from measurements carried out at the University of Oslo under supervision of Anders Storruste.

Storruste also developed the TLD - method for determination of the radon content in the air in buildings. He was responsible for the first mapping of the radon level in Norwegian dwellings.

The concentration of isotopes (given in Bq/kg)

in some species of rock and soil.



Species of rock/soil	Ra – 226	Th – 232	K – 40
Granite	20 – 200	20 – 80	600 – 1800
Thorium and uranium rich granite	100 – 500	40 – 350	1200 – 1800
Gneiss	20 – 120	20 – 80	600 – 1800
Sandstone	5 – 60	4 – 40	300 – 1500
Limestone	5 – 20	1 – 10	30 – 150
Slate	10 – 120	8 – 60	600 – 1800
Shale (from cambrium)	120 – 600	8 – 40	1000 – 1800
Shale (lower ordovicium)	600 – 4500	8 – 40	1000 – 1800
Shale rich soil	100 – 1000	20 – 80	600 – 1000
Moraine soil	20 – 80	20 – 80	900 – 1300
Clay	20 – 120	25 – 80	600 – 1300
Sand and salt	5 – 25	4 – 30	600 – 1200
Average (Norway)	50	45	850

The table above gives the concentrations of Ra-226, Th-232 and K-40 in different species of rock found in Scandinavia. It appears that certain types of shale exhibit concentrations of Ra-226 up to 4,500 Bq/kg. The concentration of Th-232 also varies considerably from one mineral to another. In certain areas of the world, such as India, Brazil and Iran, the thorium concentration in the soil can be 10 to 100 times above the average (see below).

Potassium is everywhere. It is in soil, plants, animals and humans. The element potassium makes up 2.4 percent by weight of all elements. However, the abundance of the radioactive isotope K-40 is only 0.0118%.

It can be noted that the variation of K-40 between different types of rock is much smaller than that for radium and thorium. K-40 emits both a β -particle and a γ -ray (see the decay scheme on page 26).

Each isotope contributes a different amount to the total external γ -dose: approximately 40 % from K-40, 40 % from Th-232 and about 20 % from Ra-226.

Outdoors

Direct measurements of absorbed dose rates in air have been carried out in the last few decades in many countries of the world. According to UNSCEAR the population-weighted average doserate is 59 nGy h^{-1} . *This yields an annual exposure dose of 0.52 mGy.*

The lowest average values are found in Cyprus, Iceland, Egypt, the Netherlands, Brunei, and the United Kingdom and the highest values are in Australia, Malaysia, and Portugal. The average value for Norway is 0.63 mGy per year.

We shall mention some places with very high values with external γ -radiation.



Places with high external gamma-radiation

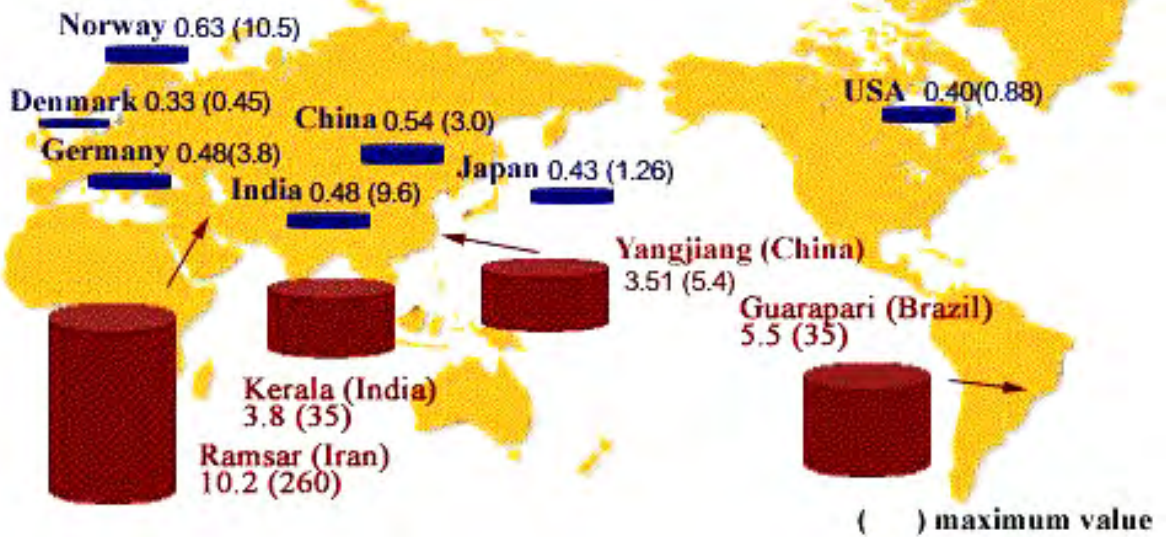

The above figure is adapted from Health Research Foundation, Kyoto, Japan. Four areas with very high background radiation is outlined. The values are given in mGy/year with maximum values in parenthesis.

It can also be mentioned that several places in Italy with volcanic soil the outdoor dose level is about 1.7 mGy per year. Lets us show some of the places with high background radiation (HBR).

Guarapari Brasil

The city is 375 km north of Rio and have about 100 000 inhabitants. The beaches are full of radioactivity from the thorium-series.

On the beach you can get a whole body dose of 10 mGy in a week.

In the picture to the right you see a couple on the beach with a Geiger counter.



The whole region along the coast with monazite sand, has a high dose level. A large amount of dose measurements have been carried out. However, no personal doses can be given – and no special cohorts have been studied with regard to health effects.

Kerela India



The coastal belt of Karunagappally, Kerala in India, is a well known high background radiation (HBR) area. Again it is the monazite sand with the thorium series. For a large area the median outdoor radiation level is more than 4 mGy/year. In certain locations on the coast, it is as high as 70 mGy/year.

A study of the cancer incidence in the area has been performed. A cohort of 173 067 residents have been followed for 15 years, both with regard to dose as well as cancer incidence. No excess cancer risk due to exposure from the gamma-radiation was found. According to the LNT-hypothesis a significant increase should be expected.

Ramsar Iran



In Ramsar we find the highest level of background radiation, measured to up to 260 mGy/year. The areas of highest background are found in discrete locations, corresponding to specific geologic features.

The radioactivity in Ramsar is due to Ra-226 and its decay products, which have been brought to the surface by the waters of hot springs.

There are more than 9 hot springs with different concentrations of radium in Ramsar that are used as spas by both tourists and residents.

Since the houses have been built by materials containing RaCO_3 the radon level inside the buildings are extremely high – about 3700 Bq/m³.

People within the LNT-group have suggested relocation of some of the families with the highest level of radon and radiation. This suggestion has not been followed since the health situation for these people is not different from others, in fact the opposite.

Yangjiang China



People living in the town of Yangjiang, located in China's southern Guangdong province, have traditionally built their homes from bricks made of sand and clay. Trouble is, the sand in the region has eroded from hills containing monazite and once incorporated in bricks and mortar, thorium in the monazite sand continues to decay into radioactive radium, radon and actinium. The residents in these areas live with a radiation level far above average.

Some studies have been carried out with two cohorts within this area. The two groups have an average annual dose of 6.4 mGy and 2.4 mGy – a difference of about 3. More than 100 000 people have been included and the studies involve more than 1.7 million person-years.

All these studies have failed to reveal any significant health effects that could be attributed to living in these areas of high natural background radiation. The LNT theory does not work! This holds true also for the Kerala-studies.

CONCLUSION: An increased cancer risk associated with the high levels of natural radiation in HBRA was not found. On the contrary, the mortality of all cancers in HBRA was generally lower than that in control areas, but not significant, statistically. This turned out to be – 0.11 per sievert (Sv) or Gy. Although the value is not significant, this indicates that mortality from cancer in HBRA tends to be slightly lower than in the other area – no excess cancer risk from exposure to terrestrial radiation far above normal.

It can be noted that in Ramsar they have carried out studies on chromosome aberrations after an extra dose of 1.5 Gy. The result was **fewer** chromosome aberrations compared to other residents in nearby control areas. The conclusion of this is that high level of natural radiation may induce a radio adaptive response. The radio adaption was found for individuals who received doses up to hundred times more than inhabitants of nearby control area.

Another observation from Ramsar is that 2000 people living in the highest radon areas show slightly lower rates of lung cancer compared to the control areas.

Summary

A large amount of people are living with background radiation far above the average. All studies on the health effects seem to indicate **no increased** detrimental effects – rather the opposite. According to the LNT-theory we should expect a clear effect and an increased cancer ratio.

The observed data from the high background radiation areas (HBRA) may have some bearing to the panic evacuations in combination to Chernobyl and Fukushima.

The counters in Pripyat close to the reactor reads now about 4.8 mGy per year. For the most contaminated areas around Fukushima the reading in May 2013 is about 2.9 mGy per year. Both places are evacuated in spite of the facts that they have a much lower radiation level than the HBRA areas.

Indoors

When inside houses and buildings, people may think they are shielded from much of the radiation coming from the outside. This is not always true.

Since the building materials also contain radioactive elements, the dose generally does not go down. More often it goes up. Since the concentration of radioactive isotopes varies from one region to another, it is also true that the radioactivity in building materials, such as concrete, depends on where it is made.

In houses made of wood, the γ -radiation in the ground floor is approximately the same as that outdoors. This is because most of the radiation comes from the masonry materials in the cellar and the ground just outside. Wood materials contain less radioactivity than rocks and soil and the radiation level decreases as you go to higher floors.

In houses made of concrete, the indoor radiation level will be like that of outdoors if the concrete is made from materials found locally. But it is not unusual for the concrete or cinder blocks to contribute to an increase in the radiation level over that found outdoors.

In Sweden, a number of houses were built using uranium rich shale. Because these houses have a radiation level that is unacceptable, construction using this type of building material was stopped in 1979. Houses made of red brick very often have a high radiation level, mainly because of the content of K-40. Brick houses are more common in cities than in the country; consequently, people living in cities tend to be exposed to more radiation than those living in the countryside.

Examples of the radiation level inside different types of houses in the same area are given in the figure below. The data are collected by graduate students at the University of Oslo, supervised by Anders Storruste. More than 2000 houses in southern Norway yield these data.

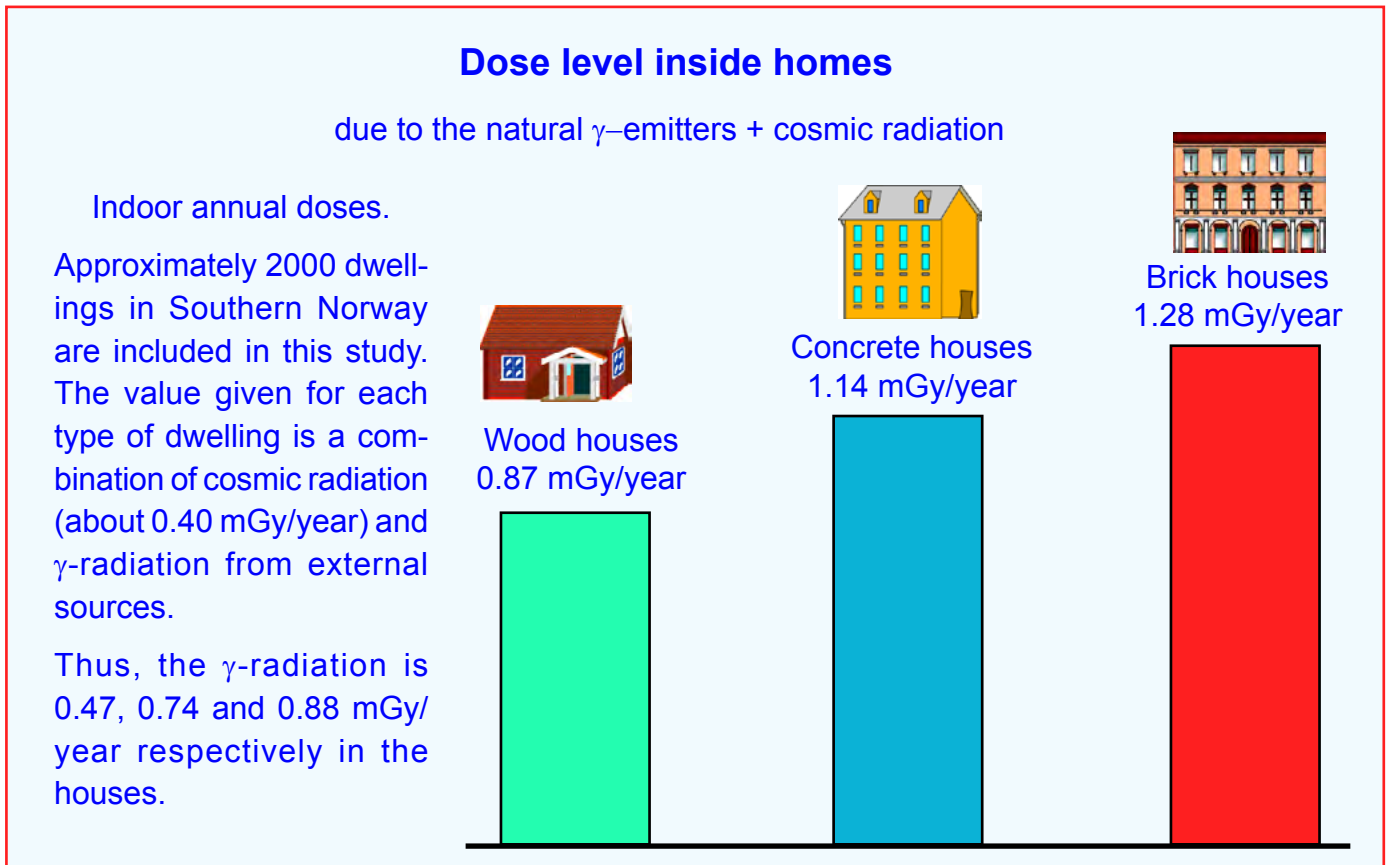

For different types of houses, the radiation level may vary by a factor 2. The lowest levels were found for wood houses. Here the annual indoor dose is 0.87 mGy from external γ -radiation and cosmic radiation combined.

It appears from the figure that, if you move from one house to another, you will also change your radiation environment. Your background dose will either increase or decrease. Consequently, if small environmental doses, either natural or artificial, are of some concern, it would be of interest to have information about the sources that contribute to the annual dose.

We can conclude that the external γ -radiation dose (coming from sources external to the human body) varies within large limits from place to place, and even from one house to another house in the same area.

UNSCEAR have collected data from almost all countries. It appears that the ratios of indoor to outdoor exposure are in the range from 0.6 to 2.3, with a population-weighted value of 1.4. Thus indoor exposures (absorbed dose rate in air from terrestrial gamma radiation) are, in general, 40% greater than outdoor exposures. If you look into the figure again you will see that the indoor γ -dose for brick houses is 87 % greater than that for the wooden houses.

UNSCEAR have also made attempts to estimate annual effective doses from the measurements of the radiation level outside as well as inside houses. One must take into account the conversion coefficient from absorbed dose in air to effective dose – and furthermore the indoor occupancy factor. These parameters vary with the age of the population and the climate at the location considered.

The result of such calculations yields a worldwide average of an annual effective dose of 0.48 mSv – within the range 0.3 – 0.6 mSv.

3. Internal Radioactivity (sources inside the body)

The food we eat and the air we breathe contains radioactive isotopes. Dust particles in the air contain isotopes of both the U-238 and the Th-232 series. We have therefore small amounts of radioactivity in our bodies.

The most important isotope with regard to dose is K-40. The daily consumption of potassium is approximately 2.5 gram. From this you can calculate that each day you eat about 75 Bq of K-40. Potassium is present in all cells making up soft tissue. The potassium content per kilogram body weight will vary according to sex and age (see figure next page). The dose due to K-40 will of course also vary in a similar way. Muscular young men receive a larger dose than older persons and men receive a larger dose than women.

Inhalation. The dominant component of inhalation exposure is the short-lived decay products of radon. They will be treated separately in the next section. The content of the other isotopes in the air (like U-238, Ra-226) is on average about 1 $\mu\text{Bq}/\text{m}^3$. However, the content of Pb-210 and Po-210 are 500 and 50 $\mu\text{Bq}/\text{m}^3$. Pb-210 is a β -emitter whereas Po-210 is an α -emitter.

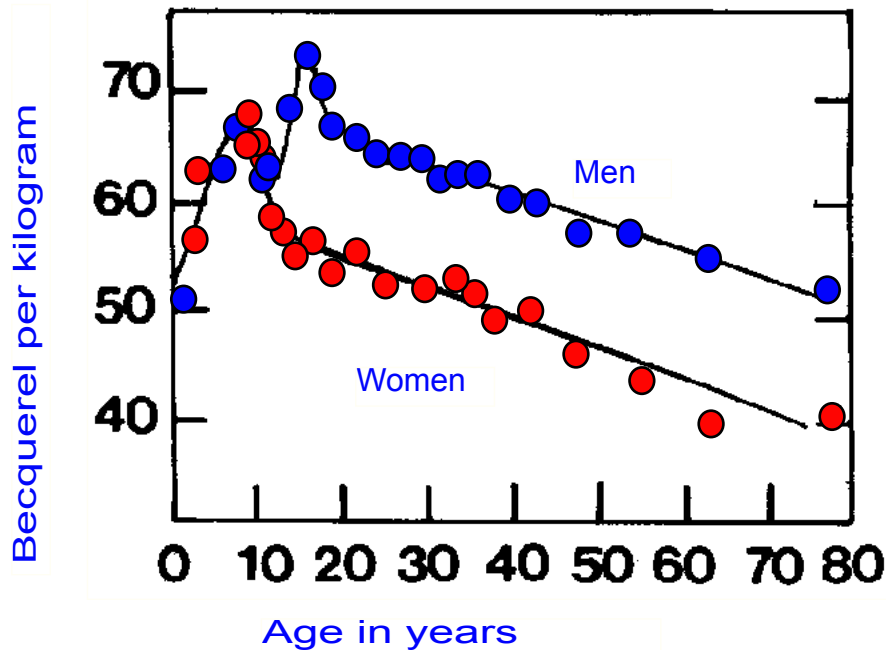

The concentration of potassium in the body varies with age and sex. Consequently the amount of K-40 (the abundance of the K-40 isotope is 0.0118%) varies in a similar way. In the figure the K-40 level is given as becquerel per kilo.

A simple calculation of the K-40 dose

Based on a K-40 level of 70 Bq/kg we can do a simple calculation of the annual dose from this isotope. You have to use the decay scheme for K-40 (see page 26). In 89.3 % a β -particle with average energy $1/3 \cdot 1.31$ MeV is emitted, and in 10.7 % a γ -photon with energy 1.46 MeV is emitted.

We calculate the energy to the body for one disintegration (in average) of K-40.

The β -particle energy is as follows:
$$\frac{89.3 \cdot 10^{-2} \cdot 1.31 \cdot 10^6}{3} = 42.92 \cdot 10^4 \text{ eV}$$

The γ -photon energy is:
$$\frac{10.7 \cdot 10^{-2} \cdot 1.46 \cdot 10^6}{2} = 7.81 \cdot 10^4 \text{ eV}$$

The sum of the two is: $1 \text{ Bq} \approx 51 \cdot 10^4 \text{ eV}$

For β -particles the average energy is approximately 1/3 of maximum – therefore the 3 in the denominator. All β -energy is deposited within the body.

For γ -rays a rather significant part will go out of the body. Thus, it is possible to use counters outside the body to observe K-40. In the expression above we have assumed that about half of the γ -energy is absorbed in the body. This is the reason for the 2 in the denominator. You see that the calculation is rather rough, but it gives you an idea how to use your knowledge.

1 Bq in a year represents $31.536 \cdot 10^6$ disintegrations (seconds per year).

Furthermore since 1 eV is $1.6 \cdot 10^{-19}$ J we have:

1 Bq/kg/year is $51 \cdot 10^4 \cdot 31.5 \cdot 10^6 \cdot 1.6 \cdot 10^{-19} = 2.6 \cdot 10^{-6} \text{ J/kg} = 2.6 \text{ } \mu\text{Gy}$

For 70 Bq per kg the annual dose would be; 182 μGy or (in line with ICRP) 182 $\mu\text{Sv} = 0.18 \text{ mSv/year}$.

UNSCEAR give a value of 0.165 – 0.185 mSv per year.

The other naturally occurring radioactive isotopes which come into our bodies are C-14 and a number of isotopes from the Uranium family (U-238, Th-230, Ra-226, Pb-210 and Po-210). From the thorium family (Th-232, Ra-228, Th-220 and U-235). A large amount of work and experiments have been carried out to find the average concentrations of these isotopes in our food products. With regard to annual doses we can give the following.

C-14

This isotope is formed in the atmosphere when neutrons react with nitrogen. C-14 is taken up by plants in the form of carbon dioxide, CO₂. The amount of C-14 in the body is about 35 Bq/kg. C-14 emits a β-particle with maximum energy 156 keV – an average energy of 52 keV per disintegration.

This would yield a body dose of approximately 10 μGy per year = 0.01 mGy/year or 0.01 mSv/year. You can carry out this calculation which is similar to that for K-40 (see page above).

Uranium and thorium series radio nuclides

UNSCEAR have, based on a large number of investigations, presented values about the annual intake by humans of the different isotopes. We can mention the following; Ra-226 (22 Bq/year), Pb-210 (30 Bq/year), Po-210 (58 Bq/year) and Ra-228 (15 Bq/year). The other isotopes have smaller intake.

Based on the concentrations of radioisotopes in foods and the consumption rates for infants, children, and adults the concentrations in the body have been calculated. Furthermore, the distribution throughout the body has been calculated based on models. U-isotopes, Ra-isotopes, Pb-210 and Po-210 are concentrated mainly to the bone (about 70 %).

Based on all the data from the different countries the UNSCEAR 2000 report arrive at an annual effective dose of 0.12 mSv. The main contributor to this dose is Po-210 (for this α-emitter UNSCEAR uses a weight factor of 20).

The amount of polonium in food varies. It is particularly high in reindeer and caribou meat because it concentrates in lichen, an important food source for these animals. Some people living in Lappland eat a lot of reindeer meat and, consequently, have Po-210 concentrations much higher than average.

The tobacco plant also takes up Po-210; thus, smokers get an extra radiation dose to their lungs.

If we sum up this, we can conclude that the world average effective dose due to the natural isotopes is;

301 μSv per year – or 0.3 mSv/year

4. Radon

We intend to treat the field with radon in 2 sessions:

1. The physical background, measurements as well as radon in homes.
2. Radon and lung cancer; dosimetry and epidemiological studies.

Radon is formed when radium disintegrates. Radon and its first 4 decay products, with rather short half-lives, are called the "*radon family*". We find one radon family in the uranium-radium series (see page 21) and one family in the thorium-series (also called the "*thoron family*").

Radon is a ***noble gas and does not combine chemically with other atoms or molecules***. The radon gas may be released from the place where it is formed and come into the atmosphere, both outside and into houses.

The half-lives for the two radon isotopes are 3.82 days and 55.6 seconds respectively. Both radon isotopes disintegrate into negative metal ions (called "*radon daughters*"). These ions become attached to water molecules and other molecules in the air and get a diameter of about 5 nm. In this form the radon daughters are considered to be ***free***. The majority of the radon daughters become attached to larger aerosol particles in the air (from 50 – 500 nm in diameter). Both the free and the bound daughters will deposit on the walls, roof and floor inside and to the ground, trees, houses, etc. outside. Consequently, it will never be equilibrium between radon and radon daughters in the air we are breathing, For the air inside the houses the equilibrium factor is about 0.4 whereas for the outside air it is about 0.8.

The radiation from radon and its decay products is a mixture of α -particles and β -particles as well as γ -radiation. As long as these isotopes are outside the body, only the γ -radiation will be able to give a dose. However, when the isotopes come inside the body, all types of radiation contribute. Since the α -particles have the largest energy (in the range from 5 to 8 MeV) they are the most important for the dose (more than 80 % of the absorbed energy is due to the α -particles).

The amount of isotopes ingested with the food is negligible, and all concern is about the breathing and the deposition of radon daughters in the bronchi and in the lungs. For a long time we have been aware of the health risks associated with high radon exposures in underground mines, but relatively little attention was paid to environmental radon exposures until the 1970s, when some scientists began to realize that indoor radon exposures could be quite high, because the local concentration of uranium and/or thorium is high. At the same time the radiation weight factor of 20 was introduced for the α -particles in the radon family.

In the following we shall try to give you some information about the radon families – the physical aspects, measurements in dwellings, estimations of annual doses and the relation to lung cancer.

The Radon Family – physical aspects

Most of the physical aspects are given in the two tables on the next page. In the second column is given the decay type. We know that γ -radiation very often is emitted together with the particle (see the decay schemes in Chapter 2).

The energy of the different particles and γ -radiation is given in the last column. In the case of the β -particles the maximum energy is given. We would remind you that the average β -energy is approximately 1/3 of the maximum energy. The α -particles have the largest energies (in the range from 5.49 to 8.78 MeV). The range in soft tissue is about 50 to 100 μm .

(It is a long way to go from the measurements of radon in the air to an estimation of the effective doses from the radon and thoron families. In the following we shall try to give you some information about radon in the atmosphere, how it is measured, and how effective doses have been estimated.

The Uranium – radium series

Isotope	Decay type	Half-life	Energy released (in MeV)
Rn-222	α	3.82 days	α with energy 5.49
Po-218	α	3.05 minutes	α with energy 6.0
Pb-214	β	26.8 minutes	β with maximum 0.59 and 0.65 γ with energy 0.053 and 0.35
Bi-214	β	19.6 minutes	β with maximum 1.51, 1.0 and 3.18 γ with energy 0.61 and 2.42
Po-214	α	0.164 msec	α with energy 7.69
Pb-210	β	22.3 years	β with maximum 0.015 and 0.061
Bi-210	β	5.01 days	β with maximum 1.16
Po-210	α	138.4 days	α with energy 5.3
Pb-206	Stabile	Stabile	

In this table Rn-222 and the 4 decay products (Po-218, Pb-214, Bi 214 and Po-210) are members of the radon family. However, when Po-214 decays the radioactive decay product Pb-210 is formed. The half-life is 22,3 years and Pb-210 and the following two decay products are not considered to be members of the radon family.

The Thorium series

Isotope	Decay-type	Half-life	Energy released (in MeV)
Rn-220	α	55.6 sek	α with energy 6.28
Po-216	α	0.156 sek	α with energy 6.78
Pb-212	β	10.6 timer	β with maksimum 0.34 and 0.58 γ with energy 0.239
Bi-212	α (34 %) β (66 %)	60.6 min	α with energy 6.05 β with maksimum 2.25 γ with energy 0.04
Po-212	α	$3 \cdot 10^{-7}$ sek	α with energy 8.78
Pb-208	Stabile	Stabile	

Comments on thorium series

You see from the table that Bi-212 has two possibilities for decay; either α -decay (34 %) or β -decay (66 %). The α -decay yield Tl-208 which then by β -decay reach Pb-208. The other possibility goes via Po-212 followed by α -decay and reach again the stable Pb-208 isotope.

The Tl-208 isotope decays via β -particles (energies of 1,79, 1,28 and 1,52 MeV) and accompanying γ -radiation. One of these γ -lines have an energy of 2.61 MeV. This line is used to identify the thorium series in a mixture of γ -radiation (see for example chapter 14).

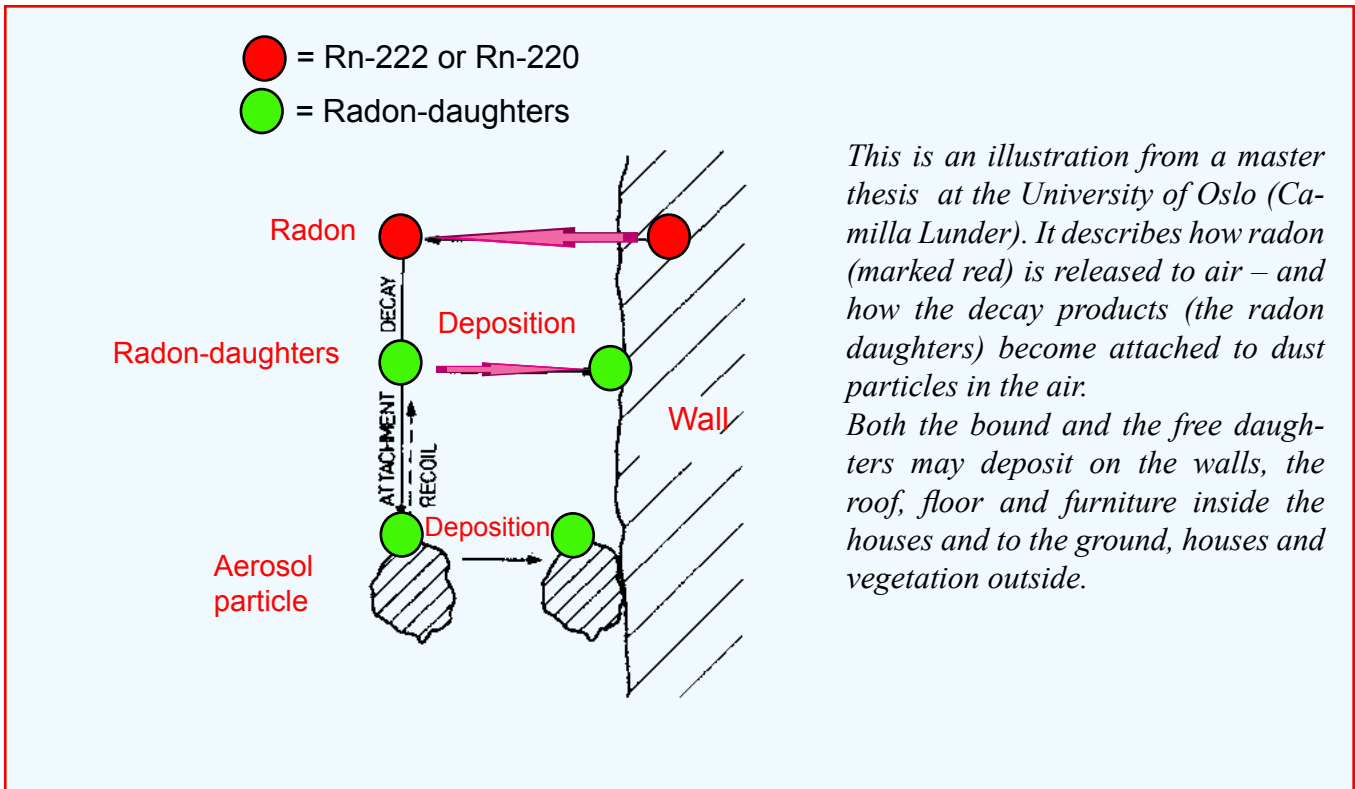

The radon sources

The two radon isotopes Rn-222 and Rn-220 are formed from the radium isotopes Ra-226 and Ra-224. The distribution of radium follows the distribution of uranium (U-238) and thorium (Th-232).

It is important to note that radon is a **noble gas**, whereas all the other isotopes in the two families are metals. The gas may be trapped in the soil until it decays, but it is the only isotope that also has a chance to be released to the air. When radon disintegrates, the metallic daughters are ions that will be attached to other molecules like water and to aerosol particles in the air.

The radon concentrations in the soil within a few meters of the surface are important for the entry into the atmosphere. The main mechanism for this is molecular diffusion.

The concentrations of Rn-222 in soil vary over many orders of magnitude from place to place and show significant time variations at any given site. Because of the short half-life of thoron (Rn-220) in the soil, a large fraction of the atoms will disintegrate before they reach the surface.

Radon measurements

The methods for measuring radon has developed considerable during the latter years. Today we have instruments that make it possible to follow the radon concentration as a function of time, the concentration of the different radon daughters, as well as the fraction not bound to particles.

For indoor radon measurements we can use charcoal canister sampling and thermoluminescence dosimeters (TLD). This method consists of a small box with carbon powder and two TLD crystals. One crystal is placed in the middle of the box whereas the other is outside the box. Radon daughters from the air will become trapped in the carbon powder and subsequently expose the crystal in the box. The crystal outside the box serves as a control for the cosmic radiation and gamma radiation from the walls of the room.

The difference between the two TLD-crystals yields information on the average radon concentration during the exposure period. The first mapping of radon in Norwegian dwellings were performed using this method by A. Storruste and his students at the University of Oslo around 1960.

Another new and popular method is the solid-state nuclear track detectors. The method is based on the fact that α -particles make tracks in certain materials such as polymers, minerals or glass. The tracks are made visible upon etching and then examined microscopically. The size and shape of these tracks yield information about the mass, charge, energy and direction of motion of the particles.

Radon concentrations are determined by measuring the emitted alpha particles and the track detector has become the state-of-the-art for environmental radon monitoring.

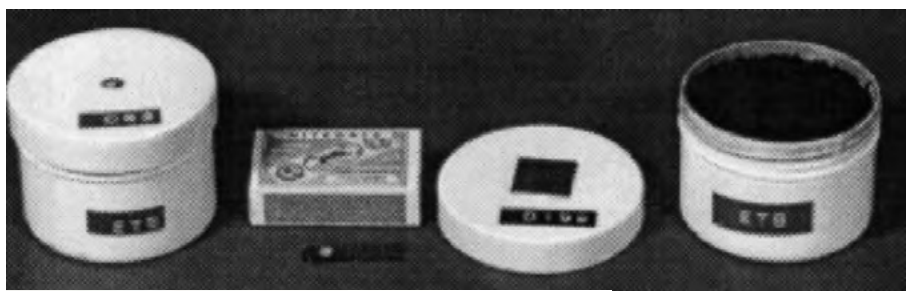

Above is a picture of the coal box method used by Storruste in the first Norwegian measurements. Below is a modern nuclear track detector. These pictures give rather little information about the measurements, but are presented to give an impression of the size of the detectors.

Both detectors are used for indoor measurements – and give information about the average radon concentration for the period measured.

Radon into the houses

Several possibilities exist for the release of radon into houses (see illustration on the next page).

The main sources are the rock or soil on which the house is built, as well as the water supply. The rock formations under a house always contain some radium and the radon gas can penetrate into the house through cracks in the floor and walls of the basement. Furthermore, the building materials is also a source for radon.

Another source for radon is the water supply. Water from wells, in particular in regions with radium-rich granite, may contain high radon concentrations. When water is the carrier, the radon gas is readily released.

The indoor radon concentrations usually show an annual variation with the largest values during the winter. This is quite usual in places with frost and snow on the ground. The frost makes it difficult for the gas to diffuse out of the surrounding ground and to be released directly into the air. Consequently, the radon gas is more likely to seep into the house. It is the radon concentration averaged over a long-time that is important with regard to health risk and, consequently, remediation. Decisions on what action to take are generally based on an average annual level.

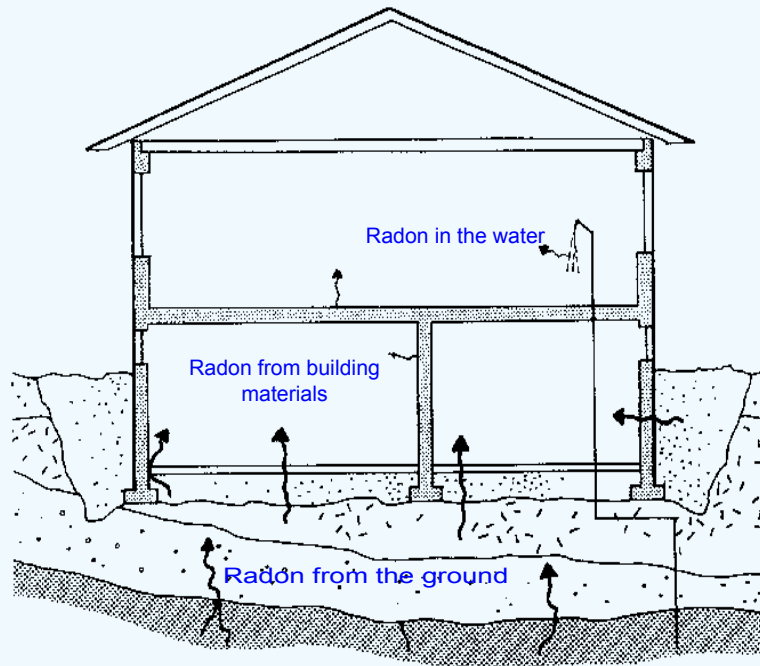

This drawing illustrates how radon may enter a house. The radon gas (originating from radium) comes into the house from the ground, from the building materials and sometimes from the water. Well water contains in some areas (for example in Finland) quite large amounts of radon which is released when used in showers or in the kitchen. Drinking the water increases the amount of radiation to the body. In this connection we are interested in inhaled radon daughters.

(Courtesy of Terje Strand, Norwegian Protection Agency)

Radon measurements around the world

The UN organization UNSCEAR has collected measurements carried out around the world and presented data in several reports. Some of the data presented in the report from 2000, will be given.

The main mechanism for the entry of radon into the atmosphere is diffusion. In the outdoor atmosphere, there is also some advection caused by wind and changes in barometric pressure. Furthermore the concentrations of Rn-222 in the soil gas vary over many orders of magnitude from place to place and show significant time variation at any given site.

According to UNSCEAR, the flux of Rn-222 to the atmosphere is of the order $0.02 - 0.03 \text{ Bq m}^{-2}\text{s}^{-1}$. From the outdoor radon measurements it appears that the concentrations of Rn-222 and Rn-220 are approximately 10 Bq m^{-3} for each. There is, however, a wide range of long-term average concentrations of Rn-222, from approximately 1 to more than 100 Bq m^{-3} .

Radon (world average)

UNSCEAR 2000

Outdoor: 10 Bq m^{-3}

Indoor: 46 Bq m^{-3}

Indoor measurements

Radon measurements are carried out in all countries around the world and UNSCEAR presents tables of the values like the one below. In the report from 2000 the world average indoor value is 46 Bq m^{-3} . In the table below we have quoted the values for some selected countries – the values may change when more measurements are carried out.



In Kinsarvik in the western part of Norway the highest radon values have been measured – both inside the houses as well as for the outside air:

Values above $50\,000 \text{ Bq m}^{-3}$ inside and up to 287 Bq m^{-3} outside (1 meter above the ground) have been measured

Indoor Radon values (UNSCEAR 2000)

Country	Average Bq m^{-3}	Maximum Bq m^{-3}
United States	46	
Canada	34	1720
China	24	380
India	57	210
Iran	82	3070
Denmark	53	690
Finland	120	20 000
Norway	73	50 000
Sweden	108	85 000
France	62	4690
Germany	50	10 000
United Kingdom	20	10 000
Australia	11	420

Some comments on the indoor radon level

The inside radon level vary considerable with weather, time of the year and even time of the day – and of course with the airing system. For example, sleeping with an open window can reduce the radon content considerable. An example of airing is given below. After 1 hr the radon level was reduced by a factor 5 – 10. Afterwards the radon content increased and reached the old values in about 8 – 10 hours.

In places where water is the source for the radon release, the use of water for cooking, for showers, etc. will increase the radon level.

A reducing factor is air-condition. The radon level can be reduced by a large factor.

In conclusion. The radon level inside homes and other buildings can be measured with good accuracy. Old methods like ventilation and new methos with air-condition can reduce the radon content.

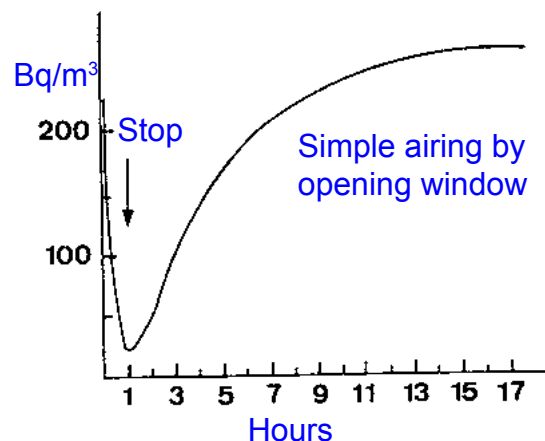

Radon and lung cancer



In chapter 13 we discuss the mechanisms for cancer development – in particular radiation induced cancer. However, it seems reasonable – at this point – to present some of the discussions and studies carried out to evaluate the connection between the radon level in homes and lung cancer.

The fundamental for radiation induced cancer is the **radiation dose**. It is the ionizations and excitations formed when radiation is absorbed that initiate the chain of reactions that finally give an observed tumor.

In the studies of radiation induced cancer it is often easier to observe the medical result – namely the cancer – compared to observe the physical part, namely the radiation dose. This holds true for all internal dose calculations such as radon and also the intake of radioactive isotopes via food. On page 101 we have given an example how to calculate the dose from K-40 in the body, and in the next chapter we calculate the doses from intake of Cs-137 via food.

External exposure

Radiation induced lung cancer can be observed after **external exposure** to x- and γ -radiation. A number of different groups have been irradiated with small and larger doses that can be measured fairly well. The results of this give us some information about radiation induced lung-cancer. The published data are given in the figure.

Low LET external radiation

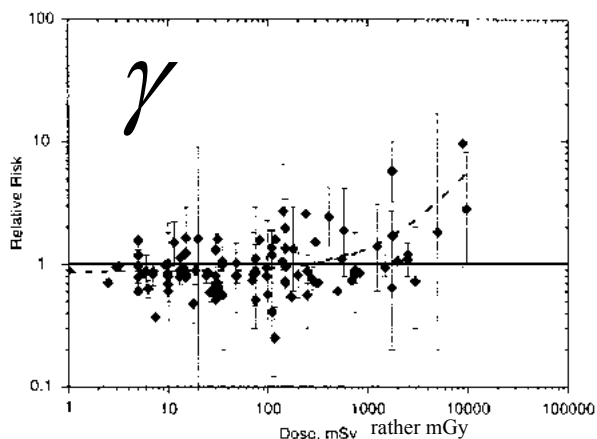

Here you see a number of epidemiological studies of the correlation between lung cancer and radiation dose.

In these studies the radiation is external and consists mainly of γ -radiation and a small fraction of β -particles. It is low LET-radiation.

Although the data are heterogeneous, they indicate some type of radiation protection (radiation hormesis) for doses below 1 Sv or rather 1 Gy.

The figure is from the book of Charles L. Sanders: "Radiation Hormesis and the Linear-No-Threshold Assumption"

Let us note that in the case of external low LET-radiation there is no linear correlation between lung cancer and radiation dose. Both parameters are fairly well determined. A question that can be raised is if high LET-radiation would give another result.

Since we have no human results we would like to present an experiment with dogs.

Experiments with lung cancer formation by α -particles in dogs



Since about 1970 a group connected to Pacific Northwest National Laboratory in Oregon have carried out life-span studies of dogs that inhaled plutonium oxide. The radioactive isotope is Pu-239, with half-life 24400 years. The decay scheme of Pu-239 is α -particles with energy 5.15 MeV and γ -radiation with a line of 53 keV, which makes it possible to observe the isotope from outside the body with a γ -camera.

The biological half-life was 3.26 years – and the dogs were exposed until death.

The dose in Gy was fairly well determined – we can not give any dose in Sv since we operate with dogs.

The overall lung cancer incidence in 137 exposed dogs was best represented by a pure-quadratic equation. However, for accumulated doses below 2 Gy some interesting results appeared as shown in the figure below.

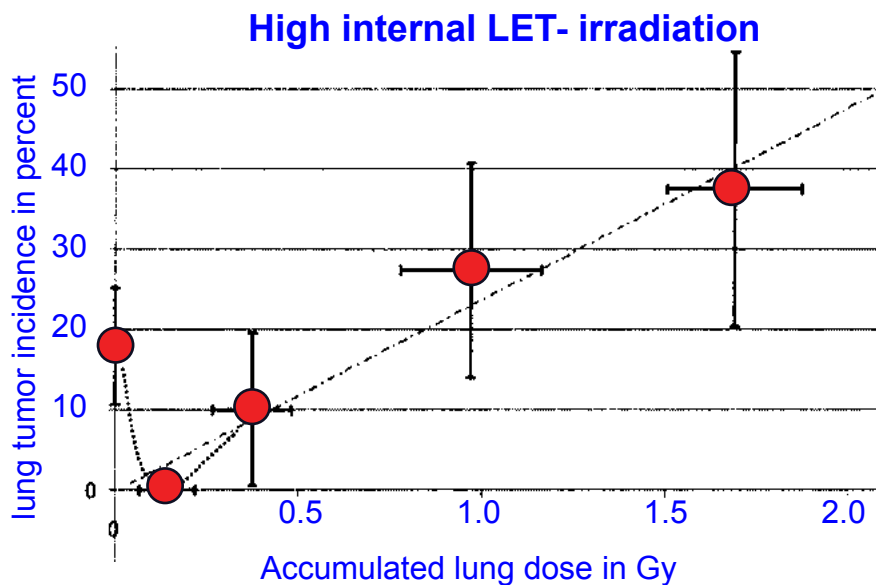

The data for doses below 2 Gy supported a threshold effect for α -particle induced lung cancer. Un-irradiated dogs (the controls) exhibited a higher lung cancer level than those irradiated with doses up to about 0,7 Gy. The data showed that chronic low doses may be beneficial and give an advantage effect compared to unirradiated subjects.

The data indicated the likelihood that low doses of α -particle radiation protected and reduced the incidence of lung cancer relative to the controls.

We would like to have these results for low and high LET-radiation in mind when we embark on the much more complicated issue to evaluate the effect of the indoor radon level on the induction of lung cancer.

The, by far most important cause of lung cancer, is smoking. Furthermore, smoking has an important effect on destroying the lungs cleaning system. This implies that the radon daughters connected to the aerosol-particles will not be stopped in the same way for smokers compared to non-smokers.

Radon Doses – system I

Several attempts have been made to calculate the energy deposited in the lungs. These calculations are not easy since several important factors are unknown. We shall now go through some of the efforts done to arrive at the dose level from inhaled radon daughters.

We have the following situation: You are exposed to radon and radon daughters from cradle to grave. Each time you breathe, more radioactive daughters are inhaled. The half-lives for the daughters are very short and the radiation dose is given within the day. If, however, some of the particles in the uranium series remain within the lung system, we will eventually have a small contribution from the decay of Po-210 (α -particle) as well as from Pb-210 and Bi-210.

Let us try to describe how radon doses may be *estimated* based on human models. The models take into account both physical and biological parameters.

Dose estimations. We breathe in an atmosphere consisting of radon and radon daughters. Since the daughters are attached to aerosol particles, they are easily deposited both indoors and outdoors. Consequently, the number of daughters in the air is approximately 40 – 60 % compared to radon itself. We do not know the correct number.

Radon and radon daughters will follow the air into the lungs when breathing. Radon itself will mostly follow the air out again. If we assume that the average air volume in the lungs is 1 – 2 liter, about 0.1 to 0.2 radon atoms may disintegrate in the lungs per second (0.1 – 0.2 Bq). This gives a minor contribution to the dose. Consequently, it is the radon daughters that give the radiation dose.

Some of the factors that are important for the amount of radon daughters inhaled are:

1. The aerosol size distribution as well as the equilibrium factor between free and bound radon daughters are important. The free radon daughters will penetrate and deposit deeper into the lungs. UNSCEAR is using an equilibrium indoor factor of 0.4 and an outdoor factor of 0.6.

2. The amount of radon daughters that enter the bronchi and lungs depend on the intake of air by breathing. In one of the models used by UNSCEAR it is assumed that an adult man breathe 22.4 m³ air per day and a woman 17.7 m³ per day.

3. The important target cells may be reached by the α -particles. The depth in tissue for the target cells have been observed, and a value of 27 μm for men and 18 μm for women has been used.

4. In order to convert absorbed energy; i.e. the dose in Gy to Sv we have to apply a radiation weight factor. ICRP recommends a radiation weight factor of 20 for the α -particles. This value is highly uncertain. The weight factor for the β -particles and γ -radiation is 1.

It can be noted that when the radiation weight factor of 20 was introduced (in the 1970-ties) the equivalent dose (in Sv) increased by a factor 20, and this changed our concern about radon completely.

5. Only the lungs are irradiated by the radon family and in order to arrive at an *effective dose*, we have to apply the tissue weight factor for lungs (ICRP suggests 12 % for the lungs).

6. Since the radon content is much higher inside the houses we have to assume a value for the indoor occupancy. UNSCEAR use an indoor occupancy of 80 % – about 19 hours which is much larger than average.

Result: In the UNSCEAR 2000 report a world average person obtain an accumulated annual dose from the radon and thoron families of the order 1.2 mSv. The Rn-222 family accounts for more than 90 % of the dose. Using the same estimation procedure the **annual effective** dose in Norway would according to this, be approximately 2.0 – 2.3 mSv. The **lung dose** would be about 16 – 18 mSv – or **0.8 – 0.9 mGy** when the weight factor between Gy and Sv is omitted.

The accumulated lung dose of α -particles over a period of 50 years would be 40 – 45 mGy. We use the unit Gy in order to compare this dose to the α -dose for the dogs mentioned above. Such a dose would give the dogs a significant protection!

The lungs cleaning system

A very important point in all dose estimations is the fact that the airways and lungs has a cleaning system. ***This seems to have been ignored in all epidemiological studies. Consequently all dose estimations become more or less a guesswork.***

Let us give some facts about the lungs cleaning system. The bronchial tubes are lined with ***cilia*** (like very small hairs) that have a wave-like motion. This motion carries mucus (sticky phlegm or liquid) upward and out into the throat, where it is either coughed up or swallowed. The mucus catches and holds much of the dust, germs, and other unwanted matter that has invaded the lungs. You get rid of this matter when you cough, sneeze, clear your throat or swallow.

With regard to radon it is evident that parts of the aerosol particles are swept out of the lung system before the radiation is emitted. ***However, we have no information about how effective this systems works – and how it changes from one person to another.***

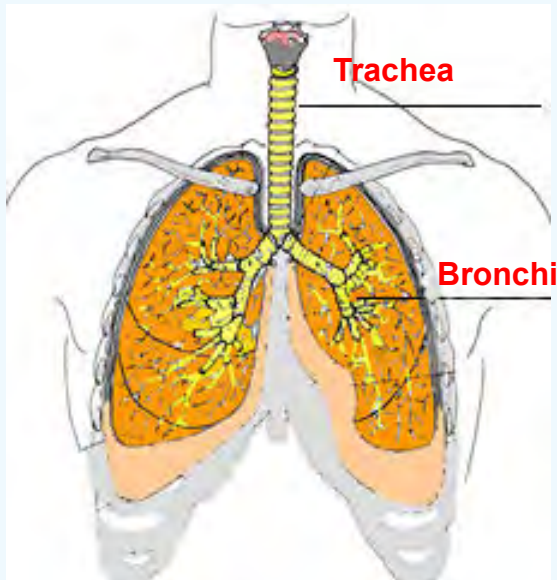

Smoking destroys cilia – the lungs' natural cleaning and repair system. This system in general, and the cilia in particular, are paralyzed and destroyed by the poisons in cigarette smoke. However, functioning cilia can begin regenerating within a few days of quitting smoking, and may completely return to their original functioning after an extended period; statistics show that people who have quit smoking reduce their risk of developing lung cancer to that of a person who has never smoked, within 10 to 15 **years** after quitting.

Above is an illustration of the lungs and bronchi. Radon and radon daughters (both free and bound) enter this system when breathing. Radon itself will not be stopped in the lungs, but follow the air out again. The radon daughters may be deposited in the walls of the bronchi and down in the lungs.

The lungs cleaning system consists of cilia that move in a sweeping motion to keep the air passages clean. Since the cilia and their function are damaged by cigarette smoke it implies that smokers get a larger radon dose than non-smokers. We have no quantitative information about this. However, two persons living in the same house get different lung doses. This uncertainty in radon dose are connected to all dose estimations – however it is not mentioned in any of the epidemiological studies.

Radon dose system II – used for underground miners

We know that radon in old mines involved a health risk for the miners. As early as around 1500, lung disease was found in two regions of Germany and Czechoslovakia, Schneeberg and Joachimsthal, among miners. The miners developed a deadly disease, called "Bergkrankheit". Between 1876 and 1938, 60 % to 80% of all miners died from the disease which, on average, lasted 25 years. Certain regions of the mines were known as "death pits," where all workers got sick. Bergkrankheit was mainly lung cancer and a result of their work and was recognized as an occupational disease.

It was mainly silver in the mines and it was made silver coins (called "thaler"). However, the mines contained pitchblende and consequently uranium, which at that time was considered to be of no value. From uranium the way to radon is clear and the mines contained radon and radon daughters.

The atmosphere in underground mines contains several *other* carcinogenic compounds, like arsenic and silica dust and diesel exhaust from mining machinery. Furthermore, the majority of the miners were smokers.

The radon concentration in the old mines are unknown, but they may be very large. Thus, measurements published in 1924 confirmed that the air in the mines contained high concentrations of radon gas, the highest more than 18 000 picocuries per liter – or 666 000 Bq m⁻³. It would therefore be of interest to arrive at the exposure rate and accumulated lung doses – or effective radon doses for those who worked for years in the mines. All the dosimetry is carried out in recent years and consists of exposure level and the product of the exposure level and time on work.

Exposure

The unit for exposure was called "*Working Level*" (WL). The working level unit was defined as the amount of radon and radon daughters in 1 liter air that give a total α -particle energy of $1,3 \cdot 10^5$ MeV.

For an equilibrium factor between radon and radon daughters of 1.0, one WL correspond to 100 pCi per liter (or 3700 Bq m⁻³), whereas for an equilibrium factor of 0.5 the WL unit correspond to 200 pCi per liter (7400 Bq m⁻³).

Dose

The workers in those days worked 40 hours per week, or 170 hours per month. This gives the unit for total exposure or "dose"; called "*Working Level Month*" (WLM).



$$1 \text{ WLM} = 1 \text{ WL in 170 hours}$$

Several attempts have been made to estimate a dose of 1 WLM into the more usual dose units such as Gy and Sv. Using the dose models suggested by UNSCEAR, it appears that 1 WLM is equivalent with an **effective dose** of the order 4 – 5 mSv. This again corresponds a **lung dose** of the order 1.6 mGy to 2.0 mGy! An accumulated dose of 200 WLM may be considered with a lung dose of the order 400 mGy or 0.4 Gy (compare with the doses to the dogs on page 110).

Lung cancer for the miners

Several retrospective cohort studies have been made and some conclusions can be drawn. An excess number of lung cancers have been found – even for nonsmokers. The risk increases with dose. In some of the reported studies it is possible to draw a straight line between the dose given in WLM and the relative risk. The straight lines indicate a threshold value of from 300 to 700 WLM.

Another point that should be mentioned is that the old German data seem to indicate that the risk was at a maximum in the period 15 – 24 years after exposure – indicating a latency period of that length.

The observation of lung cancer among miners seem to indicate a threshold value. Thus no cancers have been observed for non-smokers for accumulated doses below 100 WLM.

An α -particle dose of 300 WLM (probably a threshold dose) is equivalent with a lung dose of about 600 mGy. This is quite interesting when we compare with the experiments on dogs (page 110). For the dogs the threshold dose was about 700 mGy.

Radon dose system III – radon in homes

We know that exposure to large radon doses may give lung cancer. However, we can not extrapolate the observations for the underground miners to the radon values observed in most houses. For example if we live in a house with a constant radon level of 100 Bqm⁻³ the accumulated annual dose is about 0.4 – 0.7 WLM (assuming an equilibrium factor of 0.5). The accumulated lifetime radon dose is about 20 WLM. This is much lower than the threshold values for the underground miners.

A large number of epidemiological studies on radon in homes and lung cancer have been published during the last 30 years. **The aim of such studies is to give a plot with the radiation dose to the lungs along the horizontal axis and the radiation induced lung cancer along the vertical axis.**

First a few words on lung cancer

Lung cancer is by far the leading cause of cancer death among both men and women (see the figure below for the Nordic countries).

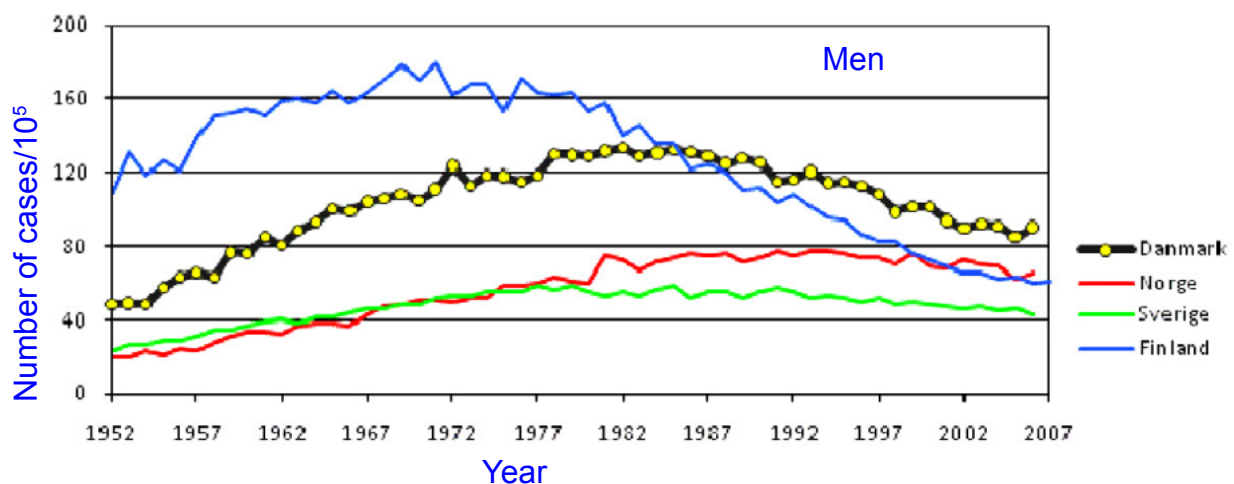

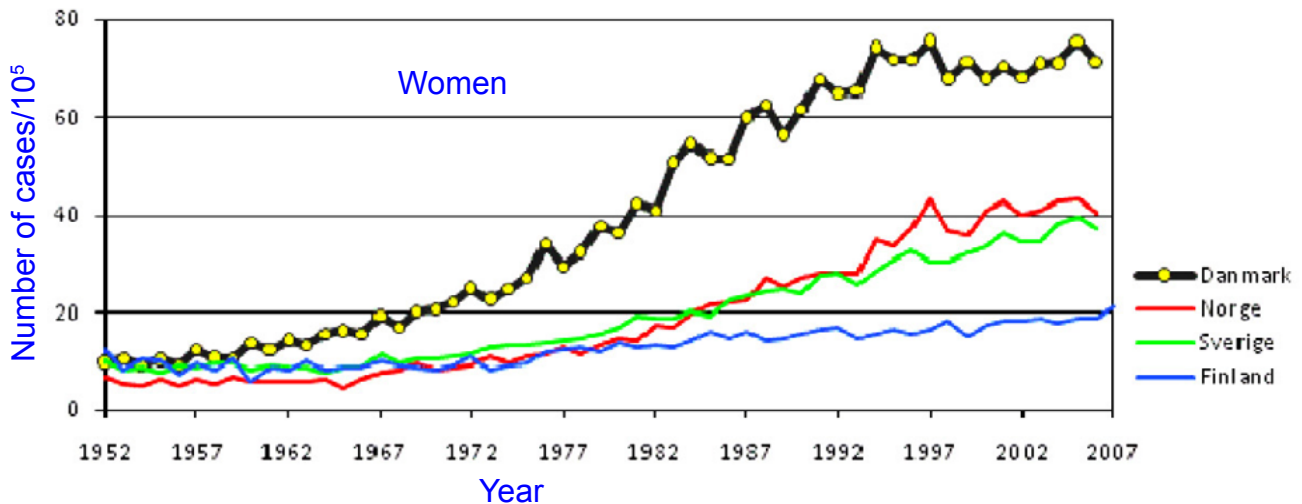

The two figures show the lung cancer deaths in the Nordic countries for the period 1952 to 2007 given as cases per 100 000 persons. It was an increase after the second world war, which has flattened out for men and started to go down again. For women the curves are somewhat different, but seem to have reached a maximum and may hopefully go down again together with the smoking habits.

The main cause for lung cancer is smoking. We assume that about 90 % (in the range from 80 to about 95 %) of the cases are due to smoking. The other causes are asbestos, diesel fumes, radiation and nature itself (see a more extensive discussion on DNA-damages and cancer in chapter 13). It is impossible to identify and determine those cases that are caused by radiation. Consequently in a plot on lung cancer versus radon, all lung cancers cases are plotted along the vertical axis.

Dose

Along the horizontal dose axis the radiation dose to the lungs should be given. The lung dose from inhaled radon daughters is unknown and, as discussed above, impossible to arrive. In the epidemiological studies another parameter – hopefully equivalent to the dose – has been introduced. The dose parameter introduced is **the radon level in Bq per cubic meter**. This parameter is more or less equivalent to the old WL exposure. In the case of the miners the dose was given in units of WLM where a WLM was the dose after 170 hrs at the exposure level of 1 WL. In most of the epidemiological studies the dose is given by the bequerel-level you have lived with for about 30 years. Since no one carry a personal dosimeter a number of assumptions are made:

1. The time inside the home is set to 80 % of the total. This may hold true only for retired people.
2. The radon level outside the home – in your work and your outdoor time is not recorded.
3. **The lungs cleaning system** is not mentioned. Consequently, two or more people living with the same radon level – **will not** be exposed to the same radiation dose!

We are here faced with a parameter that to a large extent seems to abolish the epidemiological studies. It is by far not enough to divide between smokers and nonsmokers – even though smoking has a large effect on the cleaning system.

Furthermore, the power of case-control studies disappears since it is impossible to arrive at a control group with the same radiation dose.

The ecological studies are not hampered by the cleaning system in a similar way – and become more important due to the large number of persons included.

In conclusion: For the many epidemiological studies carried out, the physical part (the radiation doses to the lungs) are extremely poorly determined. It is a surprise to the present author that the epidemiologists dare to draw firm conclusions based on this.

An overview of the epidemiological studies of radon and lung cancer

A large number of epidemiological studies have been carried out for the correlation between lung cancer and radon in houses. We shall present some of these studies – 3 case-control studies and 1 ecological study.

As mentioned above the radiation dose is replaced by the radon level in the houses, given in Bq m^{-3} . *No attempts have been made to take into consideration the cleaning system of the lungs. The smoking habit is not enough.*

Case-control studies

In general, we assume that the case-control studies give the most and best information. However, in the case of radon and lung cancer, it is more or less impossible to arrive at control groups mainly because we can not evaluate the lungs cleaning system. Thus, two persons living with equal becquerel level may obtain very different radiation dose to the lungs – even if they are non-smokers.

The "dose" in the case-control studies is usually given as the average radon level during 25 – 30 years, ending 5 years before diagnosis. The radon level is determined both by measurements and assumptions about the radon level for periods without measurements.

We would like to present 3 groups of case-control studies which yield different results.

1. Sarah Darbu and Daniel Krewski – pooled studies

Sarah Darbu et. al.(2005) presented pooled data from 13 studies in 9 European countries including 7148 cases and 14208 controls. Daniel Krewski et.al. presented data from 7 studies in USA including 4420 cases and 5707 controls.

These studies can be presented together since they both have based the studies on the LNT-theory. Thus, they assume that the data should be given in a linear plot between lung cancer and the level of Bq per square meter in the homes. *The purpose of the studies is to determine the increase in cancer incidence per 100 Bq/m^3 increase in radon level.*

The main results are given in the figures on the next page. The weakness in these studies is the radiation dose – or the Bq-level measured. No discussion is made on the radon level and the time spent outside the home, and no discussions are presented on the effect of the lungs cleaning system as well as the validity of the LNT-model.

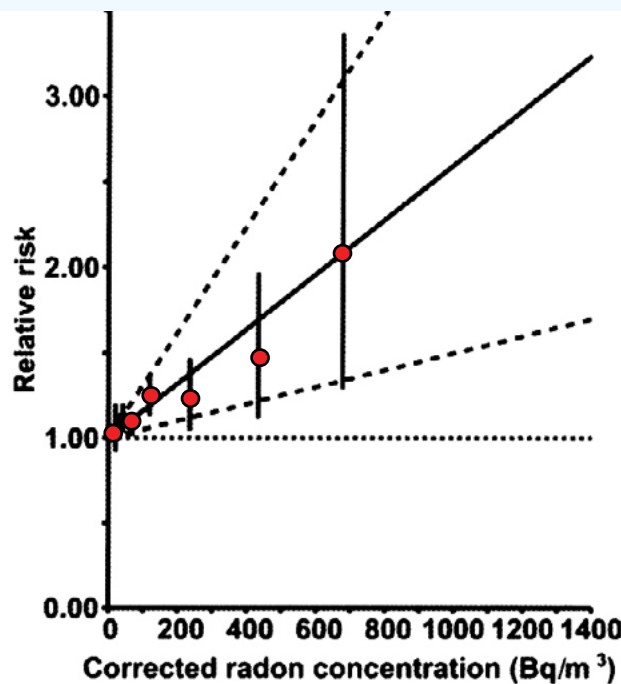
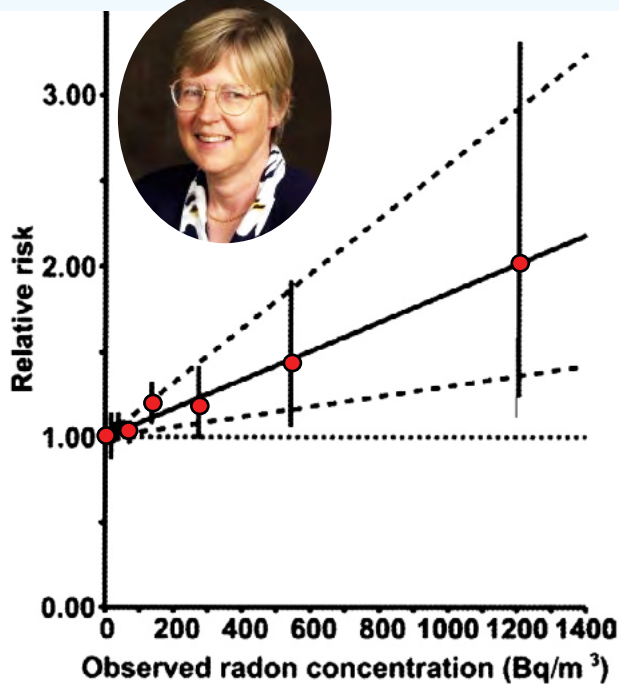

Above Darbus data are given. To the left is given the measured amount of radon in the homes in Bq per cubic meter. In the figure to the right the same data are given, but the "dose-axis" are corrected to imply the long term average of the radon content. In these plots the risk for lung cancer increases by 8 % per 100 Bq/m³ whereas in the right figure the increase is 16% per 100 Bq/m³. For non-smokers no measurable increase was found.

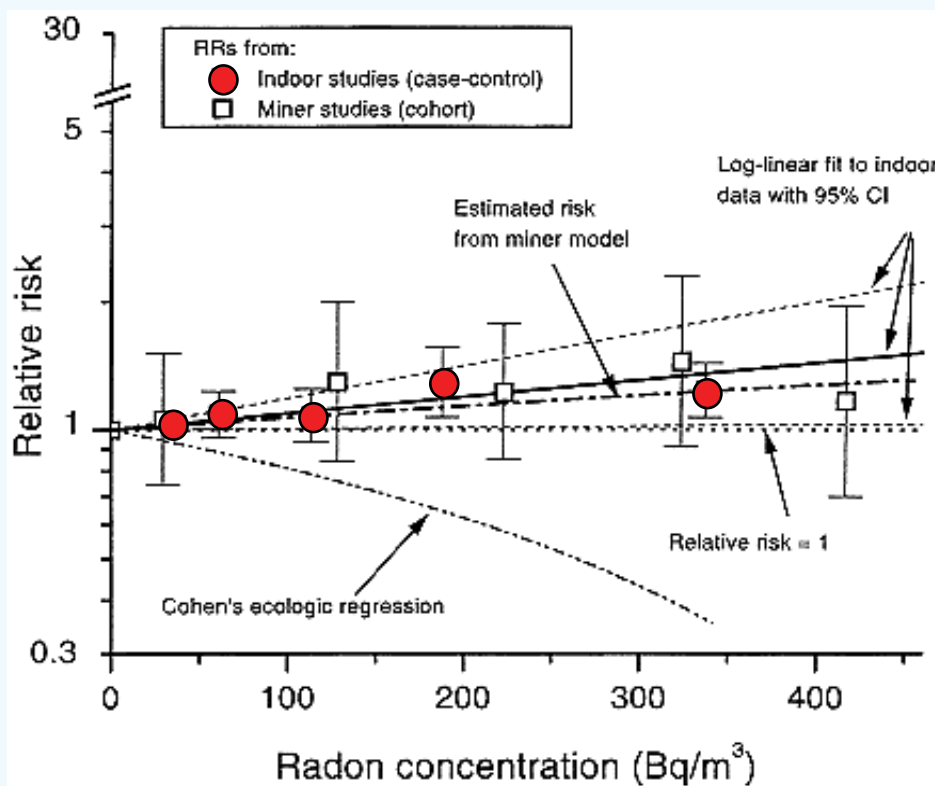

The data presented by Krewski et. al. In this figure is also presented the data from the BEIR VI report. The miner data are extrapolated to the very low values of radon. The extrapolation is based on LNT. Furthermore, the dotted line include the data from Bernhard Cohens ecological studies (see later). The straight line indicate an increase in lung cancer of 9.6 % per 100 Bq/m³.

2. Richard Thompsons and Donald Nelsons studies from Massachusetts 2008

The number of cases in this study was much smaller than those above. Thus 200 cases and 397 controls. They divided the cases in 6 groups with regard to radon content in the homes. The lowest value 25 Bq/m³ was used as reference. No preassumption about LNT was made. The results are given below.

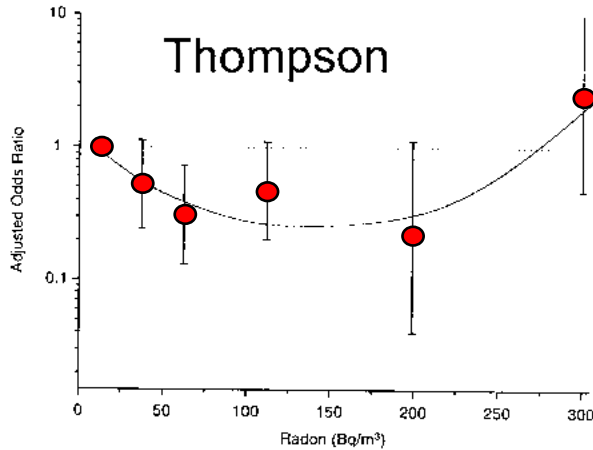

Here are the results from Massachusetts. It was a surprise that the data showed a clear hormetic effect. The range in "dose" or Bq/m³ is rather very limited.

3. The Schneeberg studies

Schneeberg is a small German city close to the border of the Czech Republic. The city is known for high level of radon in the homes. Thus the radon level varied from 50 Bq/m³ to more than 3000 Bq/m³. The studies include only women that lived in these homes for 25 years.

Most of the women were non-smokers (only 22 % smokers). It can be mentioned that the self-reported smoking behaviour of the women are made at time of diagnosis. Consequently, the data may be biased due to an obvious tendency to repress and minimise their smoking habit.

Only those with low mobility are included.

The radon level is measured by track-dosimeters for several years. The data could vary significantly through the year as shown in the figure. Along the abscissa is given weeks through the year.

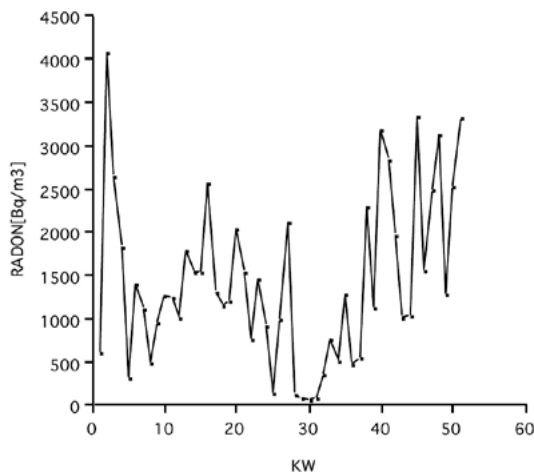

It was assumed that the time spend inside the homes are 68 % of the total. Furthermore the equilibrium factor was set to 0.4.

A number of cases were found not to fit the requirements and are therefore omitted.

It was 4 controls for each case.

The results are given in several tables and given in the figure on the next page.

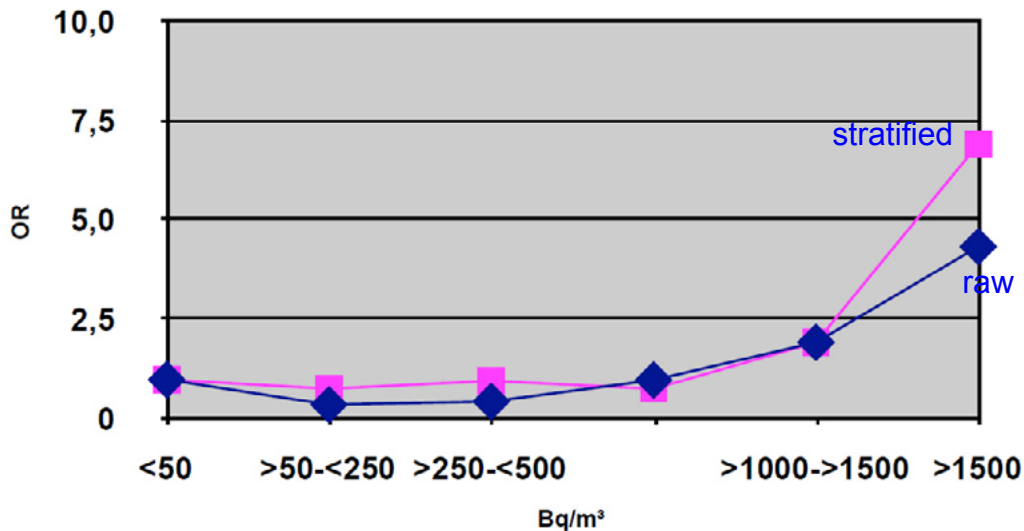

The reference is the group with a radon level below 50 Bq/m³. It is clear that these data do not follow an increase of about 10 % per 100 Bq/m³ as found for Darbu and Krewskis studies. Only for values above 1000 Bq/m³ the risk seems to increase.

The risk estimation of the Schneeberg study for lung cancer from indoor radon is not in accordance with the results from miners and population studies by Darbu and Krewski, which state an excess risk of about 10% per 100 Bq/m³ radon exposure. If such risk estimates are true, in the highly exposed population of Schneeberg such lung cancer risks must have been easily established. That is not the case. From the risk estimate of the Schneeberg study even a safe threshold value was found and a significantly elevated risk appeared at >1.500 Bq/m³ only.

It was not the purpose of this study to test the LNT model. However, the evidence of the Schneeberg study strongly indicates that its results are not in accordance with the LNT assumption. The risk estimations for lung cancer due to indoor radon exposure are derived by direct observation in a key population for such research. The Schneeberg study is considered by its authors as a contribution to the growing body of scientific evidence that the LNT model might not be valid in the low dose range.

Summary of the case-control studies

Thompsons study and the Schneeberg study strongly indicates that its results are not in accordance with the LNT assumption. In the Schneeberg studies an increase in risk was observed only for a radon level above 1000 Bq/m³.

If we assume you are exposed to a radon level of 1000 Bq/m³ for a full year (68 % of the time and an equilibrium factor of 0.5), it would correspond to about 5 WLM. The accumulated dose for 25 years would be of the order 125 WLM. Consequently, the threshold dose for radon in houses would be quite equal to the threshold dose for miners. Furthermore, the external γ -radiation and the dog α -particle radiation both exhibited threshold lung doses of about 0.7 to 1.0 Gy.

Bernhard Cohens ecological studies

The last epidemiological study to be presented is the ecological study by Bernhard L. Cohen (1995 and 2000). This study involve more persons that all the other studies combined, and involve about 90 % of the US population and about 330 000 radon measurements. In this study Cohen divided the country in 1729 counties or regions. The average radon level within each region was determined and compared to the incidence of lung cancer. No control groups, no assumptions on the cleaning system. It is an average for each county. The main results of these studies are given in the figure below.

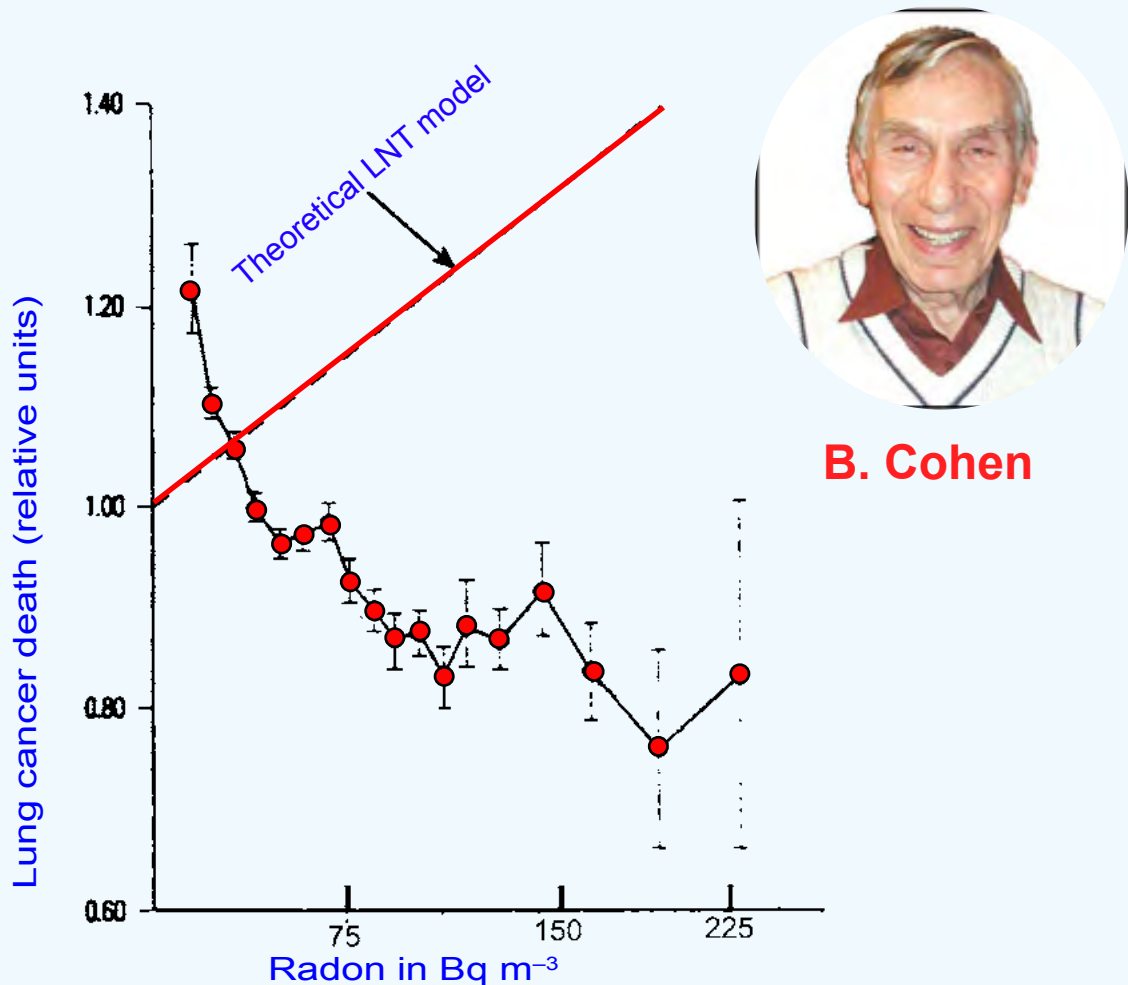

The figure shows the main results of Bernhard L. Cohens investigations from 1995 and 2000 . The main data are published in Health Physics 68 (2), 157 – 174 (1995).

The data points from counties with almost the same radon level have been grouped together.

The data from 2000 include more recent cancer data. Furthermore, data for Florida and California have been deleted because deaths there are frequently due to retirees who received their radon doses elsewhere. The results are however, not changed but are more or less equal to those presented above.

Radon summary

We know that radiation can give cancer. The cancer formation depend on both radiation dose and dose-rate. We have no information about cancer formation for doses below 500 mGy. Furthermore, we have no information about any differences between low and high LET radiation.

On the pages above we have given some of the many epidemiological studies presented about radon as a factor for lung cancer. It is of course not radon itself, but the ionizing radiation from the radon daughters that are able to get into the lungs – the aerosol particles with radon daughters that is not cleaned out again.

We have pointed out the problems connected to case-control studies with regard to dose determination. All studies include a discussion on smoking and smoking is an important factor for the cleaning system. We have little information about other factors that may damage this system – but assume that diesel fumes and nitric oxides are important. May be age is a factor.

A combined result of the studies are: for radon levels up to about 400 – 500 Bq/m³ we can not observe any increase in lung cancer incidence. The combined data on radiation and lung cancer indicate a threshold level of about 0.6 – 1.0 Gy.

The data can not be associated with the LNT-hypothesis. This interesting question will be further discussed in chapters 12 and 13 when we discuss the mechanisms for cancer including all the defense mechanisms.

Radon regulations

ICRP (*International Committee on Radiation Protection*) as well as radiation authorities in most countries use the LNT-theory for the deleterious effect of ionizing radiation. With regard to radon this implies that S. Darbus data are considered valid and the other studies are disregarded. EPA (United States Environmental Protection Agency) is also using the LNT-theory and based on the BEIR VI report assumes that radon in US-homes is responsible for about 20 000 lung cancer deaths per year (between 6 000 and 30 000).

In USA they have introduced regulations for the radon level in houses. For schools and public buildings the radon level should be below 4 pCi per liter which is 148 Bqm⁻³.

WHO assume LNT and use the data from Darbu, Krewski and Lubin. In Norway the radiation authorities have decided to use Darbus data and neglect all other information. Thus they state that the level should be below 200 Bqm⁻³, and it should be possible to introduce remedial action for the site of the building if and when the radon concentrations in the inside air is above 100 Bqm⁻³.

The other European countries the remedial action level is suggested to be 400 Bq/m³ for old houses and 200 Bq/m³ for new houses. In general, it is possible to reach a set level, but the cost may be very large. In the particular case of lung cancer it is more wise to give the money to actions against smoking – and in particular to stop young people from beginning.

The costs for remedial actions for existing dwellings within OECD countries above the action level of 400 Bq/m³ have to be more than 10 Billion ECU. As long as Public Health effects are dubious, no new regulations should be imposed on the public causing billions of ECU without a certain Public Health effect.

Summary

In this chapter we have presented the four main natural radiation sources which are responsible for the natural background radiation. We are exposed to this radiation from the time of conception until we die.

The annual background dose vary from place to place as well as with lifestyle. It is of interest to get more information about the health situation in the areas with high background radiation.

The most discussed source is radon, which exhibits a variation from 10 – 60 000 Bqm⁻³ in the homes. Another important aspect of the radiation emitted by radon is that a large fraction consists of α -particles. The α -particles result in high density of ionizations along the track (high LET radiation). ICRP and the radiation authorities give this radiation a large radiation weight factor. We meet the high LET radiation only in the case of radon. The results presented above with lung cancer induction by low LET radiation and the dog experiments with high LET radiation are in fact very equal. Both dataset involve a dose limit of about 1 Gy for low LET and about 0.6 Gy for high LET. This suggests a radiation weight factor for α -particles of about 2! It is of interest to note that this is more in line with the weight factors observed for cell-killing.

Members of the public often seem to ignore the natural doses of radiation, whereas they are very concerned about smaller doses from anthropogenetic sources such as nuclear accidents (Windscale, Three Mile Island, Chernobyl, Fukushima, etc.) and radioactive waste products from the nuclear industry.

With regard to health effects from the natural radiation sources we have introduced two opposite models. According to the LNT hypothesis all dose levels are harmful to the society – whereas the other model suggests some beneficial effect from the radiation.

According to newer biological research (including defense mechanisms such as stimulated repair and apoptosis) the natural radiation is positive with regard to health and may save life. This will be discussed in a later chapter.

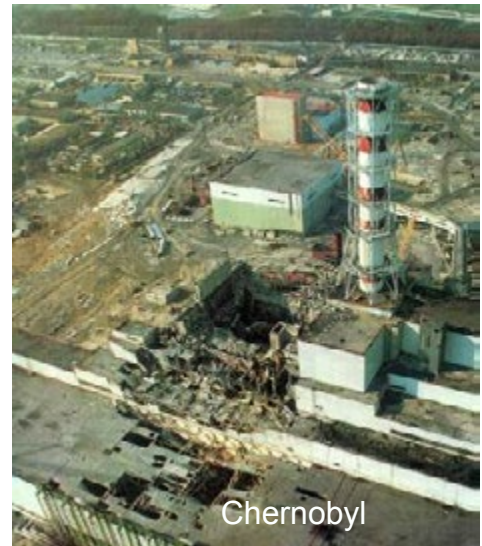

- The two main sources for man-made radioactive pollution are:
1. Nuclear bomb tests in the period 1945 to 1999.
 2. Reactor accidents – in particular Chernobyl in April 1986.

Chapter 8

Nuclear Weapons – Reactor Accidents and Pollution

This chapter is concerned with radioactive pollution, nuclear weapon tests and reactor accidents that have occurred over the years. The doses to the general public, are mostly small (smaller than those from natural radiation), whereas doses to particular groups may be significant.

In this chapter we shall give a brief review of the physics involved in the development of reactors and atomic bombs – as well as the radioactive pollution from the bomb tests and the reactor accident in Chernobyl.

Reactors and Nuclear Bombs

In Chapter 4 we described the research during the 1930th that resulted in the discovery of fission in December 1938. In January 1939 Bohr embarked on a four month stay in the United States as a visiting professor and he brought the exciting news about fission to the U.S. The development from that point was quite rapid. Thus, already in December 1942 the first nuclear reactor was started by Fermi in Chicago – and July 16, 1945 the first atomic bomb exploded near Almagordo in New Mexico.

In the following we shall try to give some of the highlights from this research.

The fission reactor

N. Bohr and J. A. Wheeler found that it was U-235 that was the fissile isotope (only 0.71 % of uranium consists of this isotope). The main uranium isotope U-238 is not fissile, but can be fissionable when hit by an energetic neutron with an energy above 1 MeV. Otherwise U-238 is transformed into plutonium Pu-239 which in turn is fissile.

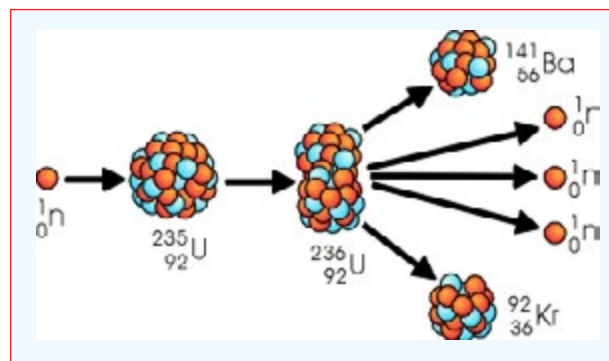

Leo Szilard
(1898 – 1964)

The Hungarian physicist Leo Szilard had the idea about a chain reaction. As you see in the illustration the fission process releases neutrons, that in turn can be used to fission other U-235 atoms – and thus give a chain reaction.

The neutrons released in the fission process have an energy of about 1 MeV – and the "cross section" (the chance for a reaction) for neutron capture leading to fission is greatest for neutrons with an energy around 1 eV, a million times less (so-called "thermal neutrons"). It is therefore necessary to slow down the neutrons for efficient operation of a nuclear reactor, a process called moderation. In a reactor it is necessary to mix in a moderator with the uranium core. A moderator consists of light atoms (preferably close to the weight of the neutron).

In ordinary water, the hydrogen atom has the right weight, but readily absorbs neutrons. Heavy water, containing deuterium is also a useful moderator and is used in certain reactors. On page 14 we have mentioned that the heavy water production at Vemork played a role during the second world war since Norway was the only producer of heavy water.

It was E. Fermi and coworkers that built the very first reactor in a squash court at Stagg stadium in Chicago. They used graphite as moderator and the reactor was constructed by layers of graphite. In the layers they left room for boxes of natural uranium (about 2.5 kg in each box). They had 10 control rods, made of cadmium which could absorb and control the neutrons.

If fission, on average, gave one neutron that could split a new atom, the process would go by itself. This *reproduction factor*, as Fermi called it, must be larger than 1.0. They measured the neutron flux all the time.

The construction had the form of an ellipsoid (like an egg), 7.6 meters wide and about 6 meters high. It had 57 layers of graphite (385 tons) and about 40 tons of uranium oxide.

December 2, 1942 was a cold day with snow in Chicago. It was the day for the first attempt to start a reactor – and the atmosphere at Stagg stadium was intense. Several people were gathered on the balcony where the counters were located (among them Szilard, Wigner and Compton). Fermi gave the order to slowly remove the control rods and the neutron flux (measured by boron-trifluoride counters) increased. Finally he asked to take the last control rod 12 feet out. The clicking of the counters increased to a continuous roar. Fermi raised his hand and said; "*The pile has gone critical*". The reproduction value had been 1.0006. The first day the reactor operated for 4 minutes at an intensity of half a watt.

We can note that Fermi used ordinary uranium (with only 0.71 % of U-235). They noticed that the reactor produced tiny quantities of plutonium Pu-239. The plutonium was formed in the reactor from U-238 in the following way:

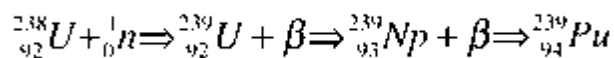

U-238 absorbs the neutron. U-239 is unstable and emit a β -particle with a half-life of 24 minutes. Np-239 is also unstable, emits another β -particle (half-life 2.3 days) and the fissile isotope Pu-239 is formed. This compound can be used as fuel in a reactor and also as the explosive in a fission bomb. Consequently, a reactor was built in Oak Ridge in 1943 and furthermore three large-scale reactors were built for that purpose at Hanford in Washington, USA in 1945.

After the war a number of reactors have been built – both for power production as well as for research. We can mention that a research reactor was built at Kjeller, Norway which was opened in July 1951.

It is not our purpose to describe the different power reactors used (approximately 450), but we would like to mention a few points. The reactors are based on thermal neutrons, and are divided into two groups; namely gas-cooled/graphite-moderated reactors and water-cooled/water-moderated reactors (light water reactors). In addition, there are reactor types between these categories; for example, the Russian water-cooled/graphite-moderated reactor (the so-called Chernobyl type). There are also heavy water moderated reactors.

The reactors account for 14 % (2011) of the electric power in the world. They do not release greenhouse gases and should therefore represent an excellent alternative for energy production. Two arguments have been raised against nuclear power:

1. Reactor accidents.
2. Radioactive waste

The type of waste that give the problems consists of long-lived radioisotopes and comes from used fuel that is not reprocessed or from components separated in the reprocessing. The waste may be in the liquid or glassified form and the activity is high enough to produce heat. The glassified waste contains more than 99% of the total activity that was present before treatment. The main goal of treatment and storage of radioactive waste is to bring the radioactivity into a form which is suitable for permanent storage.

Reactor accidents has occurred and efforts have been made with regard to design and to make reactors more safe. It is a primary goal to prevent damage to the reactor core. The safety regulations have to be organized as a "*defense in depth*". If an accident should occur, the defense system should be able to reduce the consequences and prevent the release of radioactivity.

The energy involved in fission and fusion

Protons and neutrons are kept together by strong forces in the atomic nucleus. In the figure below we have given the binding energy for the different atoms. This figure is important with regard to the energy involved in both fission and fusion.

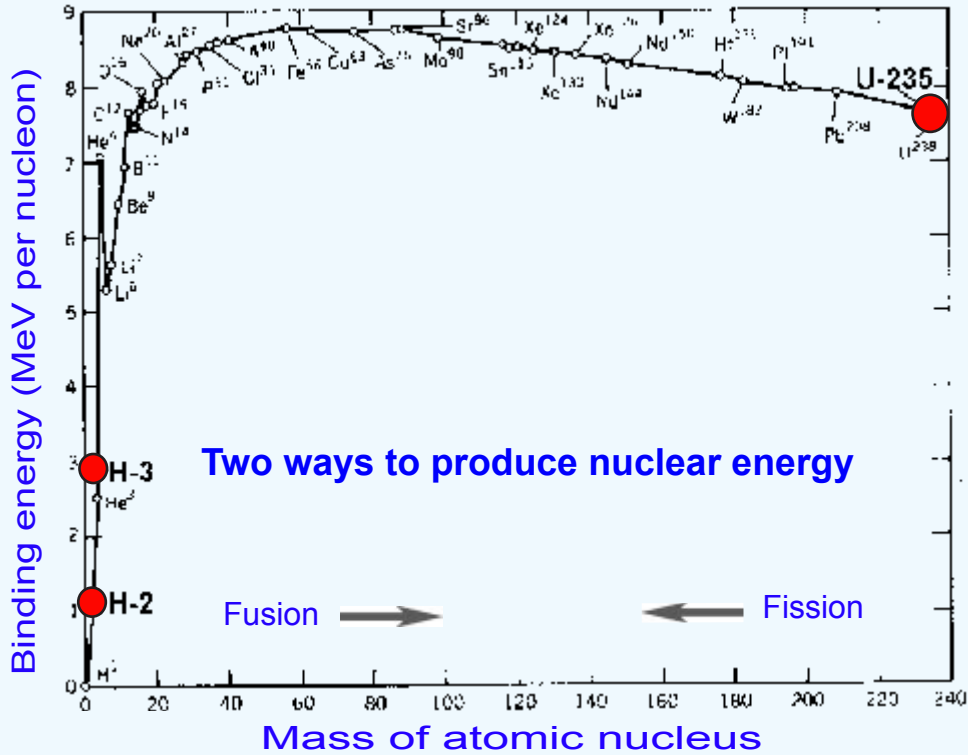

The mass (in number of nucleons) of the nucleus is given along the abscissa. Along the vertical axis is given the binding energy per nucleon (mass unit). Deuterium has a binding energy of 1.1 MeV – or 2.2 MeV for the two particles that makes up the deuterium nucleus. The binding energy for He-4 is 7 MeV – i.e. 28 MeV for the 4 nucleons together.

Fission

You see from the figure that it is possible to gain energy by transforming a nucleus with a small binding energy to another with a larger binding energy. Thus, upon a fission of uranium into two almost equal parts the gain is approximately 1 MeV per nucleon (about 235 MeV for one fission). About 25 MeV is in the form of γ -rays and about 5 MeV in kinetic energy of the neutrons released. This implies that in a fission bomb the explosion is followed by a burst of γ -rays and fast neutrons.

Fusion

The other possibility to gain energy is in a fusion process. The requirement is that light atoms with a low binding energy are used. The hydrogen isotopes, deuterium and tritium can be used for fusion and we can give three possible processes.

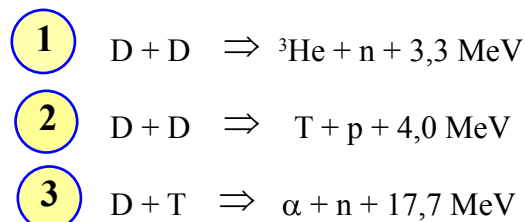

D = H-2
T = H-3
 α = He-4

Deuterium is a stable isotope and can easily be produced. However, the two first processes requires a start temperature of about 100 million degrees. For reaction 3 the temperature should be about 40 million degrees. If deuterium and tritium can be brought together with such energies a fusion reaction may take place. In a fusion bomb this has been a reality by using a fission bomb to ignite the reaction. Fusion, both for energy production (controlled) and for bombs requires tritium as fuel. Tritium can be formed by bombarding the light Li-isotope (Li-6) with neutrons in a reactor:



Lithium consists of two isotopes; Li-6 (7.4 %) and Li-7 (92.6 %). The compound LiD (lithiumdeuteride) has been used for fusion bombs with the assumption that it was only Li-6 that contributed to the tritium production. It came therefore as a surprise when it was discovered that also Li-7 give tritium when bombarded with fast neutrons according the reaction:



The latter process can increase the yield of fusion bombs – which was discovered in the US test bomb "Castle Bravo" in the Bikini atoll in 1954.

Critical mass

An important concept for fission bombs is the critical mass. When the fuel is below critical mass, there aren't quite enough nuclei around to keep the chain reaction going and it gradually dies away.

When the fuel is above critical mass, there are more than enough nuclei around to sustain the chain reactions. In fact, the chain reaction grows exponentially with time – and we have an explosion.

The size of the critical mass depends on shape, density, and even the objects surrounding the nuclear fuel. Anything that makes the nuclear fuel more efficient at using its neutrons to induce fissions helps that fuel approach critical mass. The characteristics of the materials also play a role. For example, fissioning plutonium 239 nuclei release more neutrons on average than fissioning uranium 235 nuclei. As a result, plutonium 239 is better at sustaining a chain reaction than uranium 235 and critical masses of plutonium 239 are typically smaller than for uranium 235. By using a neutron reflector, about 4 – 5 kilograms of Pu-239 or about 15 kilograms of U-235 is needed to achieve critical mass.

In an atomic bomb, a mass of fissile material, greater than the critical mass, must be assembled instantaneously and held together for about a millionth of a second to permit the chain reaction to propagate before the bomb explodes

During the war the "Manhattan project" included the most competent physicists in the world with the purpose to construct a fission bomb. A laboratory was built in Los Alamos, New Mexico, in late 1944. On the lava flows of an extinct volcano 35 miles north of Santa Fe, Robert Oppenheimer, a brilliant physicist from the University of California, led the development of the first nuclear fission weapons. The fissionable materials, solid uranium tetrafluoride from Oak Ridge and plutonium nitrate paste from Hanford, began to arrive at a Los Alamos, and chemists purified the two metals and metallurgists shaped them into forms suitable for the weapons. Two possible mechanisms were worked out in order to bring the fissile material together and reach critical mass or above. In the "*gun method*" two subcritical masses were brought together and in the "*implosion method*" the fissile material formed in a hollow sphere were forced together.

In July 1945 they had enough fissile materials for three bombs. The first one was a plutonium bomb and the implosion method was used. The test was performed in the desert south of Los Alamos. The test was successful and then the "go signal" was given for the two other bombs that hit Hiroshima and Nagasaki on August 6. and 9. 1945.

Some of the details for the two bombs in Japan in 1945

The bombs exploded 550 – 600 meters above ground. The explosions released a large amount of energy. The energy takes three forms: 1) Heat, 2). Blast or pressure and 3). Radiation.

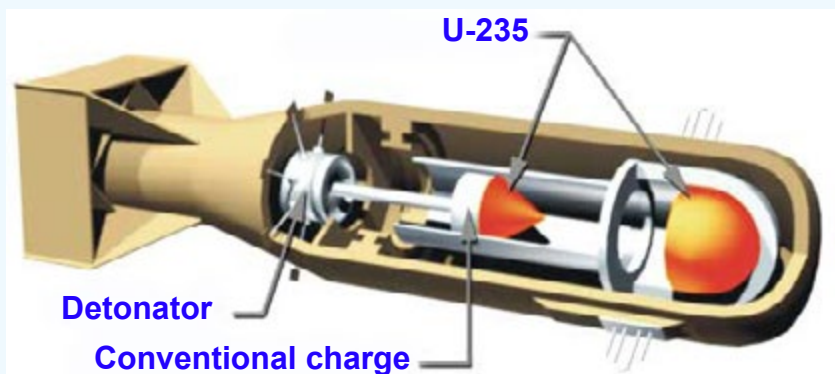

Hiroshima bomb "Little boy" Gun type

67 kg with 90 % enriched U-235. About 1 kg fissioned
Yield equivalent to 15 – 20 kton TNT.
The explosion caused about 100 000 immediate deaths.

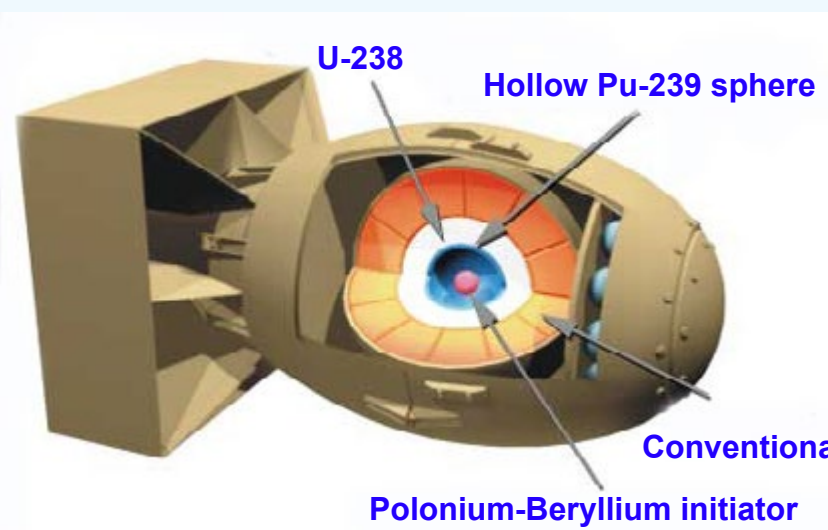

Nagasaki bomb "Fatman" Implosion type

6.4 kg of Pu-239.
Yield equivalent to 21 kton TNT.
About 40 000 immediate deaths.

Radiation doses

About 25 MeV of each fission go into γ -radiation – and about 5 MeV into neutrons. Consequently, the explosion is followed by a burst of radiation. Thousands of hours have been spent in order to calculate the doses involved in the burst. The most extensive dosimetry system was carried out in 1986 (DS86). Doses have been calculated – with information about shielding to 86 600 survivors. We shall return to this group in a later section.

"Free in air doses" have been calculated as a function of distance from the hypocenter. The γ -doses are much larger than the neutron doses. For distances within 1000 meter the doses reach values of more than 5 Gy. At such distances the radiation would be lethal. However, all persons within this distance would be killed by the heat and pressure wave. Consequently, radiation is not the most serious threat of the bombs.

The men behind the projects leading to the atomic bombs

A large number of the physicists during world war II and the years after the war contributed to the development of the nuclear bombs. Below we have given the leading scientists in USA and the Soviet Union.



Robert Oppenheimer
(1904 – 1967)

Robert Oppenheimer was the leader of the Los Alamos laboratory – and this group developed the bombs used in Hiroshima and Nagasaki.

In Soviet Union they embarked on a bomb project in 1945 based on valuable information attained via spies (Klaus Fuchs). Igor Kurchatov and his group made the first test in Kazakhstan in August 1949 (plutonium fission).

Igor Kurchatov
(1903 – 1960)



Scientists like Edvard Teller worked for the development of fusion bombs with much higher power. The bombs developed consist of a combination of fission and fusion. A fission was needed to create the high temperatures needed for the fusion. The first man-made fusion explosion took place in November 1952 in the Eniwetok atoll in the Pacific. The bomb or rather the device (because it was so big and heavy – weighing 82 ton) was build up on the small island Elugelap. The explosion which vaporized the island, was estimated to about 10 megaton TNT and resulted in a large fallout. You can see a video of the experiment. Go to the address:
<http://www.archive.org/details/OperationIVY1952>



Edvard Teller
(1908 –2003)



Andrei Sakharov
(1921 – 1989)

In the Soviet Union Andrei Sakharov developed the hydrogen bomb – and the first one tested in November 1955. The largest bomb ever, called "Tzar Bomba", was of the same type and is estimated to about 50 Mton TNT It exploded October 30, 1961, in Novaya Zemlya.

The fallout from the bomb tests was observed at the University of Oslo. The first wave of radioactive products used 4 days to travel the distance from Novaya Zemlya to Oslo – 2000 km.

Nuclear bomb tests

During the period from July 1945 up to present, 543 nuclear bombs have exploded in the atmosphere. Furthermore, 1866 underground tests have been performed. The total energy in these tests has been calculated to be equivalent of about 530 megatons of TNT. The nuclear tests were particularly frequent in the two periods from 1954 to 1958 and from 1961 to 1962.

Several nuclear tests were performed in the lower atmosphere. When a blast takes place on the ground or in the atmosphere near the ground, large amounts of activation products are formed from surface materials. The fallout is particularly significant in the neighborhood of the test site. One of the best known tests with significant fallout took place at the Bikini atoll in the Pacific in 1954 (see the "Castle Bravo" test below).

The first fission test was the one in New Mexico on July 16, 1945 – and the first fusion test took place at the Eniwetok atoll in the Marshall Islands on November 1, in 1952 (the Mike test).

The largest nuclear weapon ever tested was the "Tsar Bomba" of the Soviet Union at Novaya Zemlya on October 30, 1961, with an estimated yield of around 57 megatons. The fallout from this explosion as well as the other atmospheric tests at Novaya Zemlya was considerable for Scandinavia. We shall give you some of the fallout measurements carried out in Oslo by Anders Storruste and his students.

An illustration of the power (energy released) for some of the best known nuclear bombs and tests



The size of the mushroom indicate the size of the bomb.

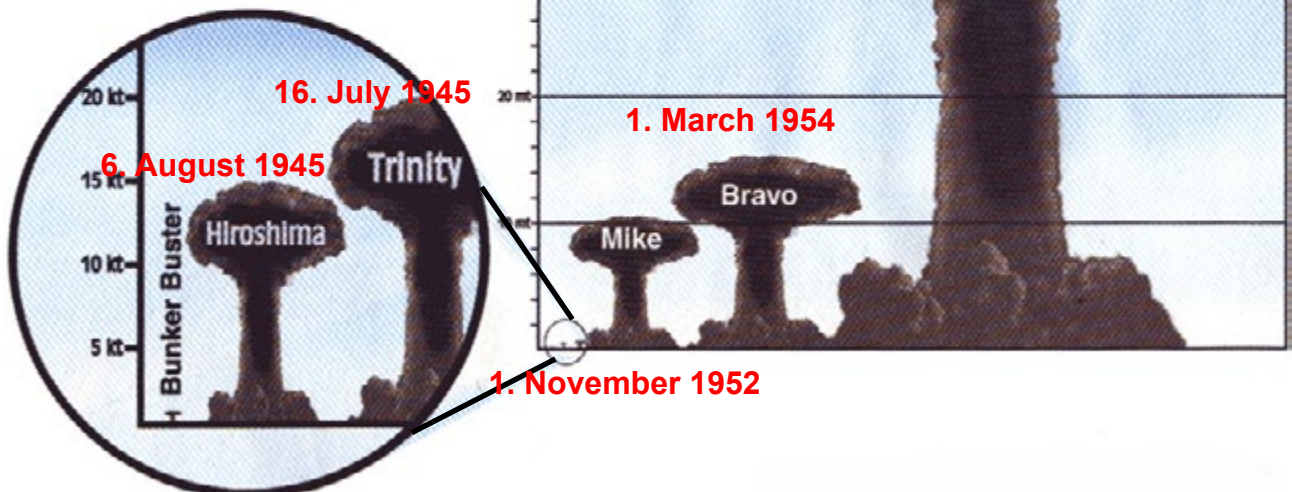

Nuclear weapon tests sites

The first nuclear bomb test took place near Almagordo in New Mexico (marked 9 in the map) in July of 1945. Since then, the United States, the Soviet Union, England, France, China, India, Pakistan and Korea have tested the weapons in the air, on the ground and underground. The map below shows most of the places used for these nuclear tests.

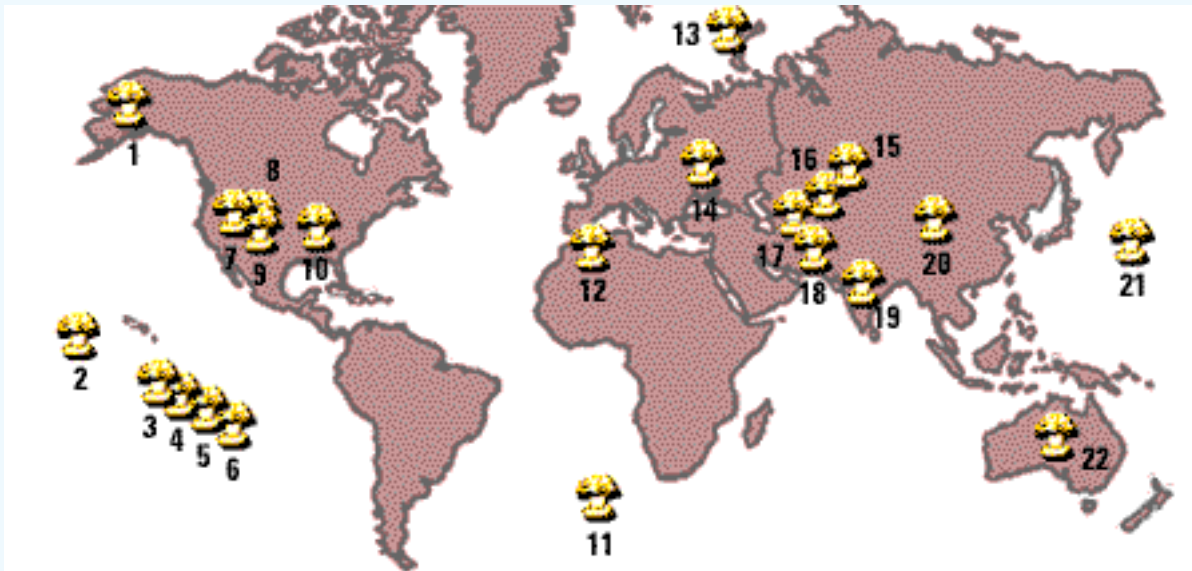

The following test sites are marked in the map: 1. Alaska (US) -- 3 Tests, 2. Johnston Island (US) -- 12 tests, 3. Christmas Island (UK & US) -- 30 tests, 4. Malden Island (UK) -- 3 tests, 5. Fangataufa Atoll (France) -- 12 tests, 6. Mururoa Atoll (France) -- 175 tests, 7. Nevada (US) -- 935 tests, 8. Colorado (US) -- 2 tests, 9. New Mexico (US) -- 2 tests, 10. Mississippi (US) -- 2 tests, 11. South Atlantic Ocean (US) -- 12 tests, 12. Algeria (France) -- 17 tests, 13. Russia (USSR) -- 214 tests (many at Novaya Zemlya), 14. Ukraine (USSR) -- 2 tests, 15. Kazakhstan (USSR) -- 496 tests, 16. Uzbekistan (USSR) -- 2 tests, 17. Turkmenistan (USSR) -- 1 test, 18. Pakistan (Pakistan) -- 2 tests, 19. India (India) -- 4 tests, 20. Lop Nur (China) -- 41 tests, 21. Marshall Islands (US) -- 66 tests, 22. Australia (UK) -- 12 tests

The "fallout" of radioactive isotopes from the bomb tests, depends on the type of bomb and, most of all, whether the bomb is detonated in the air, on the ground or underground. The fallout of radioactive isotopes is due to the atmospheric tests.

Furthermore, if the explosions take place at altitudes where the so called "fire ball" reach the ground a large amount of radioactive isotopes may be formed.

For the atmospheric nuclear tests a considerable amount of radioactivity reach the stratosphere. Due to the low exchange between the troposphere and stratosphere these isotopes may stay for a long time in the stratosphere.

The radiation doses to the public from all these nuclear tests have been very small. They cannot be measured against the natural background doses. The exceptions are a few atmospheric tests performed in the early years.

A particular US test – Castle Bravo

On March 1, 1954, the United States detonated a hydrogen bomb (with a power of about 15 million tons of TNT) at the Bikini-atoll in the Pacific (see map below). The device was a large cylinder weighing 10.7 tons and measuring 4.56 m in length and 1.37 m in width. It was mounted in a "shot cab" on an artificial island built on a reef off Namu Island, in the Bikini Atoll.

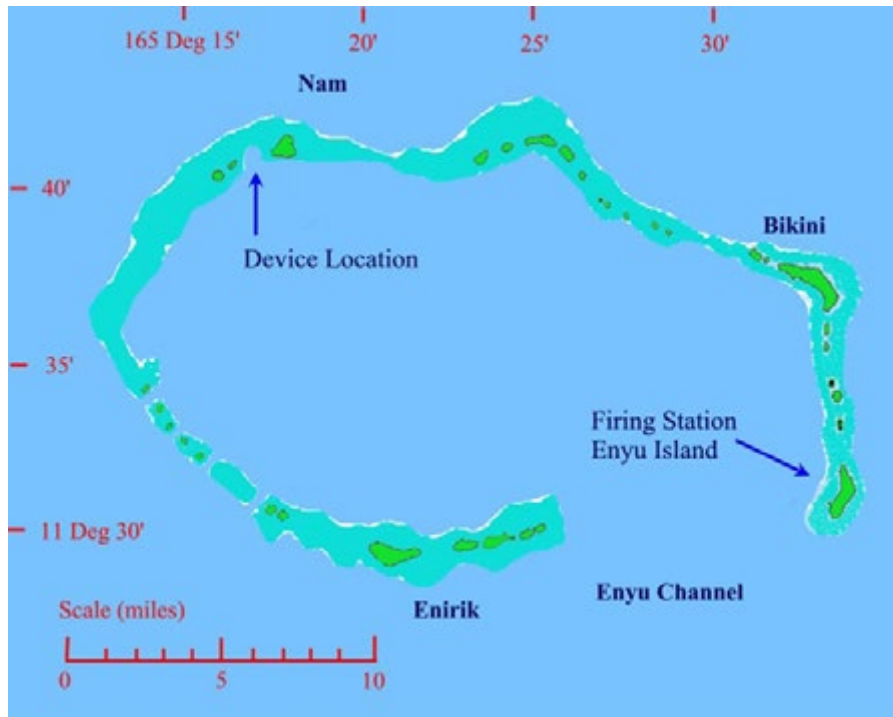

On page 111 this test site is marked as 21. The firing station was about 20 miles (32 km) away. It was a solid bunker and the crew was protected from the blast as well as the radiation.

The bomb with the code name "Castle Bravo" was estimated to have a power of about 5 Mton TNT – however, turned out to be about 3 times larger. Let us try to explain this.

The fuel consisted of 37 - 40% enriched lithium-6 deuteride encased in a natural uranium tamper. It was expected that the lithium-6 isotope would absorb a neutron from the fission of plutonium, – emit an alpha particle and tritium in the process. Then tritium would fuse with deuterium (which was already present in the LiD) and consequently increase the yield in a predicted manner.

The designers missed the fact that when the lithium-7 isotope (which was considered basically inert) was bombarded with high-energy neutrons, the reaction outlined on page 107 was possible. This means that much more tritium was produced than expected, and this increased the fusion. The extra neutron from the lithium-7 decomposition resulted in more neutrons than expected, – with the result that more fission was induced in the uranium surroundings. Since both lithium-6 and lithium-7 contributed greatly to the fusion reactions and the neutron production – which in turn resulted in more fission, the yield increased dramatically.

When Bravo was detonated, it formed a mushroom roughly 7 km across within a second. This fireball was visible on the Kwajalein atoll 450 km away. The explosion left a crater of 2,000 m in diameter and 75 m in depth. The mushroom cloud reached a height of 14 km and a diameter of 11 km in about a minute; it then reached a height of 40 km and 100 km in diameter in less than 10 minutes.



Castle Bravo

Since the explosion took place only 2 meter above ground considerable amounts of material (such as coral) were sucked up into the fireball and large amounts of activation products were formed. Castle Bravo was really a "dirty bomb".

A couple of hours after the blast, the instruments on the American weather station on Rongerik island (about 212 km away) indicated a high radiation level and the crew was evacuated the day after. Evacuations of the 154 Marshallese Islanders only 160 km from the shot did not begin until the morning of 3 March. The islanders received a whole-body radiation doses of about 1.7 Gy on Rongelap, 0.7 Gy on Ailinginae, and 0.14 Gy on Utirik.

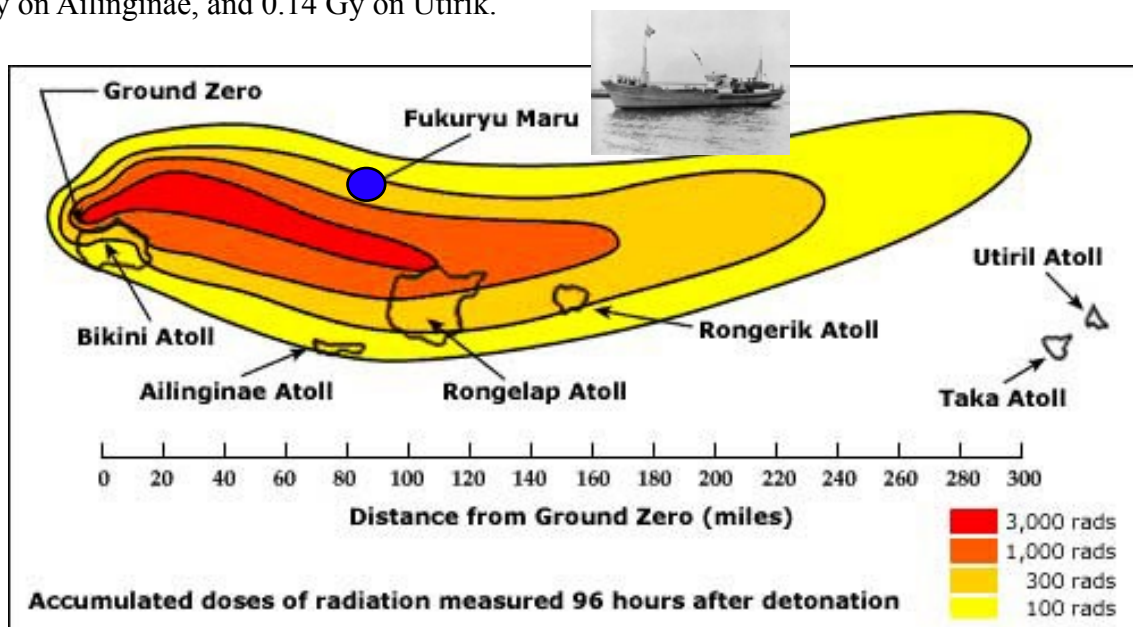

Above is a dosemap that gives the accumulated dose 4 days after detonation. If you stayed outside during the 4 days you would attain that dose. The dose is given in rads – and remember that 1 Gy = 100 rads. The position of Fukuryu Maru at the blast is indicated.

Because the fallout for these islands was so large, the inhabitants were not allowed to live there for 3 years. A lot of work has been done with cleaning up the islands – and they were declared safe for habitation in 1980.

Fukuryu Maru

Approximately 130 km from the Bravo test-site was the Japanese fishing boat "Daigo Fukuryū Maru" with 23 fishermen aboard. After the blast they pulled in the fishing equipment and sailed away. Within hours the fallout started in the area where the boat had moved.

Dust, soot and even larger particles came down. The crew lived with this for a number of days and took no special precautions with regard to hygiene, food, and clothing since they had practically no knowledge of radioactivity and its biological effects.

The fishermen received very large doses, calculated to be about 3 Gy. They felt nauseous and received skin burns from β -particles in the fallout. One of the fishermen died of a liver disorder within 6 months. It may be that it was a result of the radiation.

Most of the fishermen were still alive 30 years later. Chromosome analyses showed larger amounts of damage than normal in their lymphocytes.



This is a picture of Fukuryu Maru which now is on exhibition in Tokyo.

In general

Because of the extreme temperature of a nuclear explosion, the radioactive material becomes finely distributed in the atmosphere. A certain fraction is kept in the troposphere (the lower 10 km) and is carried by the wind systems almost at the same latitude as the explosion. This part of the radioactive release will gradually fall out, the average time in the atmosphere being about one month.

The main fraction of the radioactive debris from an atmospheric test goes up into the stratosphere (10 to 50 km). This fraction can remain in the stratosphere for years since there is a very slow exchange between the troposphere and the stratosphere. The fallout consists of several hundred radioactive isotopes; however, only a few give significant doses. The most important are the following:

- **Zirconium-95** (Zr-95) has a half-life of 64 days and **iodine-131** (I-131) has a half-life of 8 days. Both of these isotopes, in particular I-131, are of concern for a short period (a few weeks) after being released to the atmosphere. This isotope was important in the Chernobyl accident.
- **Cesium-137** (Cs-137) has a half-life of 30 years. The decay scheme for this isotope (see page 17) shows that both β -particles and γ -rays are emitted. The β -emission has an impact on health when the isotope is in the body or on the skin. The γ -radiation has an impact both as an internal and external radiation source.

- **Strontium-90** (Sr-90) has a half-life of 29.12 years. This isotope emits only a β -particle and is difficult to observe (maximum energy of 0.54 MeV). This isotope is a bone seeker and is important when the isotope enters the body. It should be noted that Sr-90 has a radioactive decay product, Y-90, which has a half-life of 64 hours and emits β -particles with a maximum energy of 2.27 MeV. With this short half-life, it is likely that this amount of β -energy will be deposited in the same location as that from Sr-90.
- **Carbon-14** (C-14), while not a direct product of fission, is formed in the atmosphere as an indirect product. The fission process releases neutrons that interact with nitrogen in the atmosphere and, under the right conditions, C-14 is formed as an activation product. The individual doses from this isotope are extremely small. However, due to the long half-life of 5730 years, it will persist for many years. When C-14 is used in archeological dating, it is necessary to correct for the contribution from the nuclear tests.

Nuclear tests at Novaja Zemlja in 1961 and 1962

The nuclear tests of most concern for the Northern Hemisphere were performed by the former USSR (Russia) on the island Novaja Zemlja located in the Arctic, approximately 1,000 km from northern Norway. When these islands were chosen as a test site in 1954, more than 100 families lived there. They were all removed from their homes. Altogether 87 atmospheric nuclear tests were performed at this site. The activity was particularly large during 1961 and in the fall of 1962. Most of the tests were performed at high altitudes, thus the "fireball" did not reach the ground. Consequently, the production of activation products was limited.

We shall give some of the results of the measurements carried out in the 1960-ties



The fallout after the tests at Novaja Zemlja was largely determined by precipitation. It was quite large on the western part of Norway. The isotopes Cs-137 and Sr-90 entered the food-chain via grass (in particular reindeer lichen). Consequently, sheep, cows and reindeer ingested radioactive material when feeding on grass and reindeer lichen. People eating the meat or drinking the milk from these animals received some extra radioactivity.

The "Tzar Bomba"

From September 10 to November 4, 1961, the Soviets carried out 20 nuclear tests at Novaja Zemlja. The power of the bombs varied from a few kilotons TNT (equal in power to the Hiroshima bomb) to approximately 57 megatons TNT (the "Tzar Bomba"), which is the largest bomb ever detonated. The "master" of this bomb was Andrei Sakharov. He was given the job by Nikita Khrushchev to construct a 100 Mton bomb. The bomb was considered to be a combination of fusion and fission. A small fission bomb should ignite the fusion which in turn should yield neutrons to produce more fission in an uranium tamper.

It was decided to replace the uranium tamper with lead. This reduced the yield by 50 % and also the fallout. The bomb was delivered with a plane and dropped from 10 000 m with a parachute. This gave the plane time to go 45 km away when the explosion took place at 4000 m above the west coast of Novaja Zemlja. Due to the construction and the height for the explosion the fallout was small and the bomb was rather clean.



Fallout

The radioactive fission products from all the atmospheric tests were released to the atmosphere. Estimations have been made about the release of fission products. The total release of Cs-137 from all the bomb tests is approximately 30 times larger than that released during the Chernobyl accident. The total release of Sr-90 is calculated to be about 75 times larger than the Chernobyl accident.

As mentioned earlier, when a blast takes place in the atmosphere, a large fraction of the radioactivity will go through the troposphere and into the stratosphere. Since the exchange between the two is rather slow the radioactivity will remain in the stratosphere for a long time. Westerly winds on the Northern Hemisphere will bring the activity to the east. The radioactivity from the nuclear tests in the 1960s was distributed over large areas; however, the amount of fallout varied from one region to another according to the variation in rainfall (most of the fallout came down with the rain).

The fallout pattern from the nuclear tests was different from that of the Chernobyl accident. In Chernobyl the radioactive isotopes were restricted to the troposphere, and was then brought around by the wind. The wind direction was very important for the fallout.

The fallout from the tests at Novaya Zemlja was followed and measured in Norway. We would like to give you some examples of the work carried out – mainly by Anders Storruste and his students at the University of Oslo, about 2000 km from the test site.

Measurements in Oslo

A number of measurements were carried out in order to determine the activity in the air – in the rainwater as well as in the food products. To a large extent scintillation counters were used and the observations were concentrated on the γ -radiation from Cs-137. It is far more difficult to observe Sr-90 since it only emits β -particles. Attempts were made in particular experiments to measure the ratio between Cs-137 and Sr-90. This ratio was assumed to be rather constant implying that the Cs-137 observations also yielded information on Sr-90. In some Austrian measurements of milk the ratio Sr-90/Cs-137 increased slowly from about 0.6 to more than 1.0 in the period 1960 to 1997.

The Cs-137 activity in food products (meat, milk, cheese, etc.) was measured. Furthermore, whole-body measurements were started in order to determine the level of Cs-137. For that purpose particular shielded rooms and equipment were constructed. We shall give you some of the details.

Radioactivity in the air

The radioactive isotopes from the bombs become attached to dust particles in the air and transported with the wind. In order to measure the radioactivity in the air it was used a vacuum cleaner. Thus air containing radioactive dust was sucked through a filter. If the filter was laid directly on an x-ray film and the radioactivity can be observed (see an example below).

The radioactivity on the filter was measured. Since the air volume drawn through the filter was measured, the activity could be calculated in Bq per cubic meter. These experiments were carried out by Ivar Mattingsdal for his master exam in 1963. The data are given in the figure on the next page.

As can be seen from the figure, the activity started to increase on September 14. 1961 (4 days after the first blast at Novaja Zemlja). In October, the air activity 2000 km away from the test site was approximately 30 times larger than normal.

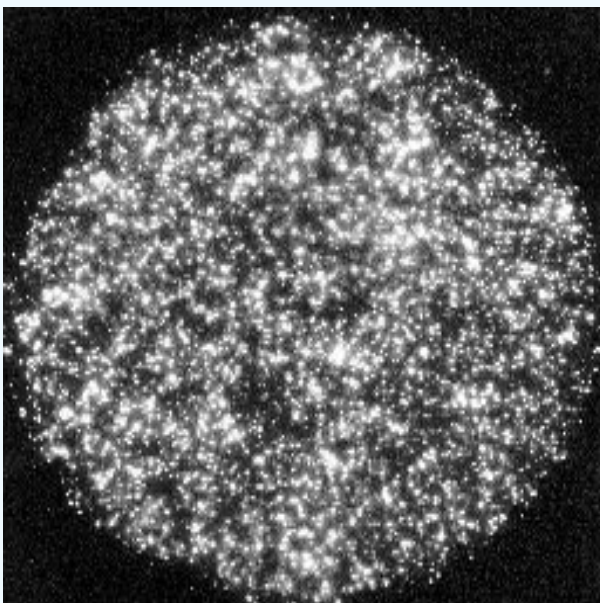

Courtesy of Anders Storruste, Inst. of Physics, Univ. of Oslo

Radioactivity from the bomb tests.

The activity in the air during the nuclear tests at Novaja Zemlja in 1961 was measured by sucking air through filters. The white dots indicate small particles containing radioactive isotopes.

The radioactivity reached Oslo (2000 km away) after 4 days.

The types of isotopes in the filter were measured with a scintillation counter.

The fallout was measured by collecting the rainwater – and then observing the radioactivity.

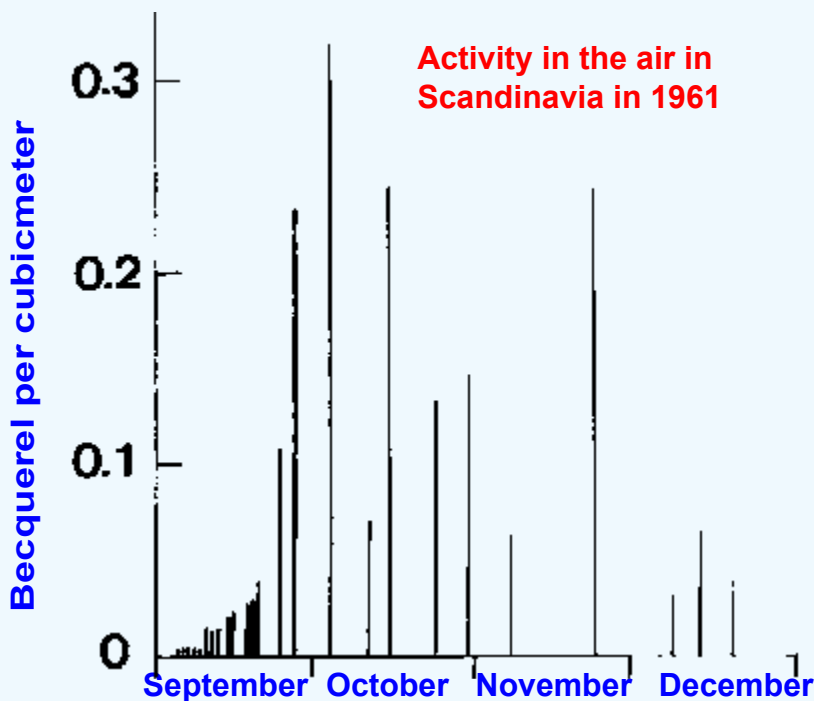

Ivar Mattingsdal

Courtesy of Anders Storruste and Ivar Mattingsdal, Inst. of Physics, Univ. of Oslo

The measurements presented here serve as an example of airborne radioactivity in combination with nuclear tests in the atmosphere. The observations are made in Oslo – 2000 km from the test site on Novaja Zemlja. The activity is given in Bq per cubic meter air. As can be seen, the "Tzar Bomba" on October 30 did not give any peak value in the beginning of November – which confirm that it was a rather clean bomb.

Similar measurements were performed in 1962. On November 7th, the air activity in Oslo was about 200 times above normal, indicating that one of the bombs (classified as middle power) which exploded on November 3 or 4, produced large quantities of fission products.

Radioactivity in the rain water

The fallout is mainly connected to the precipitation. The rain hitting the roof of the Physics building at the University of Oslo was collected. Samples consisting of 2 liter were damped and the activity measured with Geiger-Müller counters.

In the period from September 1961 to November 1962 the total fallout in Oslo was 37 kBq/m². The average activity in the rain water was 35 Bq per liter. It can be mentioned that the fallout in Norway after the Chernobyl accident was on average 7 kBq/m² – however, in certain areas it was about 100 kBq/m².

Radioactivity in food and people

In the years since the bomb tests in the atmosphere were canceled, the amount of radioactive isotopes have continued to diminish. The fallout is dominated by the two isotopes Cs-137 and Sr-90. The fallout has decreased considerably since the mid-1960s but still, more than 40 years later, a small fallout persists from the bomb tests.

The radioactive isotopes hitting the ground become bound to plants, grass and, in particular, reindeer lichen. The activity in this plant decreases more slowly than that for plants withering in the fall.

The radioactive isotopes on the ground slowly diffuse into the soil. Some of them are taken up in plants via the roots. Consequently, a certain fraction of the fallout will find its way into the food chain and finally into humans. The radioactivity in both food products as well as in some humans have been measured and followed for a number of years.

Whole body counting in the 1960-ties

The equipment below was built in connection to the bomttests at Novaya Zemlja. Kjell Madshus built the counter at "The Norwegian Radium Hospital" and measured a number of Lapplanders which used a lot of reindeer meet.

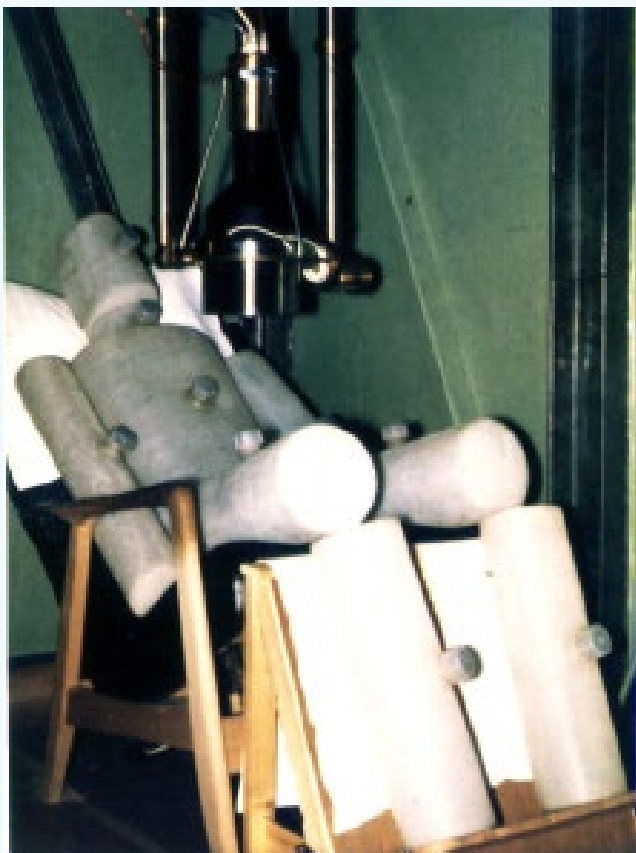

In the picture you see a phantom and the scintillation counter.

A large NaI (TI) crystal (diameter 20 cm and height 10 cm) – coupled to 3 photomultipliers was used. The counter was pointing towards the middle section of the person (phantom in the picture).

The room had concrete walls covered with steel plates to reduce the background radiation. The air was filtered to reduce the effect of radon and daughter products.

The screening of the room had a weight of 40 ton – the door into the room weighed 3.5 ton!

Calibration was carried out by using the phantom. The short-lived isotopes were used directly. For K-40, the isotope K-42 (half-life 12.5 hours – energy 1.52 MeV) was used.

The phantom in the picture consisted of containers that could be filled with liquids containing radioactive isotopes.

In the figure below, the activity of Cs-137 in reindeer meat was measured from 1965 to 1986. Furthermore, the activity in a group of people living in the area have been measured with the whole body counter. The results for these measurements are given in Bq per kilo.

As can be seen, the activity has decreased slowly since the tests in the atmosphere ceased until the end of the period shown. After the Chernobyl accident in 1986 the activity increased due to new fallout (Swedish results are given on the next page).

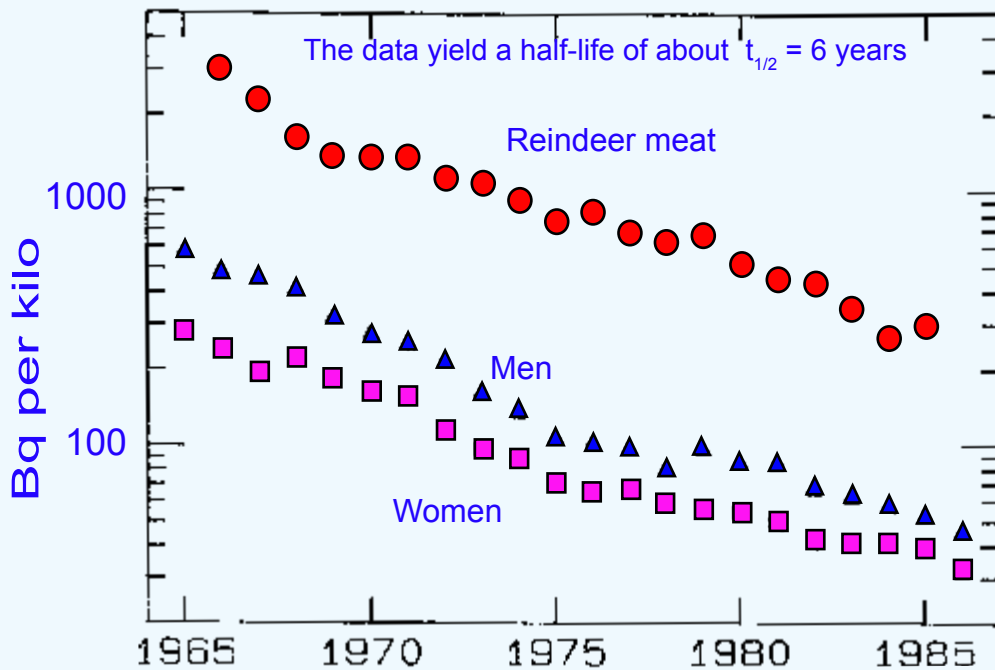

The content of Cs-137 in reindeer meat as well as in the people who own the animals. The example is taken from northern Norway. The activity is assumed to be evenly distributed in the body and is therefore given as Bq/kg. The reason for the difference between women and men is presumably the same as that for the content of K-40 (see the figure on page 102). Potassium and cesium are in the same column of the Periodic table and may be distributed in the body in the same way with a higher content when the muscle mass is large relative to the total mass. The ecological half-life calculated from these measurements is about 6 years.

(Data courtesy of A. Westerlund, Norwegian Radiation Protection Authority)

Based on the results in the figure above, it is possible to estimate doses to the people involved – and to calculate the ecological half-life. Nothing was done in order to reduce the fallout.

The data in the figure above can be fitted reasonably well to a straight line in the plot, implying that the activity decreases exponentially. The half-life is about 6 years for both the reindeer meat as well as for the people.

Half-life approximately 6 years

Swedish groups 1959 – 2000

Rolf Falk from SSI (Swedish Radiation Protection Institute) have carried out whole body measurements on groups in Sweden. In particular a group from Stockholm has been followed from 1959. The measurements, therefore, include the effect of both the bomb tests of the 1960s and the Chernobyl accident in 1986. The group has a different diet compared to the group of Lapps and the Cs-137 uptake was much smaller.

Furthermore, two groups (farmers and non-farmers respectively) from Gävle have been studied. Gävle is an area, north of Stockholm, which had the highest fallout (approximately 85 kBq/m²) in Sweden from the Chernobyl accident.

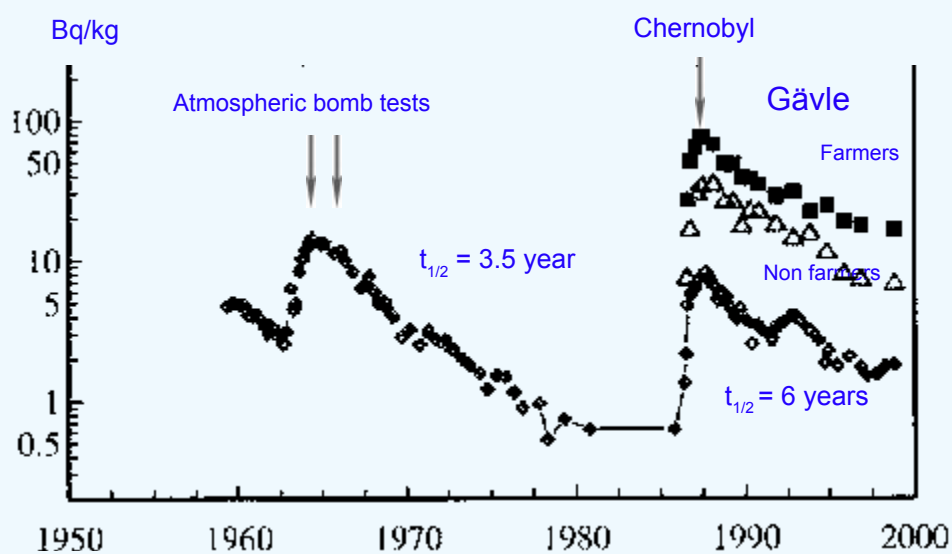

The figure shows the results of total body measurements on different groups of people in Sweden.

(Data courtesy of R. Falk, Swedish Radiation protection Institute, SSI).

As you can see, the total body activity for the Stockholm group reached a peak in 1965 (about 13 Bq/kg), which is a factor of 30 – 50 smaller than that of the Lapplanders (figure on the page above).

The data in the figure can almost be fitted by straight lines and consequently half-lives can be calculated. These half-lives may be considered as ecological half-lives and some values are given directly on the figures.

Doses involved

The data presented in the two figures also yield opportunities to make a rough calculation of the doses involved. Thus, we can estimate the dose obtained for the peak year (1965 for the bomb tests and 1986 for the Chernobyl accident), as well as the accumulated dose for the first 10 years (1965 - 1975 for the bomb tests and 1986 - 1996 for Chernobyl fallout).

These data are given in the table next page.

Cs-137 doses due to the atmospheric bomb tests and the Chernobyl accident

Groups	Bomb tests		Chernobyl	
	Dose peak year	Dose over 10 years	Dose peak year	Dose over 10 years
Lapps	1.5 mGy	8.8 mGy		
Gävle farmers			0.2 mGy	1.2 mGy
Stockholm group	0.03 mGy	0.14 mGy	0.03 mGy	0.18 mGy

The internal doses due to Cs-137 in the Lapps in northern Norway were among the highest to any group of people and very much higher than that to other members of the public. According to the figure on page 141 the Lapps had a whole-body activity in 1965 of approximately 600 Bq/kg for men and 300 for women corresponding to an equivalent dose of 1.5 mGy for men and 0.7 mGy for women that year.

The extra dose in the peak year was approximately half that obtained by commercial air crews every year. From the bomb tests over a 10 year period the dose to the Laplanders was approximately 8.8 mGy, whereas the dose to the Stockholm group was about 0.14 mGy.

For comparison; the dose from the natural background was about 30 mSv for the same period.

How to perform simple calculations of radiation doses ?



It is an important purpose of this project to give information about the nature of radiation and how it is possible to estimate – in fact calculate – doses involved. In the above table some values are given which seem to be interesting for most people. Therefore, we shall describe in more detail how it is possible to calculate radiation doses from radioactive isotopes in the body. The calculations are not exact but give a good overview of the doses and how you yourself can do estimations.

Radiation Doses from Cs-137 in the body

We shall give some details on how to estimate doses. We start with the data presented for the fallout after the bomb tests.

A radiation dose is, by definition, the energy deposited in the body. For radioactive isotopes we can estimate the energy deposited when we use the decay scheme. The decay scheme is a key in these calculations and the scheme for Cs-137 is given on page 23 in Chapter 2. For every disintegration both a β -particle and a γ -photon are emitted. The energy given off into the body consists of the following:

For the β -particle

The β -particles have a very short range in tissue and will consequently be absorbed completely in the body. The average β -energy (E_β) is approximately 1/3 of the maximum energy given in the decay scheme. The following calculation is used (see also the decay scheme):

$$E_\beta = 1/3 (94.6 \% \cdot 0.512 \text{ MeV} + 5.4\% \cdot 1.174 \text{ MeV}) = 0.183 \text{ MeV}$$

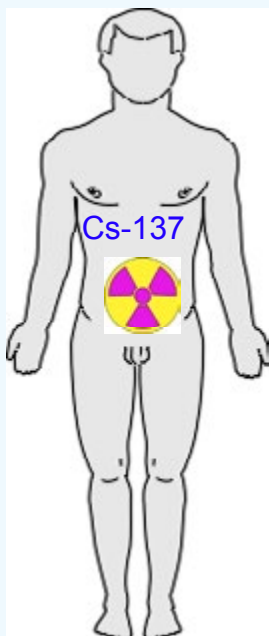

This means that the β -particles from Cs-137 deposit on average about 0.18 MeV per disintegration.

For the γ -radiation

The γ -radiation will be partly absorbed in the body and partly escape from the body. It is the part of the γ -radiation that escapes from the body that is used in the whole body measurements presented above.

The γ -radiation from Cs-137 has an energy of 0.662 MeV.

We know that x- and γ -rays are absorbed according to an exponential function. This implies that we can define the so-called "*a half-value layer*" – which is the amount of a material that is necessary to reduce the radiation to the half (50 %). With regard to protection it is usual to use concrete or lead. In this case we are interested in the half-value layer in tissue or water. In the present calculations we use a half value layer of 8 cm of soft tissue for the radiation from Cs-137.

Cs-137 is evenly distributed in the body. The γ -photons are emitted in all directions – and a rough estimate is, that approximately half of the γ -radiation is deposited in the body (i.e. E_γ is about 0.33 MeV per disintegration) – whereas half of the radiation escape and can be measured outside the body.

The total energy deposited in the body per disintegration is the sum of the energies from both the β -particle and the γ -radiation, i.e. 0.18 MeV plus 0.33 MeV, giving approximately 0.5 MeV per disintegration.

Cs -137

Energy deposited in the body per disintegration.

$$E = E_\beta + E_\gamma = 0.183 \text{ MeV} + 0.33 \text{ MeV} \approx 0.5 \text{ MeV}$$

Dose

The radiation dose is the energy deposited per unit mass, measured in J/kg. Cs-137 is evenly distributed in the body, and the energy deposited per kg would be the number of disintegrations multiplied by 0.5 MeV. In this calculation we assume that the body burden is n Bq/kg and constant throughout a full year (the requirements for this is that the intake of Cs-137 is equal to the excretion). With the above assumption the total number of disintegrations (N) would be n times the number of seconds in a year:

$$N = n \cdot 60 \cdot 60 \cdot 24 \cdot 365 \text{ Bq/kg} = 3.15 \cdot 10^7 \cdot n \text{ Bq/kg}$$

The radiation dose is the product of the number of disintegrations and energy deposited per disintegration (remember that $1 \text{ eV} = 1.6 \cdot 10^{-19} \text{ J}$):

$$D = 3.15 \cdot 10^7 \cdot n \cdot 0.5 \cdot 10^6 \cdot 1.6 \cdot 10^{-19} \text{ J/kg} = n \cdot 2.52 \cdot 10^{-6} \text{ Gy}$$

Since the radiation consists of γ -radiation and β -particles with a radiation weighting factor of 1, the dose would be the same in Sv.

Returning to the figures presented above, we see that the Lapplanders in 1965 had a body burden of 600 Bq/kg. The dose that year was, therefore, 1.5 mGy for men and about half that value for women. The peak year doses for the other groups are given in the table above (page 143).

Accumulated doses

As seen from the curves in the figures on page 141 and 142> the activities, and therefore the doses, decay exponentially. Since we roughly know the half-life, it is possible to estimate the total dose for 10 years. The accumulated dose for 10 years is found by the formula:

$$D_{\text{total}} = \int_0^{10} D_0 \cdot e^{-\lambda t} dt = (D_0 / \lambda)(1 - e^{-\lambda t})$$

Here D_0 is the first year dose, $\lambda = \ln 2/t$ where t is the half-life in years. Using this formula, the doses presented in the table above are obtained. These are doses in addition to the doses from natural sources.

The background radiation dose from the 4 natural radiation sources is about 3 mSv per year – constant. Thus for a 10 year period the accumulated dose is around 30 mSv. Here we use the unit Sv since we also include radon and α -particles. ICRP use a radiation weight factor 20 for α -particles.

Reactor accidents

During the years with nuclear reactors for making bombs and electricity we have had four major reactor accidents with release of radioactive isotopes. Furthermore, we have to mention the accidents in the Chelyabinsk Region with release of radioactivity. Unfortunately, it is almost impossible to attain knowledge of the amount of radioactive isotopes released – and even more difficult to arrive at extra radiation doses involved and their biological and health effects. However, these accidents have changed most peoples view on radioactivity and in particular nuclear power – which is disastrous in a time with global warming from burning of fossil fuels.

Let us however, briefly mention the following accidents in chronological order:

1. **Kyshtym** – September 29, 1957 (and in 1967).
2. **Windscale** – October 10, 1957.
3. **Three Mile Island** – March 28, 1979.
4. **Chernobyl** – April 26, 1986.
5. **Fukushima** – March 11, 2011

The Chernobyl accident is the most serious one. We shall in the following give some information about these accidents as known in 2011.

Kyshtym

It was in the Chelyabinsk province, about 15 kilometers east of the city of Kyshtym on the east side of the southern Urals that Igor Kurchatov built the first plutonium production reactor for the bomb program. The first reactor was built in 18 months and several more reactors were built – mainly for the production of plutonium. The area is now polluted by radioactivity, due to accidents and bad handling of radioactive waste.

In the first years they dumped radioactive waste in the Techa River. The amount and type of isotopes are uncertain (about 100 PBq is mentioned) mainly in the years 1950 and 1951.

In September 1957, the cooling system of a radioactive waste containment unit malfunctioned and exploded – and released a large amount of isotopes. The radioactive cloud moved towards the north-east, reaching 300–350 kilometers from the accident. The fallout of the cloud resulted in a long-term contamination of an area of more than 800 square kilometers with Cs-137, Sr-90 (a β -emitter with half-life 29.2 years), Zr-95 (65 days), Ce-144 (284 days) and others. Cs-137 and Sr-90 are of importance with regard to extra doses to the people in the region. A region of 23 000 km² was contaminated to a level of more than 1 Ci/km² (equal to 37 000 Bq/m²). In 1957 this region had 273 000 inhabitants. About 2000 lived in an area with 3700 kBq/m².

This area is usually referred to as the East-Ural Radioactive Trace (shown in the map next page).

The last event in this region happened in 1967. A small lake (Lake Karachy) that was used for waste disposals and during the long hot summer of 1967 the lake dried up and wind resuspended the sediments. About $22 \cdot 10^9$ Bq of Cs-137, Sr-90 and Ce-144 was released to the nearby region.

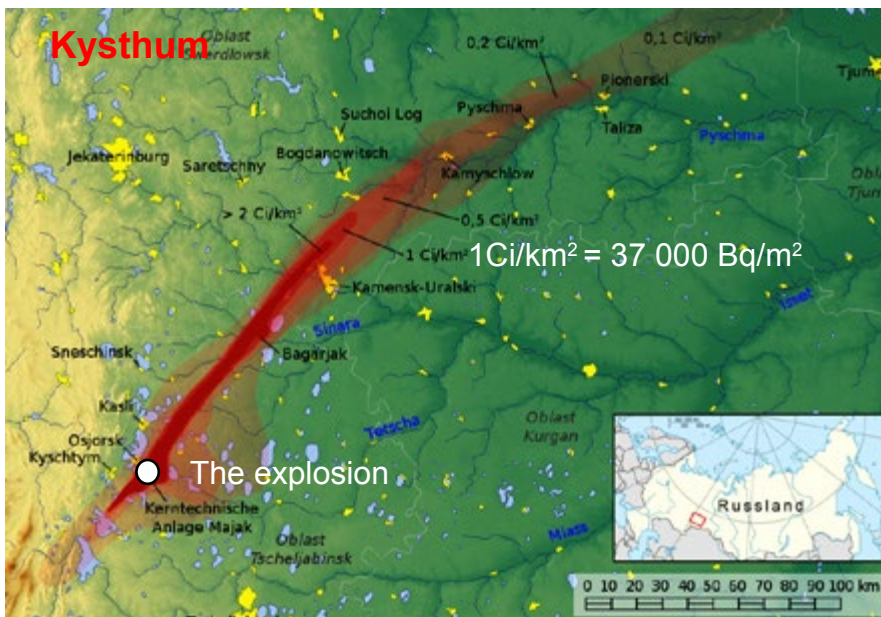

Here is a map of the area for the atomic accident in Kyshtym. The fallout area is shown and marked by red color. It is stretched out more than 100 km.

Some values for the total fallout is given on the map. All these values, as well as the doses to the people involved are mainly estimates. Extra annual doses via the food of 0.1 mGy have been mentioned.

Windscale

The Windscale reactors in Cumberland, England were built in order to produce plutonium for a fission bomb. The work started in 1947 and the first bomb was tested in Australia in October 1952. The two reactors in Windscale (today Sellafield) used graphite as moderator. It was known that when graphite was bombarded by neutrons, dislocations in the crystalline structure would cause a build up of potential energy (so-called "*Wigner energy*"). If this energy was allowed to accumulate, it could escape spontaneously in a powerful rush of heat. Therefore they used to release the energy by annealing – and it was during such an annealing process the fire started on October 10, 1957. It was just a fight in order to stop the fire. The core was burning for about one day and they managed to stop it by water.

The fire resulted in the release of radioactive isotopes such as I-131, Cs-137, Ru-106, Xe-133 and even Po-210. Altogether about 700 TBq was released. I-131 was considered to be the main problem – and it was found in the milk the day after. As a result the milk from a region of 500 km² was dumped into the Irish Sea for a month. The highest activity of 50,000 Bq/l was found in milk from a farm about 15 km from the reactor. Furthermore, as a result of this accident it was decided that milk with an activity of more than 0.1 μCi per liter (3700 Bq per liter) could not be sold. It was calculated that the thyroid dose to the people in the area was 5 – 20 mGy for adults and 10 – 60 mGy for children.



Estimation of thyroid doses

It would be of great value if we could calculate the dose to the thyroid after intake of I-131. With the knowledge we have it is possible to carry out rough estimates of the doses involved after intake of I-131 in milk and other food products.

Let us use the Windscale accident and the following scenario:

1. You drink 10 liter of milk containing 3700 Bq/l. This is an intake of 37 000 Bq.
2. All I-131 ends up in the thyroid gland – weighing 10 – 20 gram (lets use an average of 15 gram). For maximum dose we assume that all I-131 atoms disintegrate within the thyroid.
3. The half-life of I-131 is 8 days.
4. I-131 emits a β -particle with maximum energy 0.6 MeV and γ -radiation with an energy of 0.36 MeV.

All β -particles, with an average energy of 1/3 of the maximum energy, are absorbed in the thyroid. Only a small fraction of the γ -energy is deposited in the thyroid (lets assume 25 %), whereas a larger fraction escapes from the body (this is why this isotope can be used for diagnostic purposes). Consequently, a reasonable estimate is that each disintegration deposits approximately 0.3 MeV in the thyroid gland.

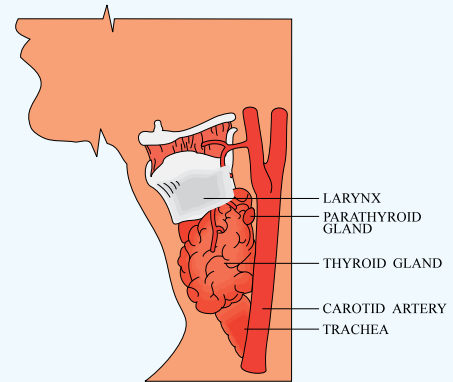

In the present scenario we assume a total intake of I-131 (A_0) to be 37 000 Bq. The total number of disintegrations (X) is found from the equation:

$$X = A_0/\lambda = 37,000/\lambda = 3.7 \cdot 10^{10}$$

In this calculation $\lambda = \ln 2/t$. For t we use the physical half-life of 8 days (the effective half-life is 7.6 days).

The energy deposition in the thyroid is then:

$$\text{Energy} = 0.3 \cdot 10^6 \text{ eV} \cdot 3.7 \cdot 10^{10} = 1.1 \cdot 10^{16} \text{ eV}$$

The energy deposited in the thyroid can be given in Gy if we assume that the weight of the thyroid is 15 gram

$$D = \frac{1.1 \cdot 10^{16} \cdot 1.6 \cdot 10^{-19}}{0.015} \approx 117 \cdot 10^{-3} \text{ J/kg} \approx 117 \text{ mGy}$$

The most sensitive parameter in this calculation is the weight of the thyroid. For children the weight is smaller and consequently the dose is larger using the same assumptions.

In this and other similar calculations we use the equations given in Chapter 3. The calculations give a reasonable idea of doses to the thyroid and can be used in scenarios in connections to accidents like Windscale and Chernobyl. The main pathway for I-131 to reach the thyroid is via milk.

Three Mile Island

A well-publicized accident happened on Three Mile Island near Harrisburg, Pennsylvania, March 28, 1979.

The cooling on a pressurized water reactor (PWR) was lost, and parts of the reactor core melted down in the course of 6 to 7 hours before the reactor was covered with water. The reactor had a safety container and only minor amounts of radioactivity were released. In fact, the activity released was smaller than that normally released every year from the natural radioactive sources in Badgastein, Austria, a source that some years ago was considered to be healthy (and may be it is).



Because of some misunderstanding between the Nuclear Regulatory Commission and the authorities, it was recommended that children and pregnant women, living within 8 km from the reactor be evacuated. This recommendation, which was quite unnecessary, had the unfortunate consequence of raising anxiety and fear among the public.

The Chernobyl accident – April 1986



Two pictures of the Chernobyl reactor

Left: A picture from 1986, just after the accident.

Above: A new picture which shows that the reactor is buried in its sarcophagus.

The Chernobyl accident was the most severe ever to have occurred in the nuclear industry. The accident occurred during a low-power engineering test of the Unit 4 reactor. The safety systems had been switched off, and improper, unstable operation of the reactor allowed an uncontrollable power surge to occur, resulting in successive steam explosions that severely damaged the reactor building and completely destroyed the reactor

The steam explosion, might have lifted the reactor core and all water left the reactor core. This resulted in an extremely rapid increase in reactivity, which led to vaporization of part of the fuel at the centre of some fuel assemblies and which was terminated by a large explosion attributable to rapid expansion of the fuel vapor disassembling the core. The explosion blew the core apart and destroyed most of the building. The dramatic accident which happened at 1.24 on April 26 was known to the world a couple of days later when the released radioactivity reached Poland and Sweden.

Today several detailed reports are available. We suggest the following web page with reports from UNSCEAR, WHO and IAEA up to 2008:

<http://www.unscear.org/unscear/en/chernobyl.html>

Let us start with the conclusion made by UNSCEAR based on the 2000 report of the Chernobyl forum.

The accident at the Chernobyl nuclear power plant in 1986 was a tragic event for its victims, and those most affected suffered major hardship. Some of the people who dealt with the emergency lost their lives. Although those exposed as children and the emergency and recovery workers are at increased risk of radiation-induced effects, the vast majority of the population need not live in fear of serious health consequences due to the radiation from the Chernobyl accident. For the most part, they were exposed to radiation levels comparable to or a few times higher than the natural background levels, and future exposures continue to slowly diminish as the radio-nuclides decay. Lives have been seriously disrupted by the Chernobyl accident, but from the radiological point of view, generally positive prospects for the future health of most individuals should prevail



Release of radioactivity

Several data exist with regard to the release of radioactivity from Chernobyl. Let us first conclude that the most important isotopes are I-131 (half-life 8 days) and Cs-137 (half-life 30 years). All effects from I-131 occurred during the first weeks after the accident. Thus, by the end of 1986 almost 40 half-lives had passed and the activity reduced by a factor 10^{12} .

Cs-137 on the other hand will reach 50 % of its start value in 2016.

Radioactivity was released for 10 days – it stopped rapidly on May 5. The amount released has been calculated – based on an estimation of the amount of radionuclides present in the core at the time of the accident. According to the last UNSCEAR report the release of Cs-137 is estimated to be 85 PBq, about 30% of the core inventory and that of I-131 is estimated to be 1,760 PBq, about 50% of the core inventory. If you use the equations in chapter 3 you can calculate the weight of the release. Thus, about 26.4 kg Cs-137 and about 382 gram of I-131 was released.

The released isotopes can be divided in classes according to the form and possibility to be transported over long distances. Thus UNSCEAR use the groups; noble gas, volatile, intermediate and refractory. It is the volatile elements such as I-131 and the Cs-isotopes that are of most concern to areas outside the vicinity of the reactor. As shown in the figure on page 68 the volatile isotopes reached Oslo and was measured on May 9, 1986.

In the table below we give some of the most important data for the release of isotopes. It is the UNSCEAR values from 1996.

Isotope	Half-life	Type	Amount (PBq)
Xe-133	5.3 days	Noble gas	6500
Cs-134	2.06 years	Volatile	~54
Cs-137	30.0 years	Volatile	~85
I-131	8.04 days	Volatile	~1760
Te-132	77 hours	Volatile	~1150
Sr-89	50.5 days	Intermediate	~115
Sr-90	29.2 years	Intermediate	~10
Ru-103	39 days	Intermediate	120
Ru-106	368 days	Intermediate	73
Ba-140	12.7 days	Intermediate	240
Zr-95	64 days	Refractory	196
Ce-141	32.5 days	Refractory	196
Ce-144	284 days	Refractory	~116
Pu-241	13 years	Refractory	~6

Fallout

Approximately half of the released activity fell out in the area around the reactor. All of the plutonium and most of the strontium (Sr-89 and Sr-90) fallout was restricted to a region within 30 km of the reactor. However, for the volatile isotopes (Cs-134, Cs-137 and I-131), the distribution was extensive. Belarus and the western parts of Russia received most of the cesium fallout, but considerable amounts were transported by the wind to western Europe.

During the first days after the accident, the wind direction was to the northwest (towards Scandinavia). Considerable amounts of fission products were transported to the middle regions of Sweden and Norway. Unfortunately, it was raining in some of these areas and the fallout was consequently large. Thus, in parts of Sweden (the area around Gävle, north of Stockholm) and in Norway the fallout of Cs-137 reached up to 100 kBq/m² (about 3 Ci/km²). The average value, however, was much smaller and on the order of 5 to 10 kBq/m².

The fallout is presented in the maps on the two next pages.

Cs-137 is given in the two maps on the next page. The amount is given by colors. Red yields the highest values. Regions with more than 37 kBq/m² are considered as polluted areas. This definition is rather low and implies that large areas in Scandinavia had a fallout above this limit. Furthermore, the maps indicate that the fallout in Scandinavia reached values like those quite near Chernobyl (compare the two maps).

No similar maps can be given for I-131 – due to the fact that the half-life is too short. However, it is reasonable to assume that the fallout of I-131 followed the same pattern as that for Cs-137. This may be of interest with regard to thyroid doses to people in western Europe.

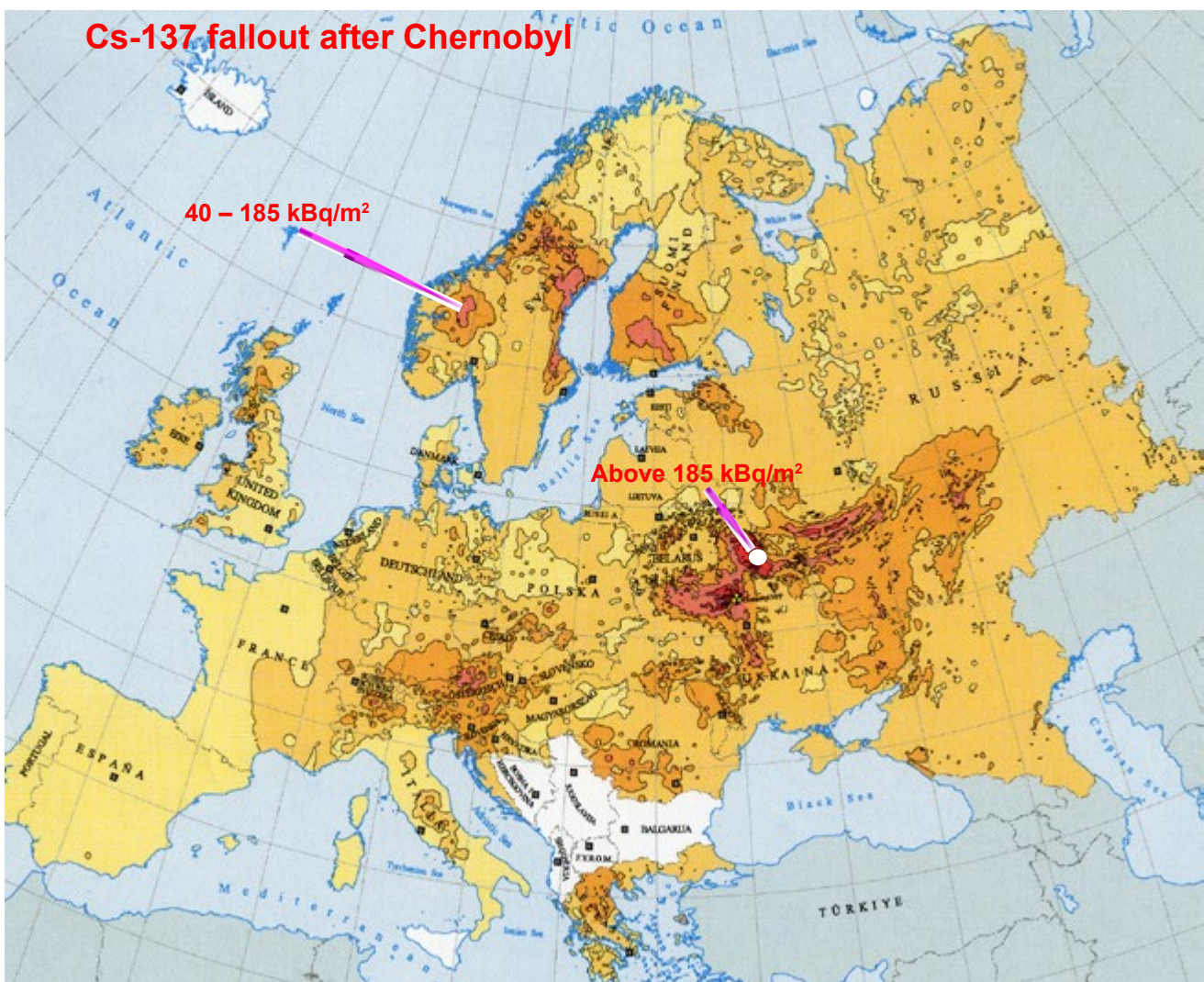

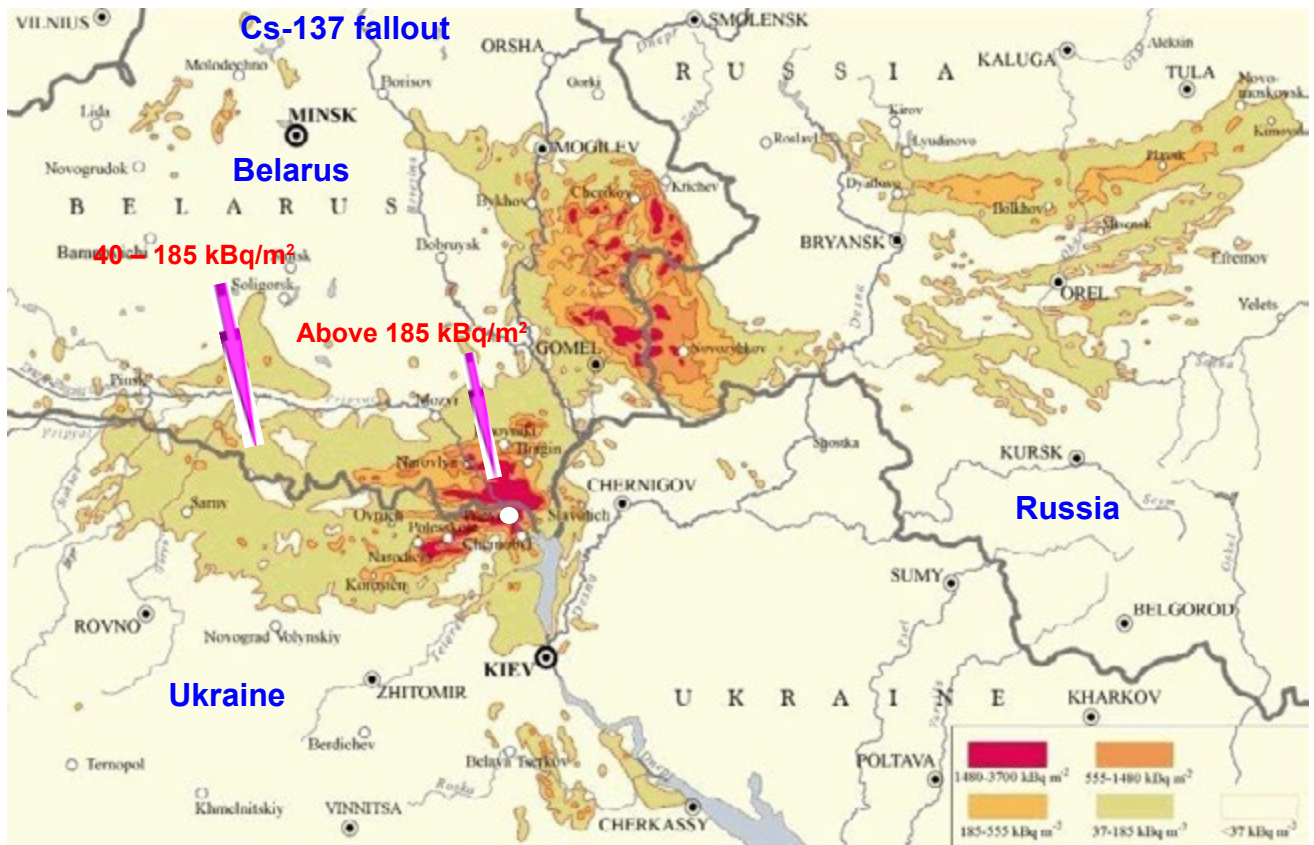

Here is given the fallout of Cs-137 (top), plutonium (Pu-239 and Pu-240) and Sr-90. The color indicate the total deposition. In the case of plutonium the colored area indicate levels above 3700 Bq/m². For Sr-90 the darkest colored area indicates a deposition above 111 kBq/m². The dashed circle indicate 30 km from the reactor.

The maps show that the fallout of strontium and plutonium is limited to the regions near the reactor. The reactor is in the middle of the circle, which marks the 30 km zone.

In the Nordic countries more than 20 laboratories become involved in measurements of the fallout from Chernobyl. During the first days Cs-137 and I-131 activity in the air was observed as well as the deposition on the ground. Later a large amount of measurements were carried out for different food products in an attempt to arrive at doses to the public.

On page 76 we have given an example how the different isotopes can be observed and measured for a sample with a mixture of different isotopes. The easiest way to identify the isotopes is by γ -spectroscopy.

The doses attained after accidents like Chernobyl can be estimated from the activity in the food products. We know quite a lot about the Cs-137 doses and almost nothing about the I-131 doses to the thyroid for young and old people outside the region around the reactor.

Cs-137 content in trout in a Norwegian lake

J. E. Brittain and coworkers have measured the content of Cs-137 in brown trout from Øvre Heimdalsvatn for a period of 22 years from 1986. The Cs-137 deposition in this area was the highest in Norway (on average 130 kBq m^{-2}). The activity in brown trout increased during the summer of 1986 and reached a maximum activity of 7200 Bq/kg in late August. The lake is ice covered from late October to the beginning of June. The Cs-137 concentration in trout (200 to 300 gram) has been measured all years after 1986. Today the activity is about 150 Bq/kg . The observed values are given in the figure below.

From this figure it can be found that the ecological half-life was 3.6 years for the first 6 years after Chernobyl. Then the value increased and approaches now the physical half-life for Cs-137 (30 years).

It would of course be of interest to obtain similar data for other areas and other ecosystems.

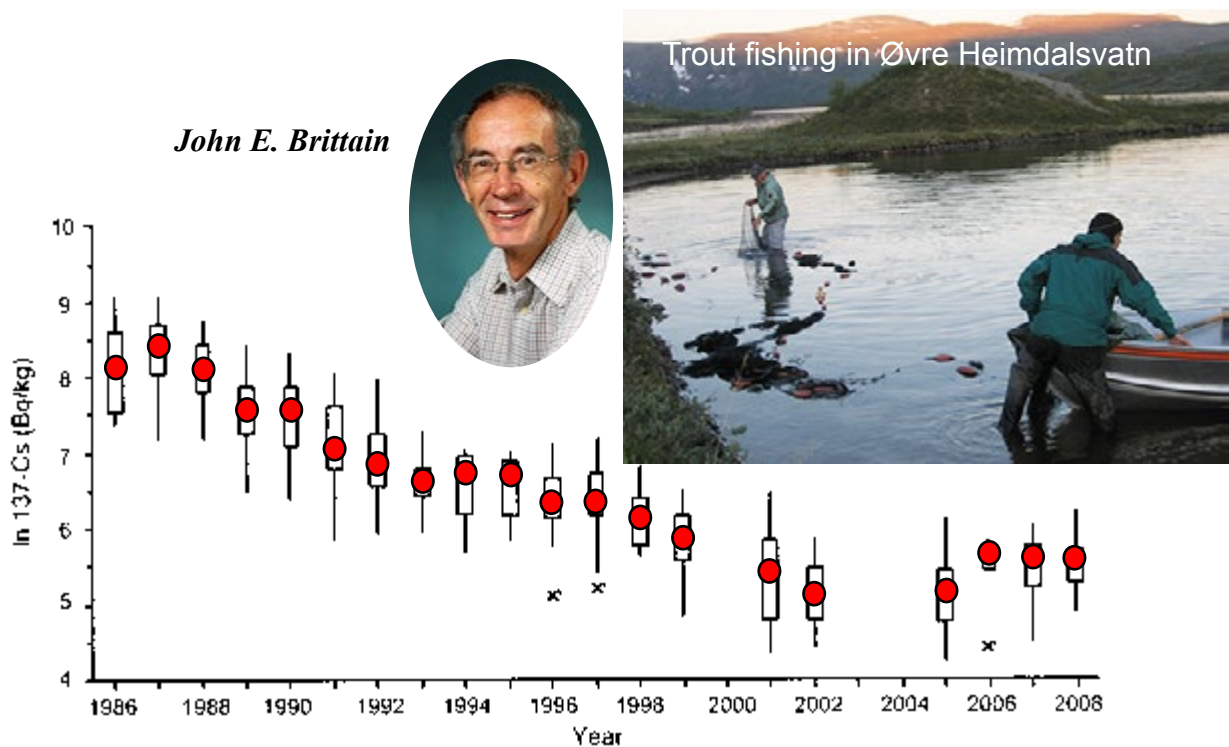

In this figure is shown the Cs-137 activity in brown trout from Øvre Heimdalsvatn for the period 1986 to 2008. The red dots show the average value. The activity is given in a logarithmic scale as $\ln(\text{Bq/kg})$.

Doses and health effects

It is evident that the doses to the general public in most areas are small. However, some brave workers made a heroic work with extinguishing the fire and covering the reactor. We shall give some details about those that received the largest doses and carried the burden of the Chernobyl disaster. The section is divided into:

1. Emergency workers involved in the accident the first days.
2. Decontamination workers in the period 1986 – 1990.
3. The groups evacuated.
4. Public in general.

1. Emergency workers

About 600 workers were on the site on the morning of 26 April. The workers were faced with a situation with several fires in an open very strong γ -source. It was the γ -radiation that was the real treat. Furthermore, the released radionuclides in the air could be inhaled and dust particles could be deposited on the skin and in the cloths. The power plant workers carried film badges that could register doses up to about 20 mGy – the firemen carried no dosimeters. The situation can best be explained by the two figures below.

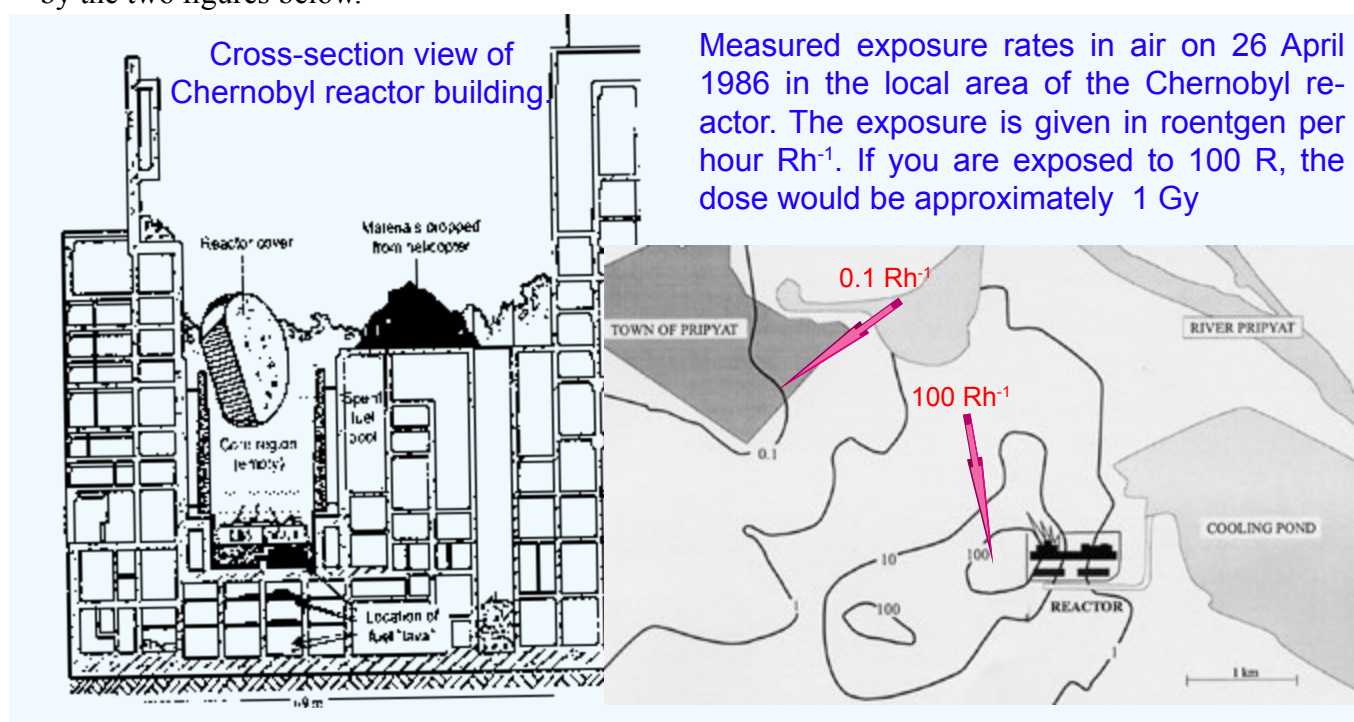

The dose rates on the roof and in the rooms of the reactor block reached hundreds of gray per hour. It is reasonable to assume that most of the workers were well aware of the radiation. These people – firemen and others, helicopter pilots – those working with extinguishing the fire and covering the damaged reactor are the real heroes of this accident.

The number of heavily exposed workers present at the reactor site in the early hours of 26 April 1986 was 203. Of these, 115 were treated for acute radiation syndrome, beginning on day 2, at the specialized treatment centre in Moscow (the leader of the department was A.K. Guskova). In Kiev 12 more patients with acute radiation sickness were hospitalized.

More than 140 workers got whole body γ -radiation doses of about 2 Gy – and more. The doses were not measured directly – but have been assumed based on ESR-measurements on dental enamel. These measurements agreed within $\pm 20\%$ with the dose estimates based on clinical and biological criteria i.e. the number of chromosome aberrations (dicentric) in a blood-lymphocyte culture. The doses calculated to those treated in Moscow is given in the following table.

Number	Dose range (Gy)	Number of deaths	Days to death
31	0.8 – 2.1	0	
43	2.2 – 4.1	1	96
21	4.2 – 6.4	7	16 – 48
20	6.1 – 16	20	10 – 91
115		28	

The internal radioactivity was measured – even whole body counting was performed. The thyroid doses were rather low, mainly below 1.2 Gy. The internal Cs-doses were much smaller than the external doses (mainly 1 – 3 %).

The medical unit evacuated people from the reactor vicinity – starting only 30 minutes after the accident. They also distributed potassium iodide in order to minimize the thyroid dose. A large number of people were examined and the diagnosis of "*acute radiation sickness*" was given to 106 workers. Let us briefly mention the bone marrow syndrome and the observations that are involved.

Bone marrow syndrome

Failure of the bone marrow is the cause of death for whole-body doses in the range of 3 to 10 Gy. Experiments with whole body irradiation of mice (see figure below) show a significant decrease in white and red blood-cells. This situation was also observed for the accident in Norway (see the figure on page 80). A dose of 5 Gy will kill about 99% of the hematopoietic stem cells in mice. The stem cells are necessary for the production of circulating blood cells (erythrocytes, granulocytes and platelets). A reduction of these cells will result in anemia, bleeding and infections.

The first sign of such radiation sickness is nausea, vomiting and diarrhea. This situation may disappear after a couple of days. Then, the consequences of lost blood cells become evident. Again, significant diarrhea may take place, often bloody, and a fluid imbalance may occur. This, together with bleeding, occurs in all organs. In addition, if infections occur, death may take place in the course of a few weeks.

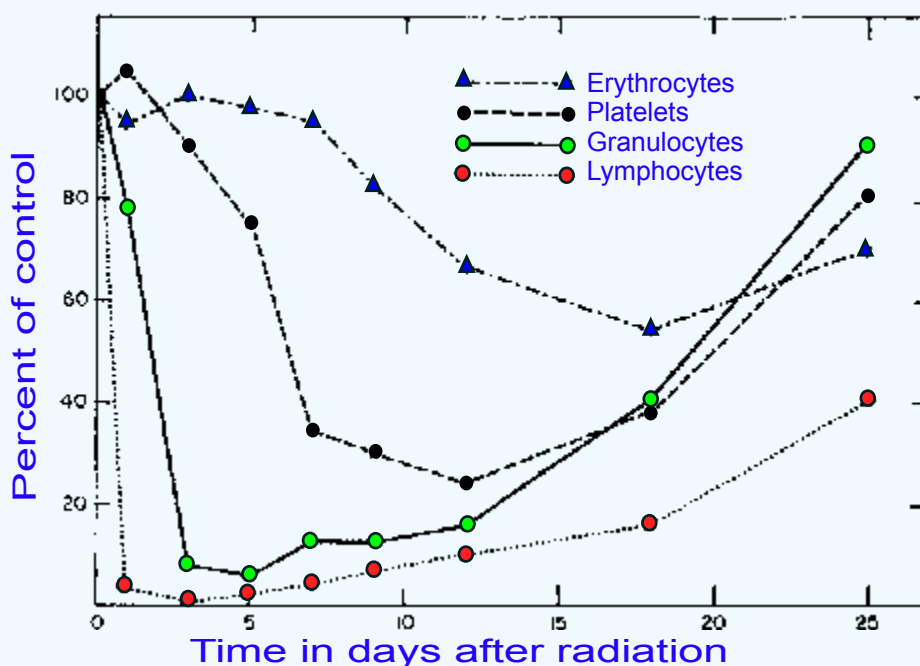

All patients with bone marrow syndrome were treated separately. With the onset of fever, intravenous administration of two or three broad-spectrum antibiotics was prescribed.

A total of 13 allogeneic bone marrow transplantations and six embryonic liver cell transplantations were performed.

Seven of 13 patients died as a result of skin and intestinal injuries before bone marrow engraftment could be expected.

Three patients died of "graft-versus-host disease" and two survived.

It must be concluded that we in 1986 did not have enough knowledge to perform bone marrow transplants with success.

The average dose to those 28 that died in Chernobyl was 8.5 Gy. The first one died after 10 days and the last one lived for 96 days. The Norwegian worker with a whole body dose of 22.5 Gy lived for 13 days (see page 79).

Altogether 820 persons were so-called "emergency workers" and witnesses to the accident. 87 percent of them got a whole body dose of more than 0.5 Gy.

2. Recovery operation workers

About 600,000 persons (civilian and military) have received special certificates confirming their status as liquidators. Of those, about 240,000 were military servicemen. The principal tasks carried out by the recovery operation workers (liquidators) included decontamination of the reactor block, reactor site, and roads (1986 – 1990) and construction of the sarcophagus. With regard to dosimetry, several groups have been considered separately – sometimes with physical dosimeters and sometimes without. After the first days, the workers carried dosimeters. No one was treated for acute radiation syndrome.

Of particular interest are the 226,000 recovery operation workers who were employed in the 30-km zone in 1986 – 1987, as it is in this period that the highest doses were received. The external radiation doses have been estimated in one of three ways: (a) individual dosimetry, (b) group dosimetry (an individual dosimeter was assigned to one member of a group that should perform a particular task) or (c) time-and-motion studies (measurements of gamma-radiation levels were made at various points of the reactor site, and an individual's dose was estimated as a function of the points where he or she worked and the time spent in these places).

Let us mention some groups.

Helicopter pilots

A number of helicopter pilots (1125) worked the first days with covering the damaged reactor. They were exposed to γ -radiation during this work. The doses to pilots were estimated using either personal dosimeters or, less reliably, calculations in which the damaged reactor was treated as a collimated point source of radiation. The doses obtained by calculation were checked against the results derived from the personal dosimeters for about 200 pilots.

The average dose estimates are 260 mGy for the pilots who took part in the mitigation activities from the end of April to the beginning of May, and 140 mGy for the pilots who were exposed after the beginning of May.

Workers making the sarcophagus

In order to build the sarcophagus a group of 626 workers from the Kurchatov Institute was used. They worked both outside and inside the damaged reactor. The doses involved have been estimated on both ESR and by biological dosimetry (see inset next page). The recorded and calculated doses show that more than 20% received doses between 50 and 250 mGy, and that about 5% of them received doses between 250 mGy and 1.5 Gy. Using the FISH technique for three nuclear research specialists resulted in doses of 0.9, 2.0 and 2.7 Gy.

Average doses to recovery workers

The doses to the recovery workers during the first two months are not known with much certainty since the dosimetry was inadequate until the middle of June. From July 1986 onwards, individual dose monitoring was performed for all non-military workers, using either TLDs or film dosimeters.

The maximum dose allowed during the year 1986 was 250 mGy. The average effective dose from external gamma irradiation to recovery operation workers (approximately 200 000) in the years 1986 – 1987 was about 100 mGy, with individual effective doses ranging from less than 10 mGy to more than 500 mGy.

The remainder of the recovery operation workers (about 400,000), received lower doses. This group includes those who worked inside the 30-km zone in 1988 – 1990, and those who decontaminated areas outside the 30-km zone.

Internal doses – thyroid doses

"*In vivo*" thyroid measurements were carried out on more than 600 recovery operation workers. The thyroid doses were estimated based on these measurements. The average value was 210 mGy – individual doses up to 3 Gy. The main entrance of I-131 to the body was via food in particular milk. Both the measurements and the estimations of thyroid doses are very rough and uncertain.

Stable iodine prophylaxis was used by some of the recovery operation workers, but it was not mandatory nor was it proposed to everybody.

The internal doses resulting from intakes of radionuclides such as Sr-90, Cs-134, Cs-137, Pu 239 and 240 have been assessed for about 300 recovery operation workers who were monitored by whole body measurements from April 1986 to April 1987. The average value of the effective dose committed was estimated to be 85 mSv.

Biological dosimetry

The γ -doses to several groups of workers involved in the Chernobyl accident, have been estimated by two types of dosimeters. 1) ESR measurements on induced stable radicals and 2) chromosome aberrations.

In chapter 6 (pages 82 – 83) we described the ESR-dosimetry which was used for the first time in an accident at Kjeller, Norway in 1982. Furthermore, the recent development have made this technique useful for doses in the mGy-region. However, it must be concluded that the doses determined in the Chernobyl accident are very uncertain.

Biological dosimetry, i.e. observations of chromosome aberrations is based on changes induced in the chromosomes – such as *dicentric*s and *translocations*.

The frequency of aberrations (such as dicentric, rings and fragments) as measured in peripheral lymphocytes has been used for dosimetry since the 1960s. In this method lymphocytes, which mainly are in the G_0 phase of the cell cycle, have been stimulated to go into the cell cycle – they are cultivated for 48 hours at 37 C° and harvested when they are in metaphase. The chromosomes are stained and one can search for aberrations. It is quite easy to observe dicentric and the frequency is related to the dose – an example is given in the figure below. The dose-effect curve is found to be linear-quadratic. The method was used in Chernobyl and the doses correlated with those from ESR.

The chromosome aberrations like dicentric are unstable with time after exposure which make the dose reconstruction uncertain. Other more stable chromosome aberrations are "translocations". A fraction or part of one chromosome become attached to another. An "inversion" is a chromosome rearrangement in which a segment of a chromosome is reversed end to end.

The translocations can be observed by the so called "chromosome painting", a method based on the FISH technique (Fluorescence in situ Hybridization). The technique is useful to estimate cumulative radiation exposure and have been used since the mid 1990-ties.

The FISH-technique has been used in some retrospective studies on some Chernobyl workers. However, the technique is not sufficiently sensitive to allow estimation of individual doses in the low dose range received by the majority of recovery operation workers.

A drawing of a normal chromosome with one centromere.

Dicentric is when two centromeres are observed.

Below is a translocation.

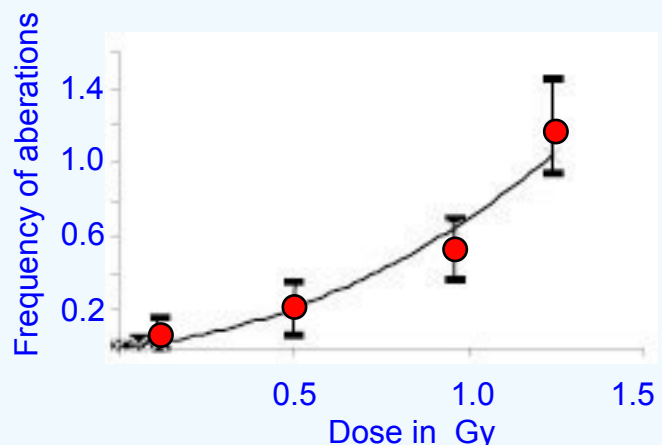
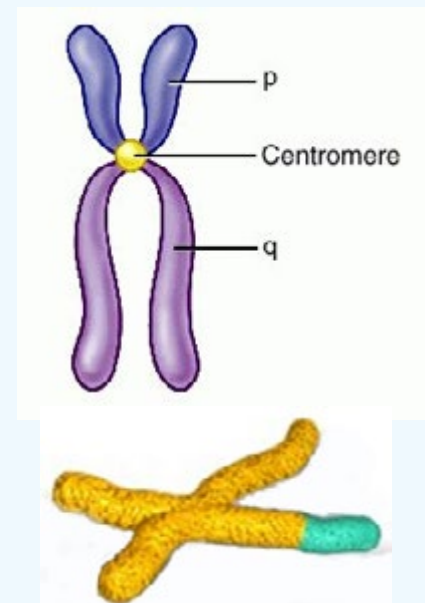

3. Evacuated groups

In the evening of April 26 the exposure rate in Pripjat, about 3 km from the damaged reactor, reached 1 – 10 mR (roentgenunit) per hour (approximately 0.01 – 0.1 mGy). This level was not too alarming, but they considered the situation to be serious. They considered the possibility that the burning reactor core might melt the concrete floor and fall into cellars below which may be filled with water. This could have given a vapor explosion with more release of radioactivity (later it became known that there was no water in the cellars). Late evening it was decided to evacuate the people (about 50 000) the next day. The first evacuation of more than 40 000 took place on April 27 by 1200 buses and was done in 3 hours.

More people were evacuated during the first days up to May 7. Later more people were evacuated – and altogether 116 000 people was evacuated the first year.



Dose level and evacuation

You can probably evaluate the dose level measured in Pripjat. Assuming an exposure rate of 1 mRh⁻¹ constant throughout a full year would give you a dose of about 8 mGy per year.

For the people living around the reactor, an exposure level of 5 – 20 mRh⁻¹ was used as a criterion for evacuation. If such an exposure level is kept constant for a full year the effective dose would be from 40 – 160 mGy.

The exposure rate after this accident would certainly not be constant. The short-lived isotopes – which are the most important during the first weeks, would disappear and only the Cs-isotopes would be back. Consequently, one would assume that the evacuated groups would return to their homes when the exposure rate went down.

As we know today this evacuation caused a lot of psychological and social problems. Consequently, it can be concluded that the evacuation of most of the people created more serious health problems than the extra radiation (which they tried to avoid) could ever do.

It is an extremely difficult task to evaluate the doses to the groups living in the neighborhood of the reactor and elsewhere with fallout from the accident. A large number of measurements have been carried out – and even more estimations have been done. For those interested, it is worthwhile to go to the UNSCEAR report from 2000 which can be found on internet with the address:

<http://www.unscear.org/docs/reports/annexj.pdf>

Let us give a short summary and some comments based on the UNSCEAR report.

Efforts have been made to estimate the doses during and through the first weeks after the accident. Furthermore, external doses due to the fallout during the first year have been calculated for groups in Belarus, Russia and Ukraine.

The conclusion is that the doses to the evacuees from external irradiation were mainly due to the isotopes deposited on the ground – and that the irradiation during the passage of the radioactive cloud played a minor role.

External doses

The external γ -dose is mainly due to the volatile isotopes Te-132, I-131 and the Cs-isotopes. Measurements like that given on page 68 for Oslo was carried out in May and June. Based on the measurements it is possible to reconstruct the situation immediately after the accident. The largest contribution to the external dose is from the short lived isotopes. However, after a couple of months, i.e. in July 1986 these isotopes had already been reduced by a factor more than 10^3 – and by the end of the year by a factor more than 10^6 .

The estimation showed that the effective dose to about 30,000 evacuees from the city of Pripjat and other settlements in the 30-km zone was about 17 mGy on average. Overall, it is estimated that about 86% were exposed to doses lower than 50 mGy, and only about 4% were exposed to doses greater than 100 mGy.

In the case of the evacuees from the Belorussian territory the estimated average dose was 31 mGy.

It can be noted that estimations indicate that the doses to those evacuated from Pripjat (27 April) were lower than would have been experienced if there had been no evacuation. For examples, the evacuation reduced the number of people from about 1,200 to 28 persons for those who obtained doses above 400 mGy. The health gain (if any) must be valuated against all the health problems the evacuation created.

External doses during the first years

Since 1991, methods for average dose estimation have been introduced based on TLD measurements and Cs-137 whole-body counting. Average effective doses from external irradiation received during the first 10 years after the accident are estimated to range from 5 mGy in the urban areas of the Russian Federation to 11 mGy in the rural areas of Ukraine.

Internal doses

The doses from internal exposure came essentially from the intake of I-131 and other short-lived isotopes during the first days or weeks following the accident, and subsequently, from the intake of Cs-134 and Cs-137.

The doses from the Cs-isotopes have been estimated based on the dietary intake from measured concentrations in foods. In addition whole-body counting have given some data. On pages 123 – 124 you can see how doses from Cs-137 can be calculated.

The calculations resulted in an average internal effective dose during the first 10 years after the accident to range from 4 – 13 mGy. This is much lower than the dose received from natural radiation.

It can be of interest to mention the results from a large number of whole-body measurements on Cs-137 for those living in the polluted areas of Belarus, Ukraine and Russia. The overall concentration is given as 50 Bq per kg body weight. However, no information is given about the time for the observations. In order to judge the value given (50 Bq/kg), you can go to the figures on page 141 and 142. You see that the Lapps living to a large extent on reindeer meat, in 1965 had a body burden of 600 Bq/kg (men) and 300 Bq/kg (women). The Gävle farmers after Chernobyl (about 70 Bq/kg). It must be remembered that for all areas we must take into account an ecological half-life – which according to previous experience probably is in the range 3 – 6 years in the first years afterwards. According to J. Brittain's observations for trouts in Øvre Heimdalsvatn (page 154) the ecological half-life increases and may probably be more equal to the physical half-life.

Summing up

As a rule of thumb for estimating accumulated doses to people living in areas with Cs-137 pollution UNSCEAR indicate that a pollution of 1 kBq/m² will give an accumulated extra lifetime dose of 0.16 mSv. However, we know that all fallout products slowly will both die out and more important be buried into the ground.

If we use the above value for the people living in the most polluted areas (above 185 kBq/m²) they may expect an extra lifetime dose of about 30 mSv. It is necessary to mention that the accumulated dose from the natural radiation yield a dose of more than 5 times this value.

Thyroid doses

Because of the thyroid cancers observed for children exposed by the Chernobyl accident, it has been considerable interest to arrive at estimate for the thyroid doses. The main route of exposure for the thyroid dose was the pasture-cow-milk pathway, with a secondary component from inhalation. A large number of measurements of radio iodine contents in the thyroids of people were conducted in Belarus, the Russian Federation and Ukraine to assess the importance of the thyroid doses.

The average thyroid dose to those evacuated (116 000) has been estimated to 0.47 Gy. Doses to the children was in general found to be larger. Thus, the doses to children (up to 15 years) in Ukraine (Pripyat and others in the 30 km zone) were in the range 0.1 – 2.1 Gy. For Belarus the doses were in the range 1.0 – 4.3 Gy.



Another scenario with I-131 and thyroid dose

On page 148 we have presented a scenario in connection to the Windscale accident. We can make another scenario based on Chernobyl.

1. You drink 1/2 liter of milk every day for 160 days – or 20 half-lives for I-131.
2. The start value for I-131 can be set to 100 000 Bq per liter.

As given in the scenario on page 148 each disintegration deposit 0.3 MeV in the thyroid gland. We assume natural decay of I-131 with half-life of 8 days.

During the 160 days after the accident you drink 80 liter of milk – containing 50 000 Bq the first day – and then successively smaller and smaller amount. The total amount of I-131 (N) can be found as follows;

$$N = \int_0^{160} N_0 \cdot e^{-\lambda t} dt = \frac{N_0}{\lambda} (1 - e^{-\lambda \cdot 160}) = \frac{N_0 \cdot 8}{\ln 2} (1 - e^{-160}) \approx 577 \text{ kBq}$$

The rest of the calculation would be equal to that on page 148. The dose to the thyroid gland (15 gram) would be 1.82 Gy.

Doses to people in Scandinavia

It is evident from the maps on page 152 that the fallout was rather large in Scandinavia. In the most polluted areas more than 100 kBq/m² Cs-137 was measured. Consequently, food products (mainly meat from sheep and reindeer) contained Cs-isotopes to a level of more than 100 000 Bq/kg. Due to the short half-life of Cs-134 of 2 years, the activity decreased rapidly during the first years. Shortly after the accident, the activity ratio between Cs-134 and Cs-137 was approximately 1 : 2.

Calculations indicated that the average equivalent dose to people in Scandinavia was approximately 0.2 mGy the first year after the accident. About 2/3 of the dose was due to food products, and about 1/3 was due to external γ -radiation.

The authorities in Norway and other countries introduced maximum values for Cs-137 in food products. However, no guidelines had been worked out and consequently the maximum level changed from one country to another. In Norway the maximum level for Cs in food products was set at 600 Bq/kg – a value that probably would have ruined the reindeer business. This conclusion is based on the experience from the fallout after the bomb tests on Novaja Zemlja (see the results on page 141), which indicated a half-life of about 6 years for reindeer meat. Consequently, the maximum level was increased for reindeer meat to 5000 Bq/kg. The official argument for this was that we eat very little reindeer meat.

Comment on Cs-137 doses

With the knowledge we have it would be of interest to give a rough estimation of the doses in combination with Cs-137 content in food products.

Let us assume a dinner with reindeer meat containing 100 000 Bq/kg (about the maximum ever measured). We assume that you eat 200 gram and your weight is 70 kg.

Cs-137 has a physical half life of 30 years, but is rapidly excreted from the body. The biological half-life is approximately 3 months – which gives an effective half-life of about 90 days.

The total number of disintegrations (x) in your body by eating 20 000 Bq of Cs-137 is given by:

$$x = \int_0^{\infty} A_0 \cdot e^{-\lambda t} dt = \frac{A_0}{\lambda} = 2.24 \cdot 10^{11}$$

Here $A_0 = 20\,000$ Bq.

$\lambda = \ln 2 / t_{1/2}$ and the effective half-life of 90 days is used.

The integration time goes to infinity, but during the first year more than 93% of the dose is given.

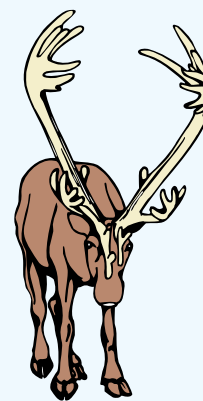

On page 144 we see that each disintegration yields an energy absorption of about 0.5 MeV. Furthermore, cesium is distributed evenly throughout the body. The total energy deposition in the body (weighing 70 kg) is therefore $1.12 \cdot 10^{17}$ eV. Since $1 \text{ eV} = 1.6 \cdot 10^{-19}$ joule the following dose is obtained:

$$D = \frac{1.12 \cdot 10^{17} \cdot 1.6 \cdot 10^{-19}}{70} = 2.56 \cdot 10^{-4} \text{ J/kg}$$

This calculation shows that the total dose after intake of food with 20 000 Bq of Cs-137 is:

$$D = 0.256 \text{ mGy} = 0.256 \text{ mSv}$$

Radiation weight factor is 1

If you have such a meal every month through a year the dose would be 3 mSv – or approximately equal to that from the natural radiation (see chapter 7).

Considerations with regard to max-values in food products

With background in the above considerations it can safely be concluded that the dose to the general public in combination with the Chernobyl accident would have been lower than the dose from natural radiation whether food restrictions had been introduced or not the first year after the accident. In the following years the dose would have been smaller and smaller.

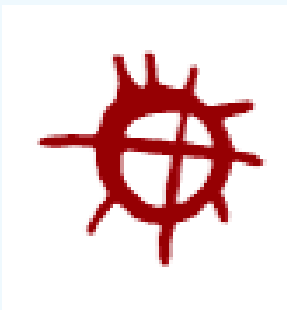

With basis in radiobiology we can conclude that introduction of maximum values was unnecessary and that we paid a heavy load in the efforts to reduce the radiation dose.

(However, if we assume that the LNT-hypothesis is valid, it is possible to calculate the collective dose which was saved – and from this dose the number of fatal cancers avoided. According to the LNT-hypothesis all radiation – also the natural radiation is deleterious and should be avoided if possible.)

The radiation authorities use the LNT-hypothesis in their work and was forced to implement maximum values in connection with the Chernobyl disaster. Since the zero-level was not attainable, the value was set as low as possible within reasonable limits.

An important effect, so far not mentioned, is that these maximum values resulted in an irrational fear for radiation which have had large psychological effects. It would have been nice if the radiation authorities could work out examples like that above – rather than using the LNT-hypothesis.

If maximum levels should be introduced, a rule of thumb would be that the extra dose from a pollution should not exceed the dose from natural radiation. In connection to the Chernobyl accident the limit could have been set at for example 0.01 mCi in a year. The curie unit would not scare people whereas 370 000 Bq is a very large number.

Thyroid and other cancers after Chernobyl

Cancer is the only late effect after radiation that has been observed and where we know parts of the mechanism. It starts with a DNA-damage to a cell that is not repaired (or misrepaired). The damaged cell must be triggered to go into the cell cycle and is not stopped on the way. This results in two damaged cells.

Previously, we have discussed lung cancer for underground miners due to radon doses (page 110). Cancers have also been observed for the survivors of the bombs in Japan in 1945. The radiation dose in Japan was due to a burst of γ -rays and neutrons, whereas the dose from radon is due to α -particles from the radon daughters and given in the course of several years. The lung doses that may give lung cancer seems to be above 1 Gy (page 110).

In combination with the Chernobyl accident a number of rescue workers received extra doses of 100 mGy and more. Another group is all the children exposed to I-131 during the first days after the accident. For both rescue workers and the children exposed to I-131 the dose represents a problem. Let us look into the two groups and see what we know today.

Thyroid cancers

About 4000 thyroid cancer cases have been diagnosed in the period 1992–2002 in persons who were children at the time of the Chernobyl accident and lived in the polluted areas. Only a few cases (15) have resulted in death. Furthermore, it is reasonable to assume that a large fraction of the cases would have been unobserved since thyroid cancer is in general quite benign. However, a large screening project has been performed in the polluted regions.

The main pathway of the thyroid doses in Chernobyl was through ingestion of foodstuffs, especially milk, containing high levels of radio iodine. We have previously (see page 148 and 162) made scenarios with I-131 and thyroid doses. In the Chernobyl scenario we used a start value of 100 000 Bq per liter. The child should drink 1/2 liter every day for 160 days. The resulting dose was 1.82 Gy. Larger values would be obtained assuming a smaller thyroid gland and otherwise similar conditions. The uncertainties in the dose determinations after Chernobyl is the following:

- 1.** The determination of I-131 to milk was based on measurements of all the activity in milk. No good γ -spectroscopy with germanium detectors was carried out. See the Oslo-measurements on page 76.
- 2.** The measurements of the I-131 concentrations in the thyroid was based on measurements to the neck of a number of people. Again no γ -spectroscopy was performed.
- 3.** The size of the thyroid gland for these children is not known. This parameter is very important in the estimations of the dose.

A lot of research have been carried out in recent years to attain more information on thyroid cancer. This research include the following groups: 1) The survivors of atomic bombing in Japan, 2) Marshall Islanders exposed to nuclear test fall-out, 3) Children exposed during therapeutic external radiation therapy.

The conclusions are as follows: Thyroid nodules of all types and sizes, including small ones detected by screening methods, are increased by radiation exposure. Furthermore, the thyroid is among the most radiation-sensitive tissues in the body, with excess cancers occurring at doses as low as 100 mGy. It was found that both iodine deficiency and iodine supplementation seems to modify the risk. The appearance of childhood thyroid cancer was larger in iodine-deficient populations, and it can be noted that all the areas involved in the Chernobyl accident had some level of iodine insufficiency in 1986.

Russian emergency workers

V.K. Ivanov and coworkers have studied the health effects on 65 905 Russian emergency workers. They got an extra dose of from 5 mGy to 300 mGy (average 100 mGy). The number of deaths in this group, up to 1998 was 4995. Four different classes of death are considered. They are based on WHO and are; 1. Malignant neoplasms. 2. Cardiovascular diseases. 3. Injuries and poisoning. 4. Causes from diseases other than those above.

The control was the mortality rate for the corresponding ages (males) in Russia. The results show that the mortality for the emergency workers is **lower** (only 82 %) than the general Russian rate. Also the incidence of cancer was lower for the emergency workers.

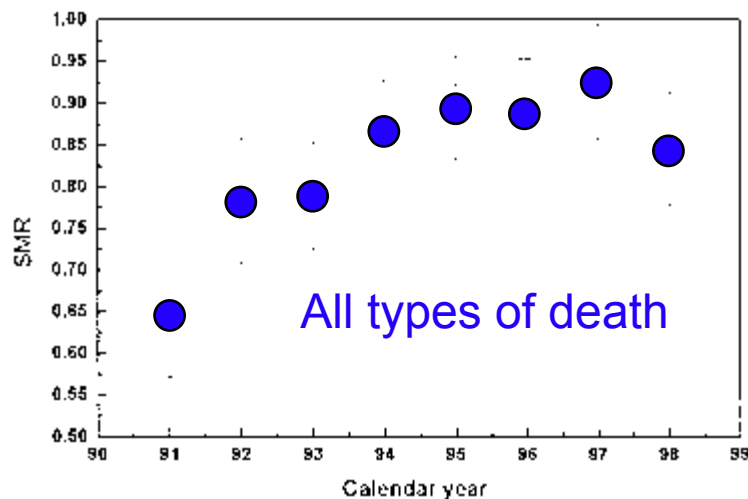

In the figure above is given the deaths of Russian emergency workers in the period 1991 to 1998. The death rate is compared to the general Russian rate with SMR = 1.0 "Standard Mortality Ratio". Below is given the data for cancer.

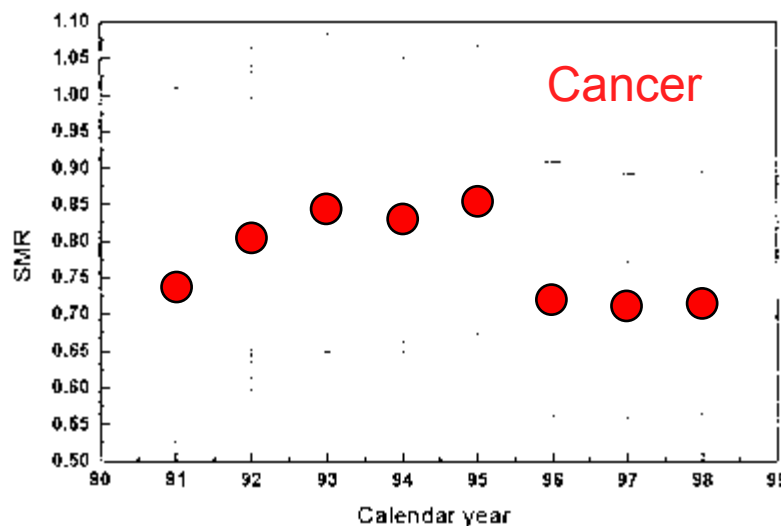

Chernobyl – Summary

Approximately 25 years after the accident we can sum up as follows.

1. The Chernobyl accident was the largest and most severe reactor accident ever. The accident itself resulted in 31 acute casualties – 28 due to the acute radiation syndrome.

2. Large areas were contaminated. People in the regions must live with Cs-137 and Sr-90 contamination for hundreds of years to come.

3. An increase of childhood thyroid cancer has been observed in the most contaminated areas in Belarus, Ukraine and Russia.

4. There is no evidence of other radiation-induced cancers in the three most contaminated countries at this time. Interesting data for Russian emergency workers indicate a positive effect of radiation. The reports and statements up to now are based on the LNT-hypothesis.

5. The most severe effect of the Chernobyl reactor accident is the psychological effects and mental disorders. It is a fact that a large amount of Post-Traumatic Stress Disorders (PTSD) have appeared with symptoms such as depression, hypochondrias, headache, dizziness, fatigue or chronic tiredness, poor concentration, anxiety, physical and mental exhaustion, feeling of hopelessness, and lack of libido. ***The main reason for this is the LNT-hypothesis which give a rather dark future for all involved which have attained an extra radiation dose.***

It has also been observed that there is an increased incidence of high blood pressure, alcohol abuse and even suicide. None of these syndromes are caused directly by radiation.

6. One important factor to the psychological effects was the evacuation of large groups of people. It would have been wise to evacuate those near the reactor (Pripyat) – but they should have been brought back. The radiation level is lower than for many high radiation areas around the world.



A consequence of the Chernobyl accident is that millions of people now suffer from psychological effects. The accident has resulted in an increase of "radio-phobia". This needs to be taken seriously. An understanding of radiation and radioactivity combined with the dissemination of properly acquired data will help reduce radio-phobia. An important objective of this book is to increase understanding and provide some of the relevant data.

We are of the opinion that knowledge about radioactivity, how to calculate radiation doses, and how to compare doses from accidents with doses from natural radiation, medical use and air-travel is of considerable value to the public. Those who exaggerate the fear of radiation need to take responsibility for increasing radio-phobia and the damage spawned by radio-phobia.

For a summary see: <http://chernobyl.undp.org/english/docs/chernobyl.pdf>

Fukushima Japan 2011

On March 11, 2011 an earthquake, of the order 9.0 on the Richter scale, occurred off the north-east coast of Japan and the tsunami that followed killed about 19 000. The height of the tsunami varied considerably and maximum has been calculated to 127 feet.

The Japanese reactors, including the Fukushima Daiichi reactors were automatically shut down by the earth quake. The reactor site in Fukushima included 6 reactors (built in the period 1967 – 1973). Units 4, 5 and 6 had been shut down prior to the earthquake for planned maintenance. The heat of the fuel was cooled with power from emergency generators. The subsequent destructive tsunami with waves of up to 15 meters (the reactors were designed to handle up to 6 meters) disabled the emergency generators that should cool the reactors. Over the following three weeks there was evidence of meltdowns in units 1, 2 and 3. Visible explosions, suspected to be caused by hydrogen gas, in units 1 and 3 may have damaged the primary containment vessel with an uncovering of the spent fuel pools.



Fukushima before the tsunami

Radioactivity was released (mainly I-131 and the cesium isotopes (Cs-137 and CS-134) to the environment. We do not know the total release of isotopes, but it has been suggested to be about 10 % of the release from Chernobyl. In August 2011, the Nuclear Safety Commission (NSC) of Japan published the following results for the total amount of radioactive materials released into the air during the accident at Fukushima. The total amounts released between March 11 and April 5 were $130 \cdot 10^{15}$ Bq (130 pBq) I-131 and $11 \cdot 10^{15}$ Bq Cs-137. This is approximately 10 % of the Chernobyl release.

Falloutmap

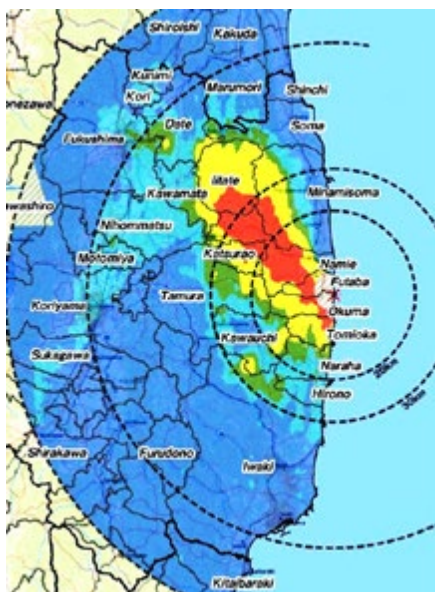

The release to air resulted in fallout to regions near the reactor. An attempt to give the fallout for the Cs-isotopes is given in the map to the left. The yellow and red colors indicate areas with the largest fallout. It is mainly in a narrow region up to about 40 km to the northeast. The exposure level in these areas resulted in evacuation of about 150 000 people.

A large amount of activity was also released to the sea. This activity, which is diluted in the ocean is of minor effect. Some restrictions was introduced for the local fishermen.

A large amount of measurements has been carried out with the purpose to determine doses. Unfortunately all measurements are given as $\mu \text{ Sv/h}$ which is meaningless as a measure of the radiation level. Since it is γ -radiation (low LET) the measurements are numerical equal to $\mu \text{ Gy/h}$ exposure dose.

Both ionization chambers and scintillation dosimeters have been used. Most measurements yield the exposure rate 1 meter above ground. We shall give some maps and follow the decay of radiation during the first two years after the accident.

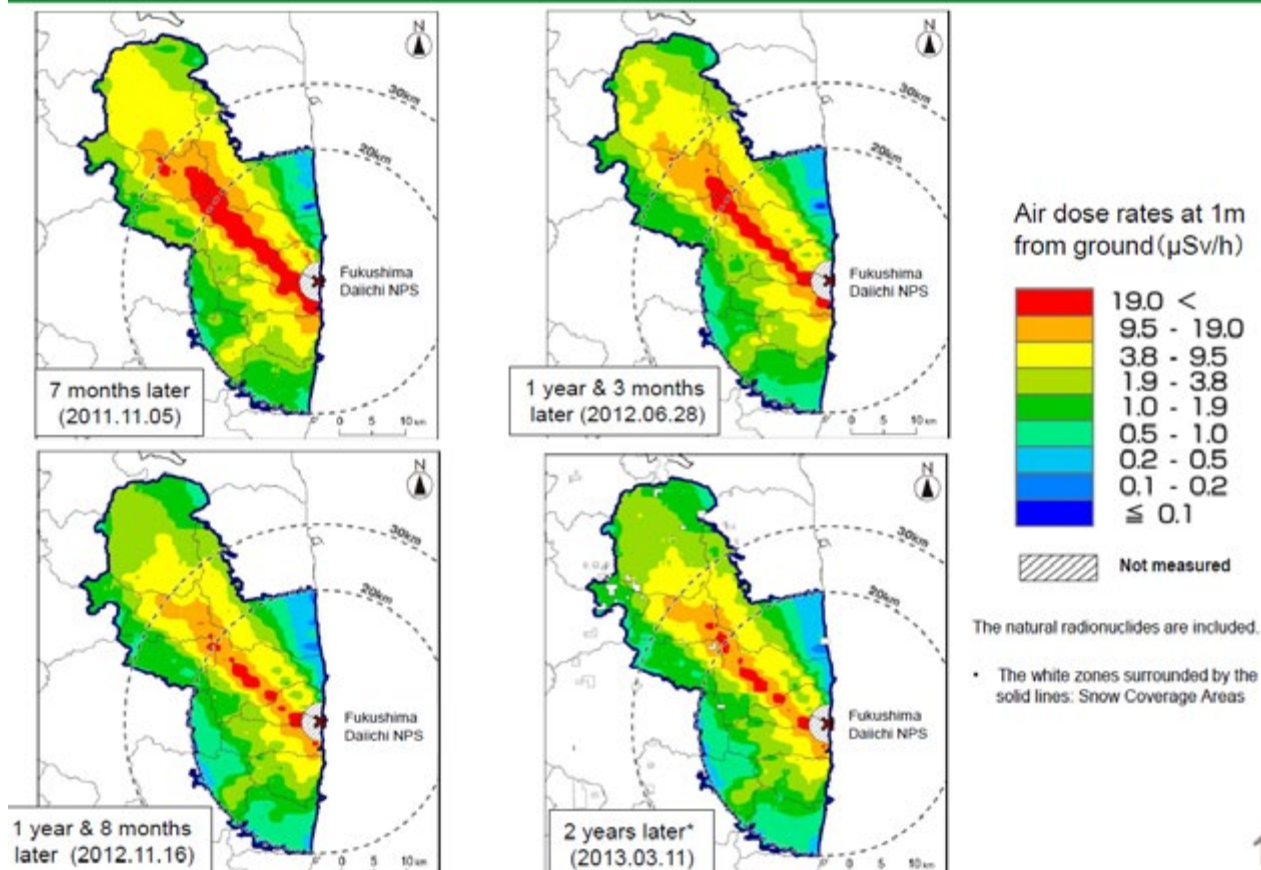

10

Japan's Nuclear Regulation Authority (NRA) has revealed the most contaminated areas in the Fukushima evacuation zone by these maps. The radiation intensity is given by colors with red as the most intense. The measurements are made 1 m above ground and only the external γ -radiation is measured. It is the natural γ -irradiation and the γ -radiation from the Cs-isotopes. As you remember this radiation has an energy of 0.66 MeV.

The measurements are in this original figure expressed in $\mu\text{Sv/h}$ (see the color codes), which is rather confusing and impossible. Here we are concerned with low LET γ -radiation (radiation weight factor is 1.0) and Gy is equal to Sv values.

The exposure dose rate during the first year decayed by about 40%. The decay is quite rapid in the beginning due to the fact that Cs-134 has a half-life of 2 years. However, the Cs-137 will be in the area for decades.

Whole body doses

An interesting question is the whole body dose to a person living in the contaminated area. The average whole body dose would be smaller than the skin exposure dose. The g-radiation from Cs has a half value layer in tissue of about 9 cm. The Ce-radiation is coming from the ground and the dose to the upper part of the body would be smaller.

If a person lived in the area, a large part of the time he/her would be inside buildings with a reduced exposure level. It is very difficult to give a value for the annual dose. Let us assume a person is living in the yellow area for a year (exposure rate 3.8 – 9.5 $\mu\text{Gy/h}$). The maximum dose in open air would be 30 – 83 mSv. A normal life, being indoor and may be out of the zone for some time, would reduce the annual dose by about 50%. This dose, which is far above the Japanese average can be compared to some of the high dose areas discussed on pages 97 – 99.

Radioactivity in the food products

Food monitoring data were reported from 19 to 31 May by the Ministry of Health, Labour and Welfare for a total of 818 samples collected in 18 different prefectures. Most of the monitoring continues to be concentrated in Fukushima prefecture, where 328 out of the 818 samples (over 40%) were collected.

Analytical results for 766 samples (over 93%) of the 818 samples indicated that Cs-134 and Cs-137 or I-131 were either *not* detected or were *below* the regulation values set by the Japanese authorities (500 Bqkg^{-1}). However, 52 samples were above the regulation values for radioactive cesium and/or iodine. In Fukushima prefecture, five samples of fishery products collected on 16 and 17 May; one sample of unprocessed tea leaves collected on 17 May; three samples of shiitake mushrooms and nine samples of bamboo shoots collected on 19 May; five samples of seafood collected on 20, 21 and 23 May, and; one sample of Japanese apricot, two samples of shiitake mushrooms and seven samples of bamboo shoots collected on 26 May were above the regulation values for Cs-134/Cs-137. One sample of algae collected on 21 May was also above the regulation values for Cs-134/Cs-137 and I-131. These measurements have continued and in the end of July 2013 the activity has dropped by a factor of 5. The food products contained below 25 Bqkg^{-1}

Conclusion

The above results are surprising. After Chernobyl we measured up to $100\,000 \text{ Bqkg}^{-1}$ in meat in Norway, and if the release of isotopes was about 10 % of the Chernobyl release we would expect much larger values. One reason may be that the majority of the release went to the sea.

Ecological half lives – mainly Cs-137



In connection with fallouts from reactor accidents it is important to gain information about the ecological half lives in order to live and work in a fallout area. In combination with the fallout from atomic bomb experiments in the atmosphere we found an ecological half-life of about 6 years for Cs-137 in reindeer meat (page 140). The same half life was found for the Laplanders eating the reindeer meet. For a Stockholm group the ecological half life was only 3.5 years (page 141).

The work by J.E. Brittain and coworkers (page 154) with the fallout from Chernobyl is very interesting in this connection. They found that the ecological half life for Cs-137 in brown trout in a fallout region (130 kBq m^{-2}) was about 3.5 years for the first 5 – 6 years, and then increased and seems now to be close to the physical half life (30 years). However, during the first 25 years after the Chernobyl accident (almost 1 half life for Cs-137) the activity has decreased by a factor of about 18.

Information about ecological half lives is important with regard to use and live in fallout areas.

Summing up

The tsunami in March 2011 killed about 19 000 people and destroyed 120 000 buildings and damaged more than 200 000. However, it was the Fukushima reactors that very soon overshadowed all news. The nuclear accident was eventually classified at Level 7, the highest on the International Nuclear and Radiological Event Scale (INES).

No radiation-related deaths or acute effects have been observed among nearly 25,000 workers involved. The thyroid doses from iodine-131 ranged up to several tens of milligray and were received within a few weeks after the accident. The whole-body (or effective) doses mainly from caesium-134 and caesium-137 ranged up to ten or so milligray. The additional exposures received by most Japanese people in the first year and subsequent years due to the radioactive releases from the accident are less than the doses received from natural background radiation (which is about 2.1 mSv per year). Approximately 150 000 people were removed from the fallout area. If the LNT-theory is used it can be calculated how many mansievert this group have avoided – and consequently avoided some cancers. On the other side this removal introduces mental health problems.

Conclusions for Fukushima

Environment: Since the earthquake, a powerful movement gained momentum to halt Japan's use of nuclear energy, which provided 30 percent of the country's electricity. Japan has therefore had to increase its imports of natural gas, low-sulfur crude oil and fuel oil at a substantial economic and environmental cost. Seventy-five percent of the country's electricity now comes from fossil fuels.

Health: The reactor accident after the earthquake and tsunami scared the people far more than the tsunami itself. The main reason for this is again the LNT-theory. The theory with its ALARA principle neglect all other effects of radiation – in particular the positive effects discovered during the last 30 years.

WHO still assume the LNT-theory, whereas UNSCEAR reflects a view that is more doubtful to LNT. Thus in May 2013 they state; "Radiation exposure following the nuclear accident at Fukushima-Daiichi did not cause any immediate health effects. It is unlikely to be able to attribute any health effects in the future among the general public and the vast majority of workers,"

Furthermore; ***the Scientific Committee does not recommend multiplying very low doses by large numbers of individuals to estimate numbers of radiation-induced health effects within a population exposed to incremental doses at levels equivalent to or lower than natural background levels.***

Last comment: It is a pity that all dose measurements – in particular exposure doses are given in the Sv-system. Even WHO use this system.

Application of radiation in medicine

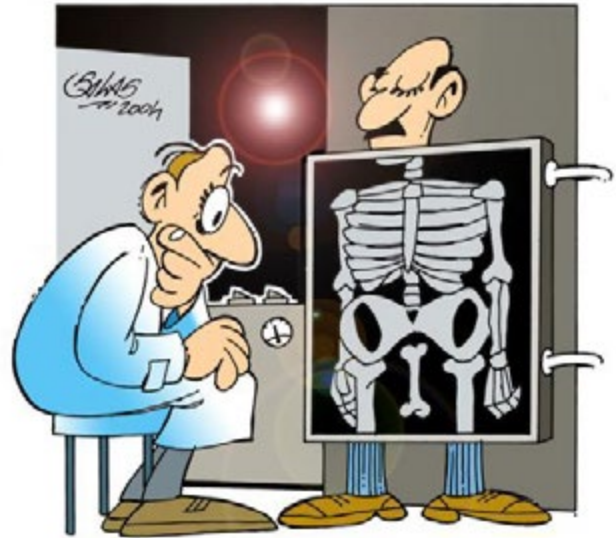

Chapter 9

Radiation used for diagnostic purposes

In this chapter we shall discuss the use of radiation of different kind for medical imaging. This include ordinary x-ray film, the use of contrast media, fluorescent screens, image intensifiers, CT and the use of digital technology to all x-ray systems. In the case of x-rays the source is on the outside of the patient and the detector is on the other side – unless in the case of backscattered x-rays.

We also intend to look in more detail into the use of radioactive isotopes for diagnostic purposes. When isotopes are used, it is always the γ -radiation that gives the information. Furthermore, the isotopes are inside the body – and it is the γ -photons coming out that yield the information. Two types of information are obtained; a). Information about where the isotopes are localized, b). Whether the distribution of activity deviates from normal in an organ or part of the body. We shall give the development of nuclear medicine including the PET-technique.

Both x-rays and isotopes will give a radiation dose to the patient. The doses are rather small, – and should not be of any concern – unless the LNT hypothesis and collective doses are used.

In order to complete the diagnostic field we shall mention a couple of other methods such as magnetic resonance (MR or MRI) and ultrasound. In the case of MR electromagnetic radiation is used in combination with a strong magnetic field. The electromagnetic radiation is within the radio frequency field and can not ionize.

Ultrasound is sound waves with a frequency above 20 kHz.

History of x-ray pictures

The first x-ray picture was taken three days before Christmas 1895 when C. W. Roentgen brought his wife into his laboratory, and they emerged with a photograph of the bones in her hand and of the ring on her finger (the picture is shown below).

Roentgen presented the news on the 28th of December 1895 and the discovery was spread rapidly around the world. About a month later, 23 January 1896, he gave a lecture on the new rays to the Physical Medical Society of Würzburg. During the meeting Roentgen took an X-ray photograph of the hand of the anatomist A. von Kölliker, who was in the audience (see picture below). After this had been done, von Kölliker proposed that the new rays should be called “*Roentgen's rays*”, and this suggestion was approved with great enthusiasm by the audience. In Norway and some other countries we use that name.

The development from this first photo was rapid both with regard to technology and use. We shall give a short history of the development that resulted in sharper and much better pictures.

In an ordinary x-ray photo the object is placed between the x-ray source and the detector (for example film). The picture is based on the x-rays that penetrate the object and hit the detector – and yields the *electron density in the object*.

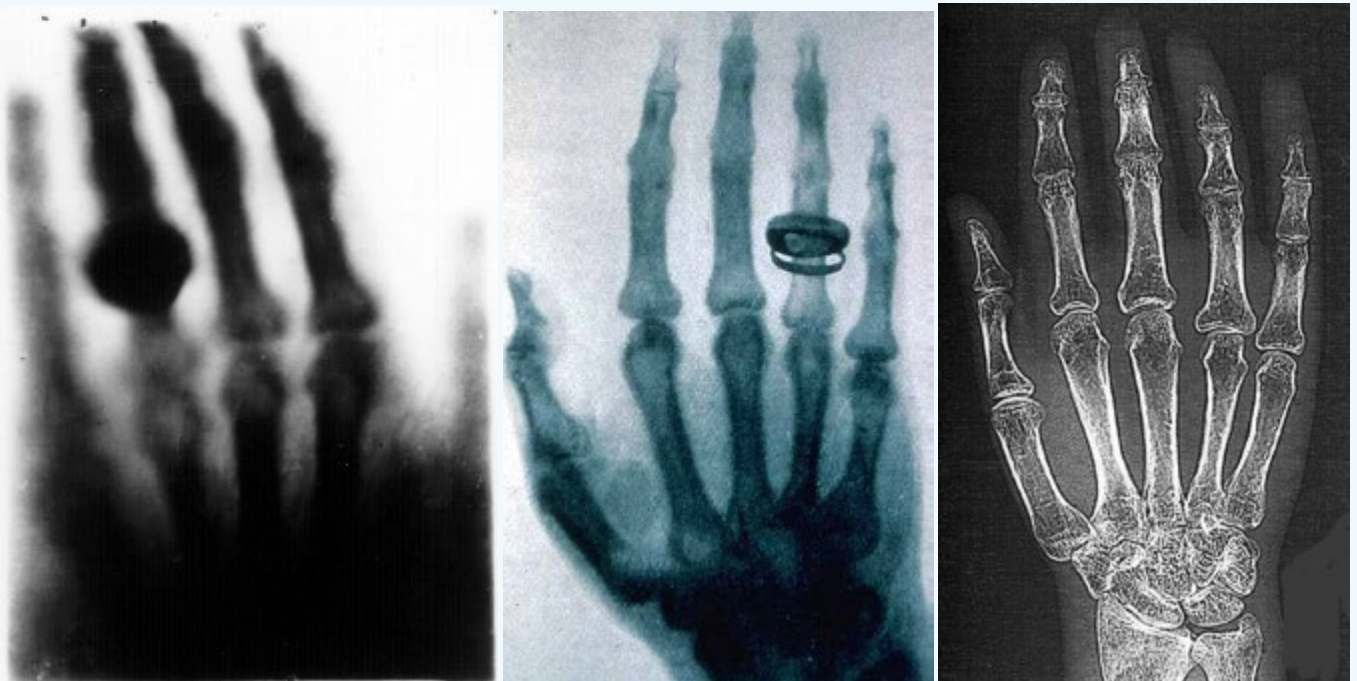

Here we present three pictures of a hand. The two of them are the two first and famous pictures of Mrs. Roentgen (left), von Kölliker (middle). The first one is taken 22. December 1895 and the second one 23 January 1896. You clearly see the improvements. The last one is observed using a digital filter to enhance the details and reduce the noise.

Nikola Tesla and his pictures – shadowgraphs

In the years before 1900 a number of other physicists worked with equipment similar to that of Roentgen. In particular we would like to mention the multigenius Nikola Tesla. He discovered what he called “*shadowgraphs*” – which in fact was x-ray pictures. The famous one of a foot and shoe is shown here.

Nikola Tesla was born in Croatia and emigrated to USA in 1884. He is frequently cited as one of the most important contributors to the birth of commercial electricity and is known for his many revolutionary developments in the field of electromagnetism in the late 19th and early 20th centuries. We can mention that he designed the first hydroelectric power plant in Niagara Falls in 1895.

Nikola Tesla invented his own vacuum tube which had only one electrode. Electrons were emitted and accelerated by the electrical field in his “Tesla coil”. When the electrons hit the glass walls, x-rays were produced. Tesla managed to obtain images of the human body with this radiation – the shadowgraphs.

He also sent some of his images to Roentgen shortly after Roentgen published his discovery. Tesla gave Roentgen full credit for the finding and never attempted to proclaim priority. Roentgen, on the other hand, congratulated Tesla for his sophisticated images.

In the magazine “Electrical Review” for 1896 some X-ray observations by Tesla were published. He described some clinical benefits of x-rays – for example; determination of foreign body position and detection of lung diseases. He noted that denser bodies were more opaque to the rays. Tesla even discovered reflected x-rays which recently has been used (see later).

Nikola Tesla has been honoured by calling the SI unit for magnetic field (also known as “magnetic flux density) for “tesla” (abbreviated T). We shall meet this within the field of MR.

Nikola Tesla s famous picture.



Nikola Tesla
(1856 – 1943)

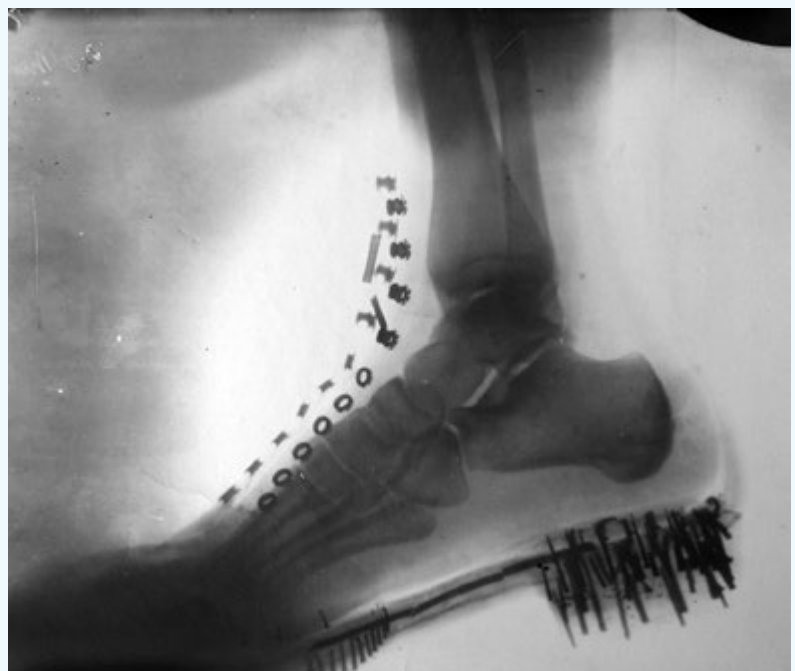

Some of the highlights for x-ray diagnostic

We shall first mention some of the developments in chronological order.

1900

The use of chest x-ray made possible the early detection of tuberculosis. Furthermore, during the next 50 years x-ray pictures and fluoroscopy played an important role in the treatment of tuberculosis. In the period before streptomycin (1947) the only treatment was pneumothorax – an attempt to let the lung rest by accumulation of air in the pleural cavity – and the lung more or less collapsed. The air was absorbed within a couple of weeks and new air was filled in. In order to control this treatment fluoroscopy was used. The patient was x-rayed both before and after a filling. The treatment usually lasted for 2 – 3 years and the doses could be quite large. We can note that no dosimetry was carried out at the time – and the doses now quoted are very much speculations (see page 210).

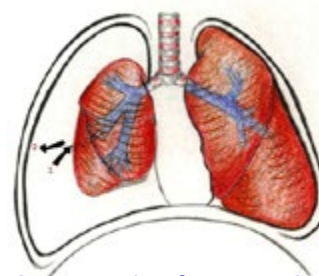

An example of pneumothorax.
Air compress the lung

1906 – 1912

X-ray contrast medium was introduced. The idea was to introduce elements that could absorb efficiently the x-rays and thus enhance the contrast. An x-ray picture yields the electron density of the exposed object. The main absorption mechanism is the photoelectric effect – which varies considerably with the atomic number (approximately as Z^4). In a complex mixture of elements like that found in the organs of a patient, the degree of attenuation varies with the *average* of the atomic number of all the atoms involved. If two organs have similar densities and similar average atomic numbers, it is not possible to distinguish them on a radiograph, because no natural contrast exists. This situation commonly occurs in diagnostic radiography. For example, it is not possible to identify blood vessels within an organ, or to demonstrate the internal structure of the kidney, without artificially altering the electron density and absorption. Consequently, contrast compounds were introduced.

Different iodine (iodine has atomic number 53) compounds have been used as well as BaSO_4 (barium has atomic number 56). Up to about 1950 Thorotrast (ThO_2) was used. Thorium has atomic number 90. Since Thorium is radioactive, ThO_2 was forbidden. In the period from 1931 until it was stopped 2 – 10 million patients worldwide have been treated with Thorotrast.

The first image using contrast was of the renal system (kidneys) in 1906. In 1910 barium sulfate was introduced as contrast agent for gastrointestinal diagnosis. In 1924 the first imaging of the gallbladder, bile duct and blood vessels took place.

1913

The single most important event in the progress of radiology was the invention made by William Coolidge in 1913 when he introduced the Coolidge x-ray tube.

This tube was superior to other tubes at the time because of; 1) its high vacuum and 2) a heated filament as the source for electrons.

The result was a more brilliant x-ray source.



1929

Cardiac catheterization was first performed by Werner Forssmann on himself. He was able to show that a narrow catheter could be advanced from a vein in the arm into the right atrium of the heart, a distance of almost two-thirds of a meter. Obviously, this constituted a remarkable advance – and could be visualized by contrast compounds. W. Forssmann was awarded the Nobel Prize for Physiology or Medicine in 1956.



Werner Forssman
(1904 – 1979)

1955

The x-ray image intensifier was developed. It allowed the pick up and display of the x-ray movie using a TV camera and monitor. By the 1960's, the fluorescent system was largely replaced by the image intensifier/TV combination. This opened the way for angiography which allowed the routine imaging of blood vessels and the heart.

1970

X-ray mammography finds widespread application in imaging the breasts. We shall return to this.

1972

Computed Tomography (CT) scanning was invented by Godfrey Hounsfield and Allan Cormack. In connection to this “break-through” in medical imaging we have to mention the forerunner of the technique called “*planigraphy*”.

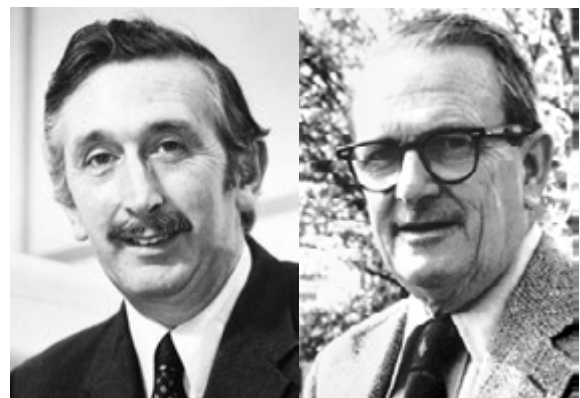

Godfrey Hounsfield Allan Cormack
(1919 – 2004) (1924 – 1998)
Nobel prize in 1979

In 1948 Marius Kolsrud at the University of Oslo presented a master thesis with the title;

Røntgen-skikt-avbildning. Eksperimentelle og teoretiske undersøkelser. Translated this is; “*X-ray tomography. Experimental and theoretical studies*”.

Kolsrud made equipment that made it possible to take x-ray pictures of a single plane in the object. The X-ray source and the film moved in opposite directions during the exposure. Consequently, structures in the focal plane appear sharper, while structures in other planes appear blurred. It is thus possible to select different focal planes which contain the structures of interest. Kolsrud made experiments with a sphere and a piece of barbed wire.

This method was used for chest x-ray pictures in connection with tuberculosis for a number of years. Since a large number of pictures was necessary in order to scan through the lung, the total doses to the patients were rather large – larger than a CT scan.



Marius Kolsrud
1919 – 2007
Prof. in theoretical physics at UiO

1976

Coronary angioplasty was introduced by surgeon Andreas Gruentzig at the University Hospital, Zurich, Switzerland. This technique uses x-ray fluoroscopy to guide the compression of plaques and minimize the dangerous constriction of the heart vessels.



Andreas Gruentzig
(1939 – 1985)

1978

The start of digital radiography. The signal from the x-ray system is converted to a digital picture which can then be enhanced for clearer diagnosis and stored digitally for future review.

1984

Three-dimensional image processing using digital computers and CT or MR data, three dimensional images of bones and organs were first made.

The physical basis for an x-ray picture

The x-ray picture is a shadow picture of the part of the body that is between the x-ray tube and the film. Only the x-ray photons that penetrate the object and reach the film can give a signal or blackening of the film. We do not see the photons that are absorbed or scattered.

To see into the body we must have “something” that can penetrate the body – come out again – and give information. The figure below is an attempt to illustrate the main points for making an x-ray photo.

The two drawings – one vertical and one horizontal – are attempts to illustrate the basic principles for an x-ray photo. Important issues to discuss are;

1. The x-ray source,
2. The absorption and scattering in the body,
3. The detector system.

Labels in the diagram include: Incoming x-ray photons, Part of the body, The x-rays is absorbed according to the electron density, Detector, film, fluoeresent screen, etc., Absorber, Electron, Incoming photons, Transmitted photons, and Scattered photons.

1. The x-ray source

On page 8 we described the basic principles for the formation of x-rays – or rather bremsstrahlung. When electrons with high energy smash into the “anticathode” – a tiny part of the energy is transformed into radiation. This implies that the x-ray photons formed, may have a number of different energies – in fact a whole spectrum is formed (the “Initial spectrum” in the figure below).

X-rays are usually described by their maximum energy, which is determined by the voltage between the electrodes. In x-ray diagnostic the maximum is in the range from 20 kV up to about 120 kV. The x-ray spectrum can be illustrated by the following figure.

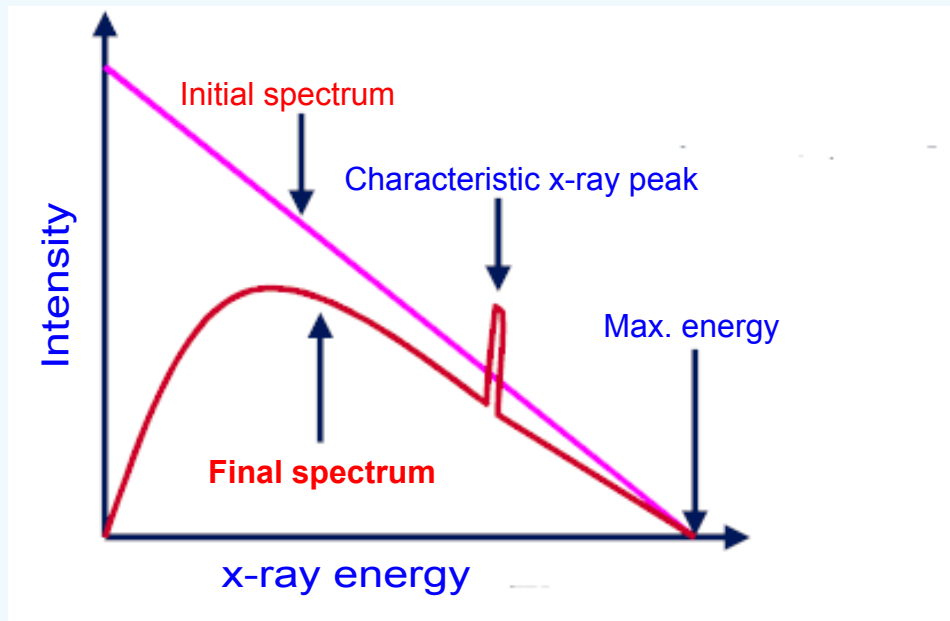

Here is given some details of the radiation from an ordinary x-ray tube. The amount or fraction of the electron energy that is transformed into x-rays from the anode surface is only about a percent of the electron energy. This implies that most of the energy is dissipated as heat, and consequently the anode must be cooled. The probability for transferring the electron energy into radiation is proportional to $Z \cdot E^2$

Here Z is the atomic number of the anode and E is the electron energy. The result is a spectrum – in the figure called “initial spectrum”

In order to use the radiation it must get out of the X-ray tube. The window absorbs some radiation – mainly in the low energy part. The spectrum changes like that illustrated above – from the “initial spectrum” into the “final spectrum”.

The absorption by the window depends on the composition of the window. For example, if low energy x-rays are needed, a beryllium window is used since this window has much lower density than a glass window.

The spectrum also contains characteristic x-rays from dislodging of K- and L-shell electrons from the target. This will not be further discussed when the x-rays are used for diagnostic purposes, but is important for x-ray crystallography.

The maximum energy can be changed according to the purpose. It is in the range from 20 – 120 keV.

A lot of technological improvements have been made with regard to the x-ray source – probably the most important by William Coolidge – which resulted in stronger (more brilliant) and stable sources.

We are not going to describe all the technological developments with regard to the control of the exposure time – and equipment for the different types of examinations. The maximum energy used, depends upon the type of examination. Thus, in the case of mammography the maximum energy is low (below 30 kV) whereas in skeletal and abdominal examinations the energy is larger, between 60 to 85 kV.

Another aspect is that the radiation dose in an examination should be kept as low as possible. Several developments – using intensifying screens have reduced the exposure (see below).

2. Absorption and scattering in the body

The x-ray picture is based on the radiation that penetrates the body and hit the detector (film). The details in the picture are due to those photons that are absorbed or scattered in the body. Since both the absorption and the scattering depend upon the electrons in the object (body) we can say that;

“the x-ray picture is a shadow-picture of the electron density in the body.”

On page 30 we discussed the mechanisms for the absorption of x- and γ -rays in matter. Since x-ray diagnostic uses low energy radiation only the *“photoelectric effect”* and the *“Compton scattering”* contribute to the absorption.

The photoelectric effect occur with bound electrons, whereas the Compton process occur with free or loosely bound electrons. Both processes vary with the radiation energy and the atomic number of the absorber.

Photoelectric effect – variation with photon energy

For the energy region in question – and for atoms like those found in tissue the photoelectric cross-section varies with E^{-3} . Thus, it is a rapid decrease with the energy in this region.

Photoelectric effect – variation with atomic number

The variation with the atomic number is quite complicated. For an energy above the absorption edge, the cross-section per atom varies as Z^4 (i.e. the cross-section per electron varies as Z^3). It can be noted that the K-shell energy for all atoms in the body (C, N, O, P, and Ca) is below 4 keV. Consequently, for the diagnostic purposes the absorption varies with Z^4 per atom.

Compton effect – variation with photon energy

For the energy range used for diagnostic purposes the Compton effect is rather constant – and decreases slightly with the energy. Compton scattering is most important for energies above 60 keV. For lower energies the photoelectric effect is by far the most important.

Compton effect – variation with atomic number

The Compton process increases with the electron density of the absorber. This implies that it is almost independent of the atomic number Z .

Conclusion

1. The absorption processes are the photoelectric effect and the Compton scattering.
2. Photoelectric effect depends strongly on the atomic number (Z^4). This implies that the absorption in bones (with an effective atomic number of about 13) is much larger than that for tissue (with effective atomic number of about 7.5). For energies below about 30 keV the absorption is mainly by the photoelectric effect. In this energy region it is possible to see the small variations in electron density in normal and pathological tissue like that found in a breast.

It can be noted that due to the strong dependence of the photoelectric effect with the atomic number we find the key to the use of contrast compounds. Thus, compounds containing iodine ($Z = 53$) or barium ($Z = 56$) will absorb the low energy x-rays very efficiently. In angiography the arteries becomes visible when iodine compounds are used.

3. The Compton process varies slightly with the energy in this range – and is the dominating absorption process for energies above 50 keV.

4. In addition to the absorption processes some photons will be scattered, i.e. elastic scattering. In *Rayleigh scattering* the photon interacts with a bound electron and is scattered without loss of energy. The probability of this scattering process is proportional to Z^2/E . In *Thomson scattering* the photon interacts with a free electron and the radiation is scattered in all directions. The two elastic scattering processes accounts for less than 10 % of the interactions in the diagnostic energy range.



The purpose for discussing these details about absorption and scattering is to give some background knowledge of the physics of the x-ray picture.

It is differential attenuation of photons in the body that produces the contrast which is responsible for the information. The attenuation of the radiation in the body depends upon; the density, the atomic number and the radiation quality. The absorption of x-rays decreases as the energy (kV) increases.

In mammography one are interested in visualizing small differences in soft tissue – and we use low energy x-rays (26 – 28 kV) to enhance the tissue details.

In the case of chest pictures the peak energy must be larger because the absorbing body is very much larger – and some radiation must penetrate the body and reach the detector.

It is the transmitted photons that reach the detector that are responsible for the picture.

3. The detector system

A number of different detectors (film, ionization chambers, luminescence and semiconductors) have been used since the beginning of x-ray diagnostic.

For a very long time film was used. The x-ray picture was created when the radiation was absorbed in the film emulsion consisting of silver halides (AgBr as well as AgCl and AgI).

The emulsion was suspended on gelatin as the supporting medium.

In the usual morning meeting the doctors were often gathered in front of the “light box” to discuss the patients (see illustration).



The absorption in the thin film emulsion is very small. Consequently, in order to increase the sensitivity, intensifying screens were introduced. The screen is usually a phosphor scintillator that converts the x-ray photons to visible light that in turn expose the film. The introduction of intensifying screens was made already in 1896 by Thomas Alva Edison. He introduced the calcium tungstate screens which were dominating up to the 1970-ties. This material has now largely been replaced by rare-earth metal based screens. We do not intend to go through the technical details with regard to intensifying screens – nor to the many technological details within x-ray diagnostic. However, a few points should be mentioned.

Conventional radiography uses energies between 50 and 80 kV. In order to ensure that the photoelectric effect is dominant lower energies are used. Energies lower than 30 kV are used for mammography – which is very effective for seeing details in soft tissue. However, this energy range is only useful for tissue thicknesses of a few centimeter.

Mammography

In mammography the goal is to see the contrast between different density of soft tissue, fat and blood vessels without use of contrast media. The x-ray energy is between 25 and 30 kV in order to ensure that the photoelectric effect is dominant. This also result in absorption of radiation and an increase of the patient dose.

A typical situation is given in the illustration to the right.

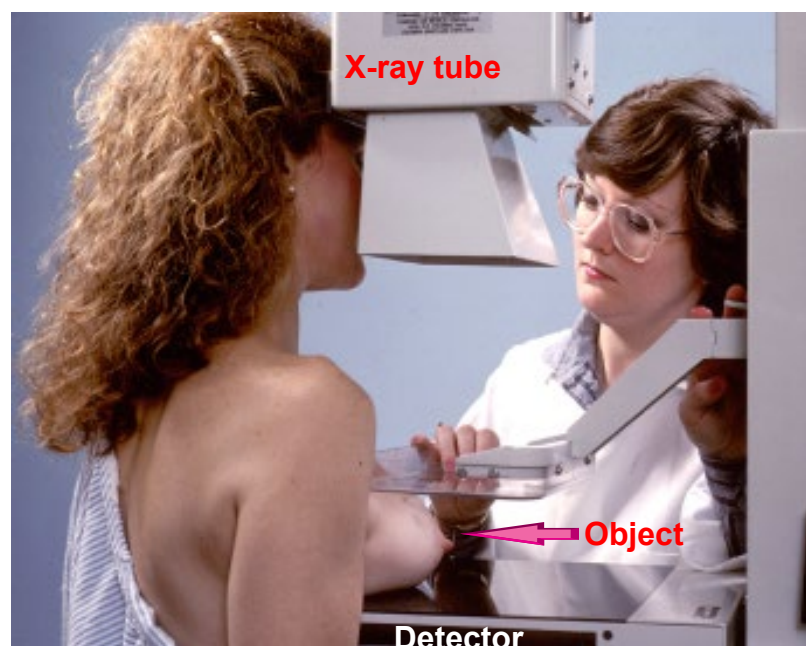

Examples

It is sometimes very convincing to see a mammogram like that shown to the right. It is also amazing that we can see details like this in soft tissue without using contrast media to enhance the difference in electron density.

The next example is shown below. Here you see two mammograms of the same normal breast. The large differences are due to the technique used.

To the left is a modern digital picture whereas the other is a film-based mammography.

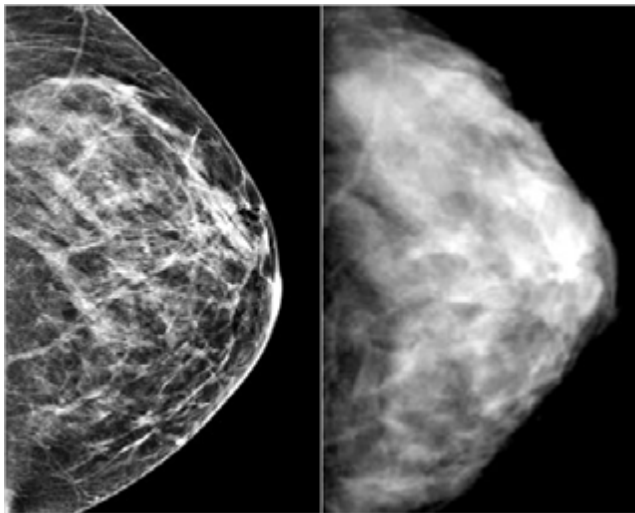

Implants

It is obvious, even for the layman, that the presence of breast implants does interfere and makes it more difficult to obtain good information with mammography.

The presence of implants affects the way mammograms are done, since additional views are needed during routine screening mammography to visualize all of the breast tissue.

Implants also makes it more difficult to interpret in some cases. The lesson to learn from this is that implants could be an impediment to cancer detection.

We can conclude that you have to be well trained to give a good description.

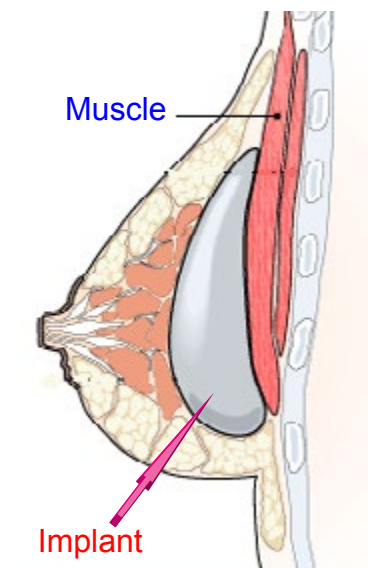

Fluoroscopy

With the ordinary x-ray film it was impossible to see any movements. This became possible by using phosphor screens. The transmitted x-rays caused scintillations that was viewed directly. In order to reduce the dose to the doctors the fluorescent screen was backed by lead glass. The whole examination was performed in a dark room and with adapted eyes. The images were faint and low in contrast. This examination (in Norway known as “gjennomlysning”) was widely used in the treatment of lung tuberculosis and pneumothorax treatment.

The screens were outdated and “image intensifiers” were introduced (see figure). The x-rays were converted to light by using phosphors (CsI:Na) – and again to photoelectrons. They were accelerated and focused on a smaller fluorescent screen which in turn is coupled to a recorder system; for example a video camera or a film camera.

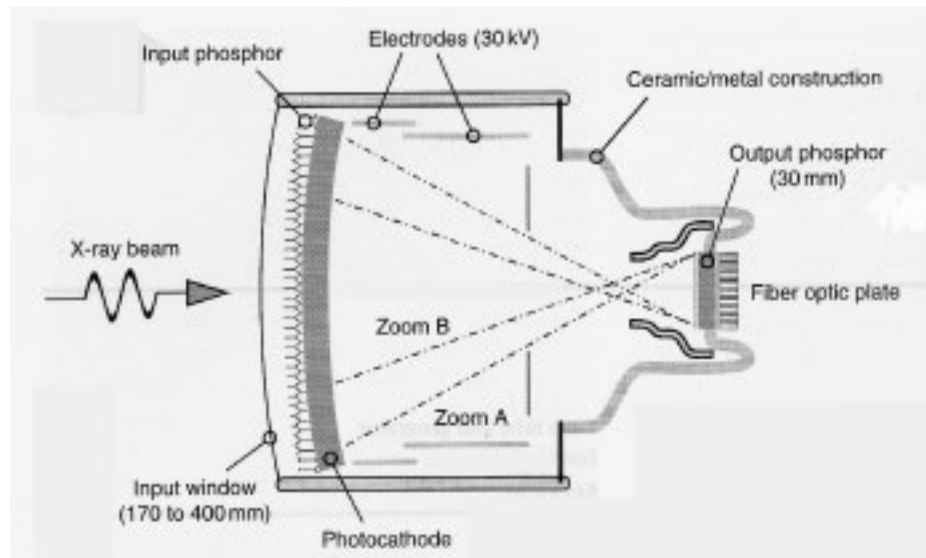

If the technique is coupled with the use of contrast media it is possible to follow the contrast when it is flowing through the blood vessels. It is thus possible to perform some type of treatment while viewing it.

Shoe-fitting fluoroscopy

Today it is almost unbelievable that x-rays was used to find the right pair of shoes. However, during the period 1930 – 1950 an x-ray fluoroscope like the one shown was used.

The system consisted of a vertical wooden cabinet with an opening near the bottom into which the feet were placed. When you looked through one of the three viewing ports on the top of the cabinet (e.g., one for the child being fitted, one for the child’s parent, and the third for the shoe salesman or saleswoman), you would see a fluorescent image of the bones of the feet and the outline of the shoes.



The machines generally used a 50 kV x-ray tube in the bottom of the cabinet. When you put your feet in the opening, you were standing on top of the x-ray tube. The only shielding was a one mm thick aluminum filter.

Measurements made in recent years indicate that the doses to the feet were in the range 0.07 – 0.14 Gy for a 20 second exposure. Doses to the pelvis ranged from 0.03 to 0.17 mGy.

Digital imaging

The technique with digital x-rays was introduced in the 1970's. Analog to digital converters and computers were adapted to conventional fluoroscopic image intensifier systems. Angiographic procedures for looking at the blood vessels in the brain, kidneys, arms and legs, and the blood vessels of the heart all have benefited tremendously from the adaptation of digital technology.

It is reasonable to assume that all of the film systems will be replaced by digital x-ray detectors. The benefits of digital technology can be summarized as follows:

1. The x-ray dose can often be reduced to achieve the same high quality picture.
2. The digital x-ray images can be enhanced and manipulated with computers.
3. The digital images can be sent via network to other computers and hospitals.
4. The digital images can be archived onto compact disks and thus save storage space.
5. The digital images can be retrieved from an archive at any point in the future for reference.

Examples

We have already shown a couple of examples with digital technique.

On page 173 the picture of a hand is shown together with some old film-based pictures.

On page 182 you can see an example with mammography.

To the right is an example with dental x-rays. The image can be enlarged, which makes it easier to detect the problems.



CT – Computer tomography

On page 176 we mentioned that the forerunner to CT was called planigraphy – or linear tomography. Let us therefore look into this technique – which played a role in the treatment of tuberculosis in the 1950s and 1960s.

The technique was proposed early in the 1900s by the Italian radiologist Alessandro Vallebona. In Norway professor Marius Kolsrud constructed an equipment in 1948.

The idea is based on the simple principle of moving synchronously and in opposite directions the X-ray tube and the film. Consequently, structures in the focal plane appear sharper, while structures in other planes appear blurred. The lung was shown – slice by slice – and could yield information about the position and extent of the TB infection. In order to cover a lung about 20 x-ray pictures were required.



Alessandro Vallebona
(1899 – 1987)

The next step was introduced by G. N. Hounsfield and A. M. Cormack in 1972. The CT or CAT scanner was successful since much smaller contrast differences can be observed. They replaced the x-ray film by a group of small detectors. The signals from the detectors were stored and analyzed mathematically in a computer. The computer rapidly reconstructs an image of the examined cross-section.

Scintillation detectors combined with photomultipliers or photo diodes have been used. We would also like to mention the gas detector. This is similar to the Geiger detector. In order to increase the sensitivity the gas detector is filled with pressurized xenon. Xenon is the heavy noble gas with atomic number 54. Consequently, the photoelectric effect is very efficient. An array of several hundred xenon detectors constitute the detection system. Since the detector yields analog voltage pulses they have to be digitized by an ADC converter.

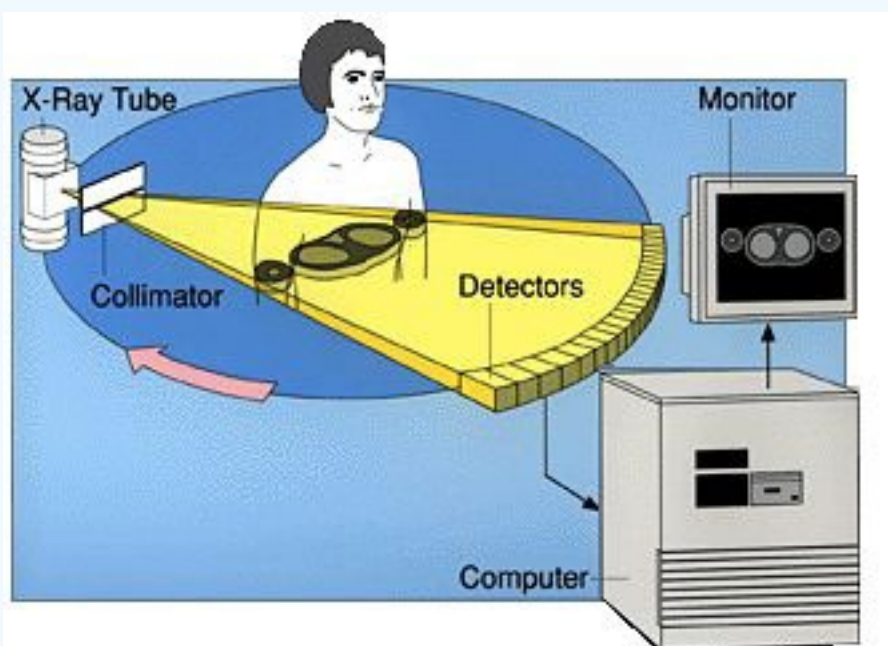

This illustration, taken from Scientific American gives some of the main properties of a CT-scanner. The technique has been rapidly developed since the first scanner presented by Hounsfield in 1972. Both the x-ray tubes, the detector technique as well as the computer presentations with filters etc. have given amazing results.

A CT-scanner you can meet in the hospital

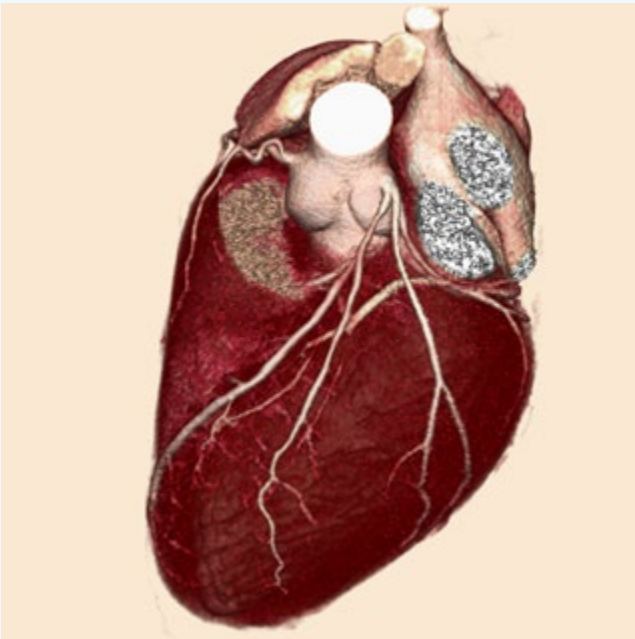

The above pictures – and a lot more – can be found on Internet. The examples show the power of this technique.

You can go to Internet and see a number of excellent pictures; for example see:

<http://www.montclairradiology.com/>

Backscattered X-rays – Compton scattering

On page 9 we presented a couple of cartoons from more than 100 years ago. These cartoons – given again below – represented a misunderstanding at that time and caused a big smile. The misunderstanding was that some people had the idea that it was possible to take x-ray pictures with reflected x-rays – which means that both the x-ray tube and the film was in the photographer’s box (like an ordinary camera). As a result of this some people feared that you could use an x-ray camera to watch people when they changed into swimming suits inside the small cabins on the beach. A London tailor company advertised therefore that they could make *x-ray proof underclothing for ladies*.

Today with the use of Compton backscattering technique all this is a reality – and in fact in use several places for security. Let us therefore give a short glimpse of the technique.



Compton scattering is the key

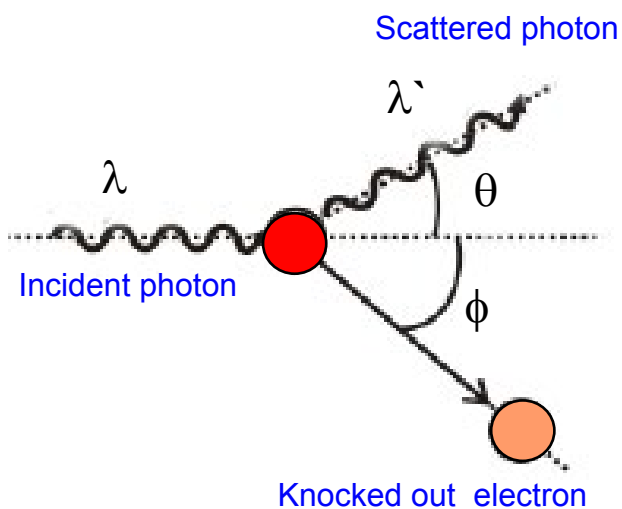

The Compton process is outlined by the figure. It is a reaction between the x-ray photon and a free or loosely bound electron. The scattered photon has a reduced energy. Since both the energy and momentum are conserved it can easily be shown that the energy of the scattered photon, E_s , can be given as a function of the scattering angle θ by the following expression;

$$E_s = \frac{E_\gamma}{1 + \frac{E_\gamma}{m_e c^2} (1 - \cos\theta)}$$

For backscattered photons the angle is approximately 180 degrees. Thus the energy of the backscattered photons is reduced by approximately 30 %. The number of backscattered photons are given by the Klein and Nishina formula.

With the knowledge of backscattered Compton radiation, equipment have been developed for observing objects. The x-ray tube and the detector system is now on the same side of the object. The picture is formed by a pencil-shaped beam of x-rays that is sweeping the object. The energy used is approximately 100 keV (100 – 200 kV tubes) which ensures that the Compton process is dominating.

The resolution is (so far) not as good as for ordinary x-rays, but you can easily see objects with an atomic number different from that for tissue. The technique is worked out for security purposes on airports and other places. It is possible to use the technique to see the contents of a closed container through the container walls.

Below is a few examples taken from Internet.



On Internet you can find a number of backscattered x-ray pictures. The technique is excellent for observing hidden objects on people or the cargo in containers – objects that is not possible to observe with the usual metal detectors..

To the left is a famous picture given in combination with control at airports.

Below is shown an example of control of the cargo in a big truck.



The use of radioactive isotopes

Nuclear medicine

Radioactive isotopes have been used for more than 100 years in medicine – both for radiation therapy (will be discussed in the next chapter) and for diagnostic purposes. About 90% of the medical use of isotopes are for diagnosis. The most common radioisotope used in diagnosis is technetium-99, but a large number of other isotopes are in use. The thyroid, bones, heart, liver and many other organs can be easily imaged, and disorders in their function revealed.

Diagnosis

For diagnostic purposes we use radioactive tracers which emit gamma rays from *within* the body. The isotopes are generally short-lived and linked to chemical compounds which permit specific physiological processes to be studied. They can be given by injection, inhalation or orally.

For a number of years the γ -radiation was observed using a so-called gamma camera. The camera builds up an image from the points from which radiation is emitted. The image can be enhanced by a computer and abnormal conditions can be observed.

A more recent development is Positron Emission Tomography (PET) which is a more precise and sophisticated technique. It is based on positron-emitting nuclides – usually made in a cyclotron. When this nuclide decays, it emits a positron, which promptly combines with a nearby electron resulting in the simultaneous emission of two γ -photons in opposite directions. The detection gives a very precise indication of their origin. With the isotope F-18 as the tracer, it has proven to be the most accurate noninvasive method of detecting and evaluating most cancers. The reason for this is that F-18 can be added to glucose – and the tumors have an increased rate of glucose metabolism compared to benign cells. PET is also used in cardiac and brain imaging.

Isotopes for diagnosis



Let us point out a couple of important requirements for the use of radioisotopes:

1. Only γ -radiation is used for diagnostic purposes. For other purposes i.e. in tracer work, isotopes emitting β -particles can readily be used.
2. The isotopes should have a short half-life for safety reasons and handling. Short in this context is up to a few days.

Due to the requirement of a short half-life mainly or solely *artificially* made isotopes comes into question. This implies that the nuclear medicine started when equipment like the cyclotron and neutron sources like the reactor become available in the 1930s and 1940s.

Some of the highlights in the history of nuclear medicine

We shall first mention some of the developments in chronological order.

1924

This year can be considered as the start point for using radioisotopes as tracers and for biological studies. Georg de Hevesy and coworkers used Pb-210 (one of the isotopes in the Uranium-radium-series) and studied the absorption and elimination of lead, bismuth and thallium salts by animal organisms.

After the start of making radioisotopes in the 1930s O. Chievitz and Georg de Hevesy administered phosphate labeled with P-32 to rats and demonstrated the renewal of the mineral constituents of bone.

George de Hevesy was awarded the Nobel prize in chemistry for his pioneering work with radioactive tracers.



George de Hevesy
(1885 – 1966)

1930s in Berkeley

The University of California in Berkeley has played a significant role in the start and growth of nuclear medicine. In the front of the work carried out in Berkeley are the two Lawrence brothers (Ernest and John) and Glen Seaborg. The Lawrence brothers are of Norwegian heritage and Seaborg is coming from Sweden.

He was awarded the Nobel prize in chemistry for 1943.

“for his work on the use of isotopes as tracers in the study of chemical processes”.

1936

John H. Lawrence, the brother of Ernest, made the first clinical therapeutic application of an artificial radionuclide when he used phosphorus-32 to treat leukemia. Also Joseph Gilbert Hamilton and Robert Spencer Stone administered sodium-24 to a leukemia patient.

1937

John Livingood, Fred Fairbrother and Glenn Seaborg discovered Fe-59 with a half-life of 45 days.

1938

Glenn Seaborg and coworkers discovered I-131 (half-life 8 days) and Co-60 (half-life 5.26 years).

Furthermore, this year Emilio Segrè and Seaborg discovered Tc-99m the metastable (excited) Tc-99 isotope. The metastable isotope has a half-life of 6 hours and emit a γ -photon with energy 140 keV.

Tc-99m is an important isotope and is used in approximately 85 percent of diagnostic imaging procedures in nuclear medicine.



Emilio Segrè
(1905 – 1989)
Nobel prize 1959

Berkeley – the birthplace of nuclear medicine

The key to nuclear medicine is the formation of suitable isotopes.

The development of nuclear accelerators – in particular the cyclotron – made it possible to enter the field of nuclear medicine.

Two scientists are of utmost importance for the construction of the first accelerators; Rolf Widerøe and Ernest Lawrence.

The development of the cyclotron and the beginning of nuclear medicine is closely connected to California and the Berkeley University. It all started when the oldest of the Lawrence brothers (Ernest) came to Berkeley in 1929. He became aware of the ideas included in the doctor degree of Rolf Widerøe. He used the ideas and invented the cyclotron.

In a linear accelerator charged particles are accelerated in tubes forming a straight line. Lawrence arranged this by letting the particles go in larger and larger circles within a box – kept in place by a magnetic field. The first cyclotron from 1931 was only 5 inches in diameter. However it could accelerate protons up to 80 keV. The development from this point was rapid and new isotopes were produced.



Ernest Lawrence
(1901 – 1958)



Rolf Widerøe
(1902 – 1996)

Ernest Lawrence is of Norwegian heritage (grandparents were from Norway). He was the father of the first cyclotrons constructed in Berkeley. He got the Nobel prize in 1939. The Radiation Laboratory in Berkeley are named after him. Furthermore, Lawrence Hall of Science above the UC campus is an exciting public science center with exciting hands-on experiences for learners of all ages.

Rolf Widerøe is Norwegian, born in Oslo. He was engaged in the construction of an accelerator, and published these ideas already in 1923 (21 years old). His name is connected to important accelerators for radiation therapy – such as the linear accelerator, the cyclotron and the betatron. He was behind the first high energy radiation source in Norway – the betatron from 1953 at The Radiumhospital.

Model of a cyclotron



University Of California

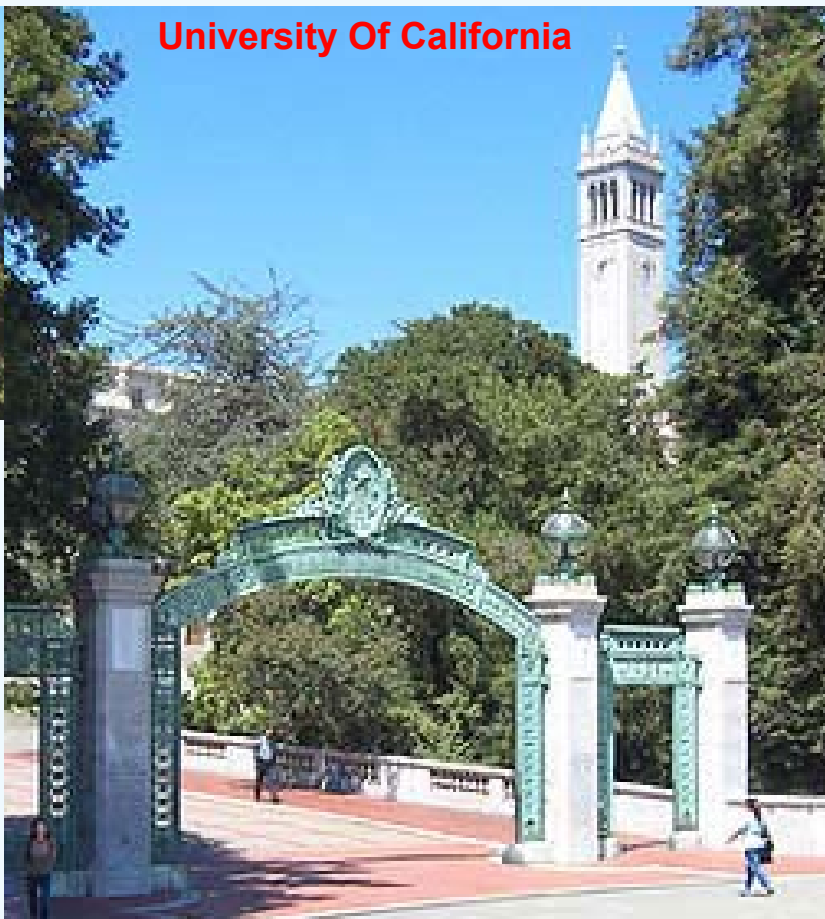

A picture of the campus with its landmarks “Sather Gate” and “Sather Tower”. They are named after Peter Sather (born on Nedre Sæter farm in S-Odal, Norway). He was a banker and a trustee to CAL.

The above picture is a model of a cyclotron – placed near the entrance of “Lawrence Hall of Science” in Berkeley.

The Berkeley University developed a number of accelerators and become the place where new isotopes were produced. The leading scientist in the production of new isotopes and elements was Glenn Seaborg.

Glenn Seaborg
(1912 – 1999)

Glenn Seaborg was a Swedish American (his mother was from Sweden). Seaborg was the principal or co-discoverer of ten elements: plutonium, americium, curium, berkelium, californium, einsteinium, fermium, mendelevium, nobelium and element 106, which was named seaborgium in his honor while he was still living. He also developed more than 100 atomic isotopes, like I-131 and Tc-99m which are important isotopes for medicine.

Seaborg was awarded the Nobel prize for Chemistry in 1951 together with another Berkeley scientist Edwin McMillan.





Hal Anger
(1920 – 2005)

John Lawrence joined his brother Ernest in 1936, and started Donner Laboratory. He used for the first time a radioactive isotope in the treatment of a human disease (leukemia). The two brothers also treated successfully their mother.

John Lawrence became known as the father of nuclear medicine and Donner laboratory is considered the birthplace of this field.

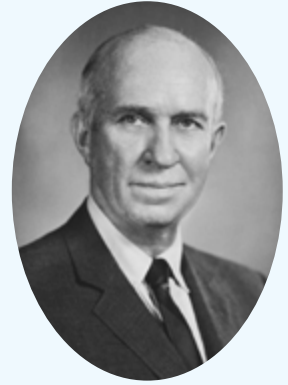

John Lawrence
(1904 – 1991)

Hal Anger (also a Donner man) invented in 1958 the gamma-camera – also called Anger camera. He was awarded the first Cassen Prize in 1994 for his invention.

1958

Hal Anger (above) invented the “scintillation camera,” an imaging device that made it possible to conduct dynamic studies. This is also called “Anger camera” and consisted of a large flat scintillation crystal and a number of photomultipliers.

1959

Rosalyn Yalow and Solomon Berson developed radioimmunoassay (RIA). They used I-131 labeled insulin to measure the reaction between an antigen and antibody. This technique is used widely to study other hormones in the body. Solomon Berson died in 1972. In 1977, Rosalyn Yalow was awarded the Nobel Prize in Medicine for their work.



Rosalyn Yalow
(1921 –)

1962

David Kuhl introduced emission tomography in 1962, leading to the first “computer tomography” which ultimately led to the development of the X-ray CT scanning as well as PET. He is recognized internationally as the “father” of PET scanning.



David Kuhl

Some of the isotopes used in nuclear medicine

The use of radioactive isotopes in research and medicine can be divided in three groups.

1. Isotopes used as tracers

A radioactive isotope attached to an important molecule can tell where it is. The radiation emitted yield the information. Isotopes emitting γ -rays are easily observed, but also pure β -emitters like H-3 (tritium) and C-14 can be used. Thus, Melvin Calvin used C-14 to the exploration of photosynthetic carbon dioxide reduction. He was awarded the Nobel prize in chemistry for 1961 for this work.

The Hershey – Chase experiment

A very well known experiment with radioactive tracers was the Hershey–Chase experiment from 1952.

Alfred Hershey and Martha Chase used the isotopes P-32 (β -emitter with half-life 14 days) and S-35 (β -emitter with half-life 87 days). The first one was built into DNA in the virus T2 phage, whereas S-35 was built into the protein part of the virus.

They studied how the virus infected E. Coli bacteria and could conclude that *the genetic material which infects the bacteria is DNA*.

Numerous experiments within biochemistry and biology use radioactive isotopes as tracers.

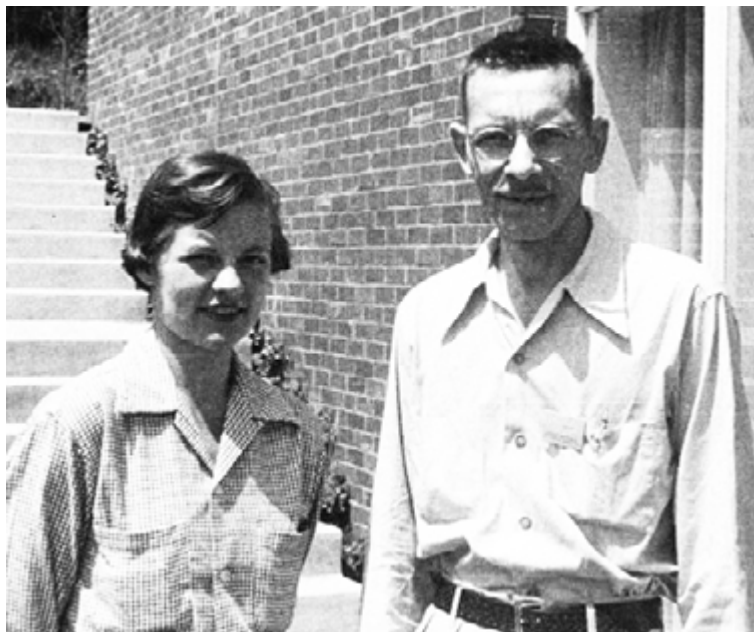

Alfred Hershey (1908 – 1997) was the principal investigator, whereas Martha Chase (1927 – 2003) was the lab. assistant. Hershey got the Nobel prize for the experiment in 1969 together with Delbrück and Luria.

2. Isotopes in radiation therapy

In radiation therapy the purpose is to irradiate cancer cells to death and let the normal cells survive. Radium (Ra-226) was used from the beginning, both for teletherapy and as implants in brachytherapy. Radium was replaced by Co-60 and Ir-192 (see next chapter).

In later years new isotopes like At-211 (half-life 7.2 hours) have been used. Attached to compounds (monoclonal antibodies) the isotope can be transported to the the cancer cells. The isotope emits α -particles (energy 6.8 MeV) which have a short range and a high LET-value. We shall return to this in the next chapter.

3. Isotopes for diagnostic purposes

Several isotopes emitting γ -rays can, and have been used for diagnostic purposes. For example, I-131 will be accumulated in the thyroid and can via a gamma camera give information about sicknesses in the thyroid.

We have pointed out before that the isotope most often used for medical information is Tc-99m. Let us therefore give some details about the isotope – its formation and use.

Tc-99m

In the figure below we have outlined how to make the isotope as well as the physical properties of it. We start with Mo-99, which is a fission product. The decay scheme for Mo-99 contains something new. Thus, after the β -particle emission the newly formed technetium isotope is in a so-called “*meta-stable*” state. This is denoted by a “m” – like Tc-99m. The metastable state implies that the subsequent γ -emission is delayed. If we could isolate this metastable isotope it would be perfect for medical use, since the isotope would only emit a γ -photon with no contamination from β -particles.

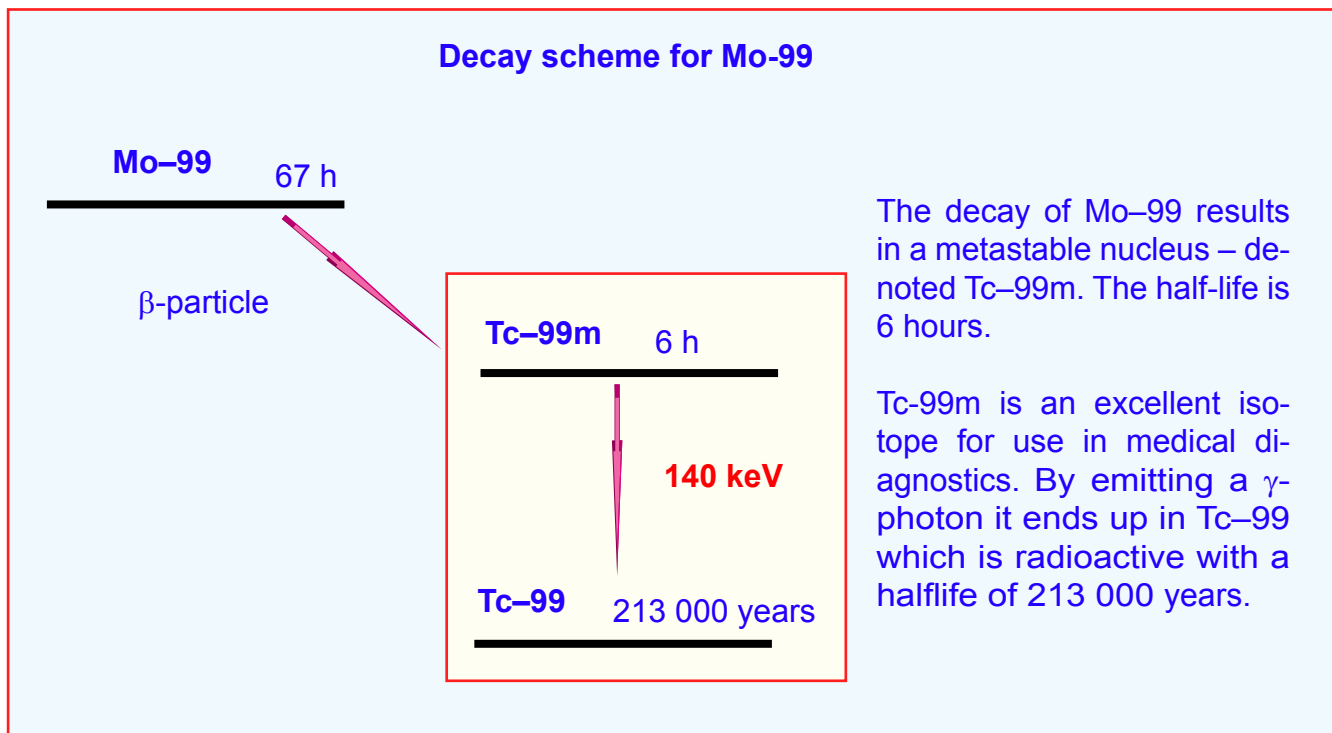

Mo-99 is bound to aluminum-oxide. The half-life is 67 hours. The compound is rinsed with physiological saline, and the Tc-99m that has been formed follows the water – it is like “milking”. The next step is to hook on this isotope to compounds that can bring it to particular places in the body that can be studied. More than 30 compounds based on Tc-99m have been made for imaging and functional studies of the brain, myocardium, thyroid, lungs, liver, gallbladder, kidneys, skeleton, blood and tumors.

Tc-99m emits γ -radiation with an energy of 140 keV, which readily escapes the body and is easily measurable. The distribution of the radioactivity in the body can be measured.

From a physicist's point of view it is probably the technique developed to observe the distribution of radioactivity that is the most interesting – whereas from a medical point of view it is the diagnostic power that is the most interesting.

Ben Cassen and Hal Anger

The technique with the radioactive isotopes in medical diagnostics started in the 1950s when Benedict Cassen invented the rectilinear scanner and in 1958 with the γ -camera (or Anger camera). It was now possible to obtain a picture over the area of interest.



Photo of William H. Blahd

A picture of Hal Anger (1920 – 2005) and Benedict Cassen (1902 – 1972) at the International Conference on Peaceful Uses of Atomic Energy in Geneva, Switzerland, in 1955.

It can be mentioned that the “Society of Nuclear Medicine” every second year since 1994 give out a prize in honor of Benedict Cassen (The Benedict Cassen prize) for outstanding achievements in nuclear medicine.

The illustration to the right demonstrate the technique introduced by Benedict Cassen. He assembled the first automated scanning system that was comprised of a motor driven scintillation detector coupled to a relay printer.

The scanner was used to image the thyroid glands with I -131. After the initial studies, it was an extensive use of the scanning system for thyroid imaging during the early 1950s. Cassen’s development of the rectilinear scanner was a defining event in the evolution of clinical nuclear medicine.

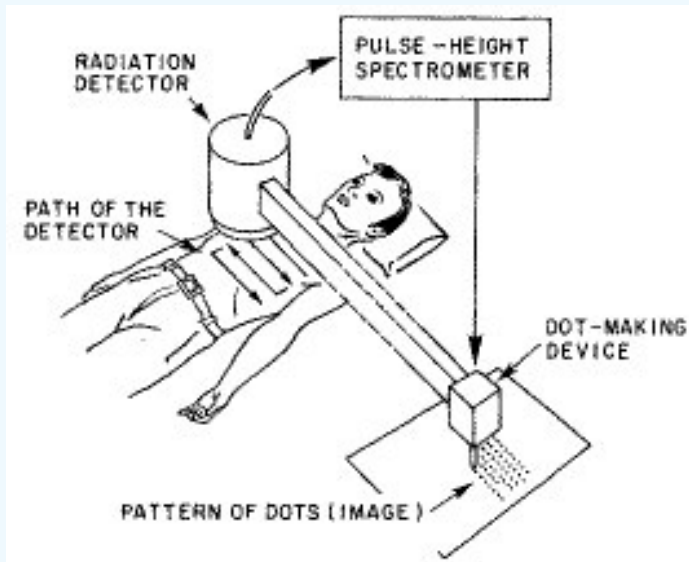

In 1956, Kuhl and his colleagues developed a photographic attachment for the Cassen scanner that improved its sensitivity and resolution. With the development of organ-specific radio pharmaceuticals, a commercial model of this system was widely used during the late 1950s until the early 1970s to scan the major body organs. The decline of the rectilinear photoscanner began in 1973 with the advent of computed axial tomography.

SPECT

SPECT is short for Single Photon Emission Computed Tomography. As its name suggests (single photon emission), ordinary γ -ray emission is the source for the information.

The camera or detector rotates around the patient, and the detector will observe the tracer distribution for a variety of angles. After all these angles have been observed, it is possible to reconstruct a three dimensional view of the isotope distribution within the body. A computer is used to apply a tomographic reconstruction algorithm to the multiple projections, yielding a 3-D dataset. This dataset may then be manipulated to show thin slices along any chosen axis of the body, similar to those obtained from other tomographic techniques, such as CT, PET and MR (or MRI).

An example with Tc-99m

In the example shown (to the right), Tc-99m was added to methylene-diphosphonate, which is absorbed by the bone-forming cells (the osteoblasts). The picture makes it possible to study diseases of the skeleton, such as bone cancer.

The doses to both the patient and the medical personnel are small. The strength of the source used for an examination is around a few hundred million Bq (MBq). In the present example 700 MBq was used.



Courtesy of Arne Skretting,
Norwegian Radium Hospital

PET – Positron Emission Tomography

The development of positron imaging covered decades and included contributions from different scientists. The technique is based on artificially induced isotopes that emits positrons. In order to understand this we refer to chapter 2 where we discussed the different ways an unstable nucleus could attain a more stable state. We mentioned that in the ordinary β -decay, a neutron was transformed into a proton and an electron, which was emitted. This is a favorable reaction since the neutron mass is larger than the proton mass. The opposite reaction where a proton is transformed into a neutron is however, a more difficult process. We can however, attain this goal via two different routes; 1) electron capture and 2) **positron emission**.

For all natural isotopes, electron capture is the usual process – because the energy between the parent and daughter is less than $2m_e c^2$ (m_e is the electron mass). However, for a number of artificially induced isotopes **positron emission takes place**.

The fate of the emitted positron is; after being slowed down, it will meet an electron, and then either annihilate directly, or form a short-lived “positronium atom”.

The final process is an annihilation where the mass of the two particles is transformed into γ -ray photons. Mainly two photons with equal energy, 511 keV, are formed. A very important point is that the photons fly off in opposite directions (see the illustration to the right). This annihilation process represents the basic physical principle for PET. We observe the two photons by detectors 180 degrees apart (coincidence measurements). We know from this observation that the annihilation process has taken place somewhere along the line shown in the illustration.

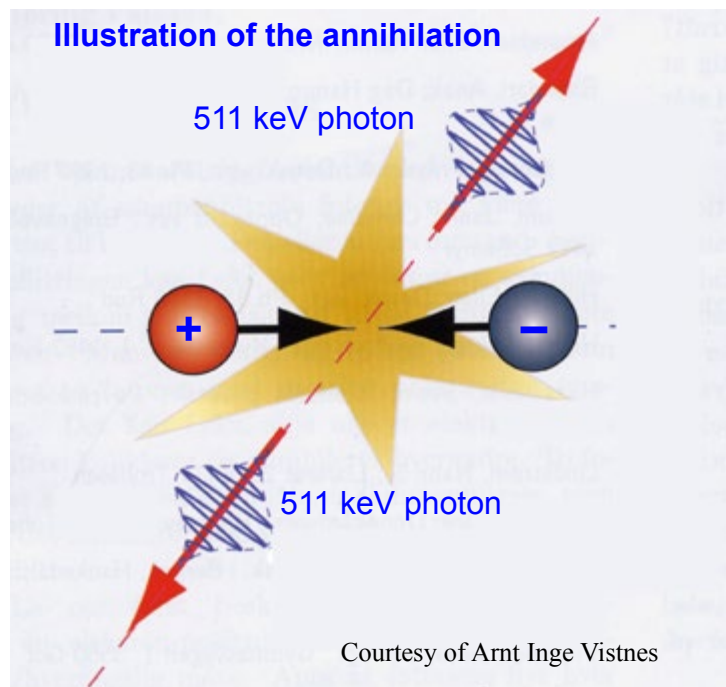

PET: We can determine the position of the radioactivity by coincidence measurements of photons with energy 511 keV. One coincidence observation yield a line whereas two or more observations in other directions give a point (or a small area) where the radioactivity has its origin. If we in addition have CT or MR measurements for body reference we can determine where in the body we find the radioactivity.

PET can give us:

1. Information on how tissue and organs functions on both the molecular and cell level.
2. PET is important to observe cancer – and in particular give information about metastases.
3. With PET it is possible to follow the effect of a treatment.
4. It is also possible to study changes in the brain that follows Alzheimer disease and epilepsy.

In PET we get information on metabolic changes on the cell level. Consequently, PET can to a larger extent observe cancer on an early level – when the changes are on the cellular level. For CT and MR malign changes can only be observed when the structure of the organs and tissue is changed.

Positron and positronium

In connection to positron emission – we have to mention the “atom” positronium.

When the positron has lost its kinetic energy and meet an electron, it is a possibility that they will exist for a short moment almost like an atom (see illustration).

It can be mentioned that the first theoretical work on positronium was carried out by Aadne Ore in 1949. Ore was connected to the group of biophysics at the University of Oslo – in fact he was the one that started this group.

Positronium can be either orto-positronium (parallel spins) or para-positronium (opposite spin). Para-positronium has a lifetime of about 0.1 nanosecond, whereas ortho-positronium has a lifetime of about 140 nanoseconds.

Para-positronium decays in two photons, both with energy 511 keV whereas orto-positronium decays in three photons (combined energy is 1.022 MeV).

Ore published the work in two articles; “Annihilation of Positrons in Gases” and “Ortho-Parapositronium conversion”.

Ore described the foundation of PET in the following way:

In Norwegian: “*Atomet er en slags submikroskopisk dobbeltstjerne, hvor de to partnere, et elektron og et positron, hvirvler om hverandre i en kortvarig dødsdans, som ender med materiell tilintetgjørelse og et bluss av elektromagnetisk stråling.*”

In English: “*The atom is a submicroscopic double star. The two partners, the electron and the positron, is in a brief dance of death, which ends with material annihilation and a flare of electromagnetic radiation*”

The flare is the origin of PET



Aadne Ore
(1916 – 1980)

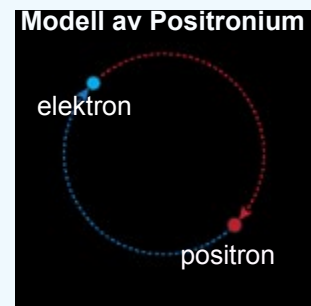
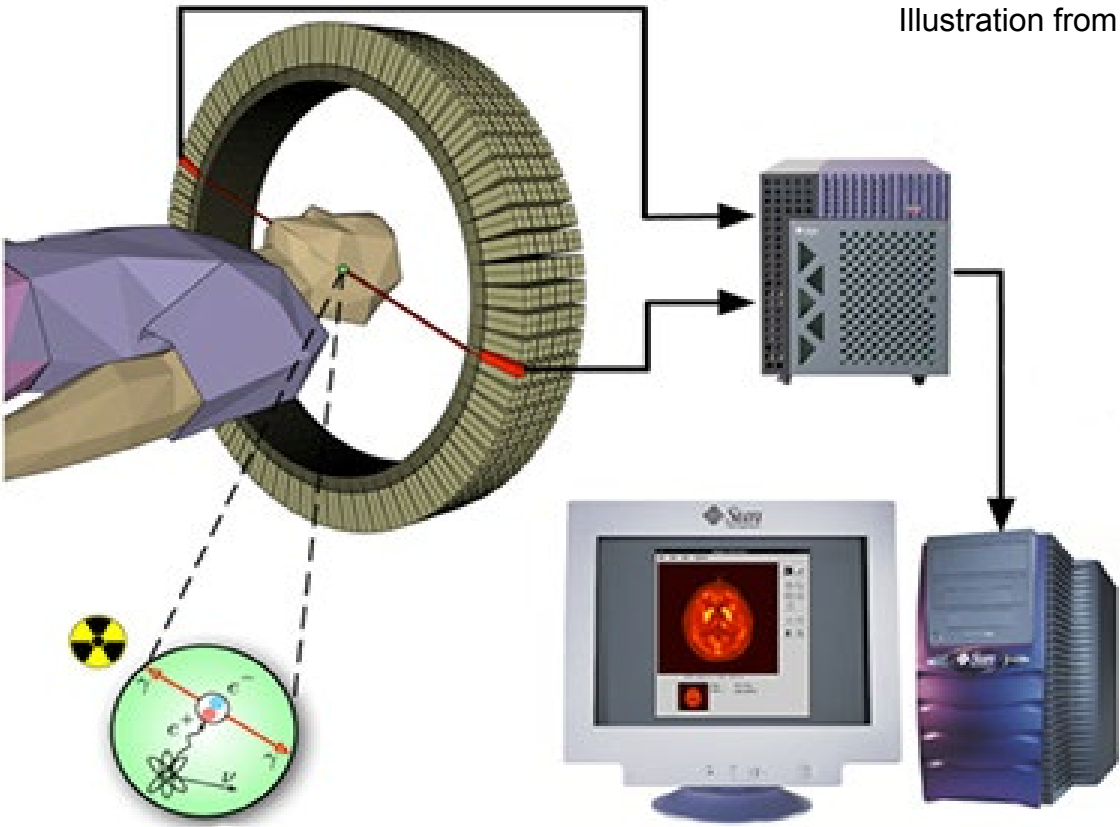

Illustration from Wikipedia



The illustration from Wikipedia give a good introduction to PET. The detectors are placed in a ring around the patient. Coincidences for two opposite detectors are measured and a picture is reconstructed. For reference within the body CT or MR is used.

Positron emitters

Only artificial isotopes are positron emitters. Som possible isotopes are given in the table:

Isotope	Halflife
C – 11	20.3 minutes
N – 13	10 minutes
O – 15	2.03 minutes
F – 18	109.8 minutes

The different isotopes have short half-lives which implies that the production and use has to take place quite close together. The isotopes must be hooked on special chemicals that can transport the positron emitter to places of interest.

C – 11 connected to acetate has been proposed as a tracer for prostate tumor cells. Also C – 11 connected to choline can be used.

F – 18 is so far the most used isotope in PET. Connected to deoxy-glucose (see illustration of the FDG-molecule) it is used to identify tumors by their increased rates of glucose metabolism compared to benign cells.

We have to mention that we also have isotopes with somewhat longer half-life. Thus, Zr-89 has a half-life of 3.27 days and I-124 has a half-life of 4.18 days.

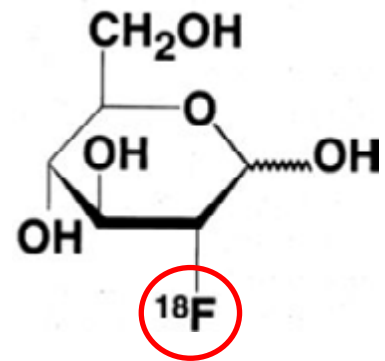

The use of F-18

F-18 can be made in a cyclotron by irradiating O-18 enriched water with protons. The reaction can be written:

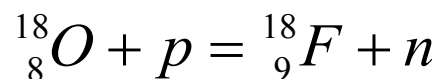

After the production of F-18 we have to work fast since the half-life is only a couple of hours. If this isotope is used for detection of cancer it is hooked on to glucose (see illustration above of the FDG-molecule). We know that the active cancer cells need more sugar than other cells in the body. Therefore, we hook on F-18 to glucose – and the sugar molecule will transport F-18 to the active cells – the cancer cells.

An example



The patient is given F-18 (as FDG) in the blood. We wait for an hour before we start the measurement to let the FDG-molecules to find the cancer cells. When F-18 disintegrates it emits a positron with maximum energy 635 keV. The positron is slowed down within about 1 mm before annihilation. Photons with energy 511 keV are measured in coincidence by detectors 180 degrees from each other. No other radiation influences these measurements. The position for this radioactivity with regard to the body is determined by CT.

In the example below we have encircled a region which in CT was suspicious. In the right picture we see the results of PET. The PET activity is colored red. The suspicious region consists of rather active cells – cancer cells.

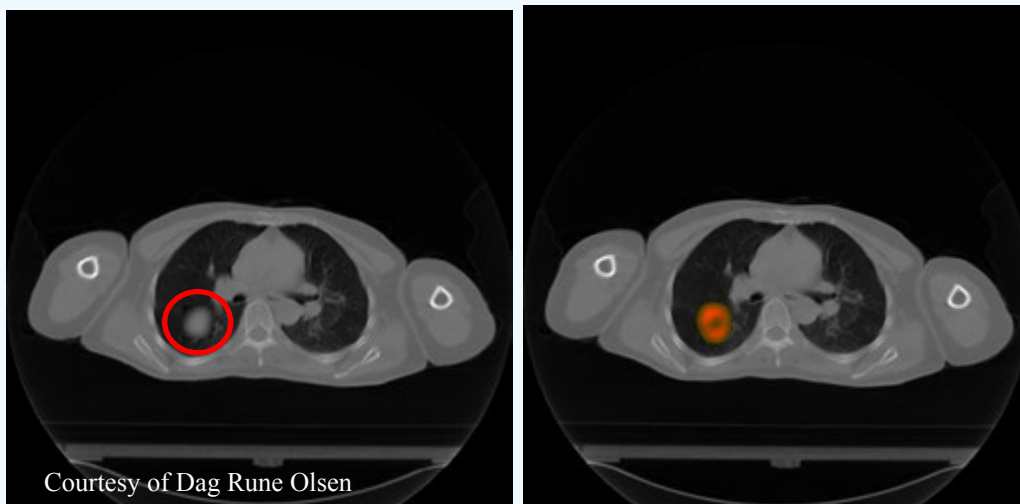

Courtesy of Dag Rune Olsen

History

The first experiments to exploit positron-electron annihilation goes back to 1953 when Gordon Brownell at MIT constructs the first detector device. The first PET experiments were performed in 1974 by Michael E. Phelps, Edward Hoffman, and Michel M. Ter-Pogossian.



Michael E. Phelps
(1939)



Edward Hoffman
(1942 – 2004)



Michel M. Ter-Pogossian
(1925 – 1996)

Alfred P. Wolf, Joanna S. Fowler and Tatsuo Ido developed F-18 fluorodeoxyglucose (FDG) – which is an important probe for glucose metabolism.

Brookhaven National Laboratory has been in the front for the development of PET. The leading scientists have been Al Wolf and Joanna Fowler.



Joanna Fowler



Alfred Wolf
(1923 – 1998)

An example: PET used to study the effect of radiation

In the example below the isotope F-18 is bound to deoxyglucose (FDG) and used to localize tumors in a patient. Two different tumors were localized; a sarcoma in the right scapula (shoulder blade) and a lymphoma in the right axillary lymph. PET with F-18 shows both cancers – and CT is used to clearly localize where they are.

The cancers were treated by radiation and the result is seen on the series of pictures – the sarcoma to the left and the lymphoma to the right.

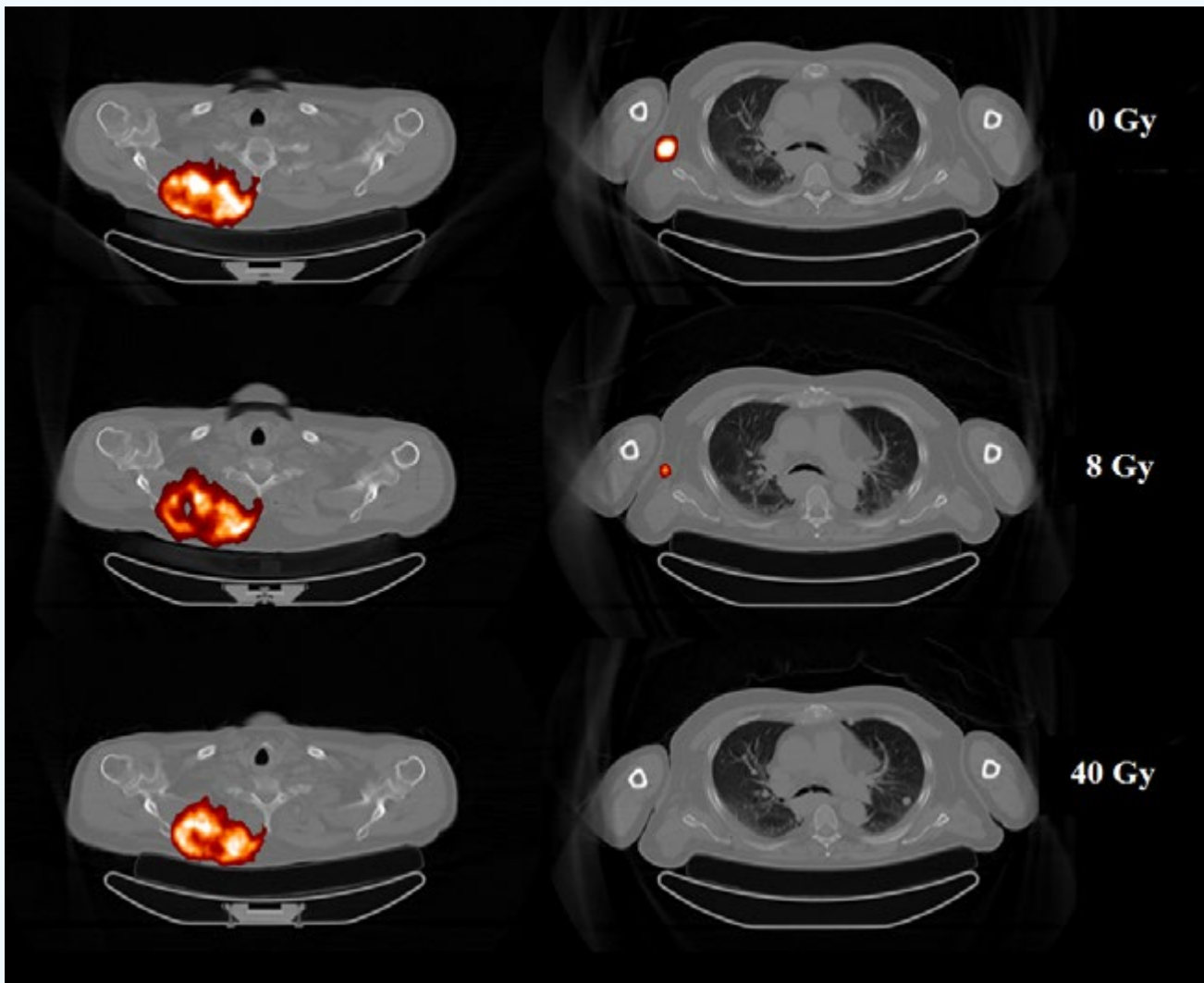

You see that the large sarcoma in the right scapula is radioresistant – independent of the radiation dose given. The lymphoma in the right axillary lymph is however radiosensitive and is eliminated after a dose of 40 Gy.

The images were taken before the start of radiotherapy (0 Gy), after 8 Gy (early treatment) and after 40 Gy (late treatment).

Courtesy of Eirik Malinen.

Magnetic resonance – MR (MRI)

Today we have other diagnostic methods in addition to, or often in combination with x-rays and radioactive isotopes. The methods in question are magnetic resonance and ultrasound. For these methods no ionizing radiation is involved and no absorbed or scattered photons are making the pictures.



What is MR ?

The very first MR-picture on a human being was made 3. July 1977 by Raymond Damadian and co-workers in USA (left). The picture obtained was of poor quality and it took hours to obtain. However, in spite of this it was a sensation and a start of a technique that today is very important within medical diagnostics.

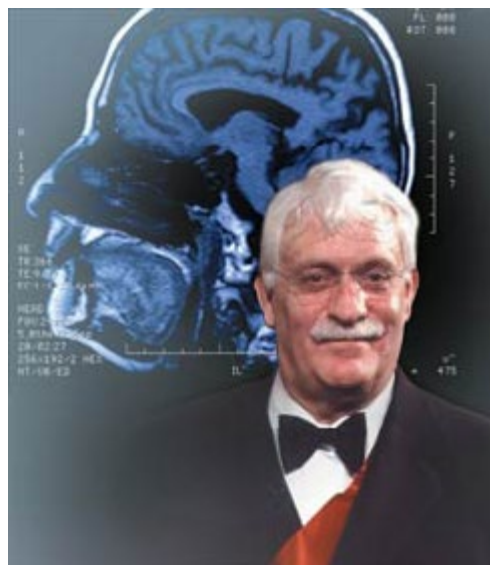

Raymond Damadian
(born 1936)
(photo from 2009)

The field of magnetic resonance started in the 1940s. In 1944 the Russian physicist Yevgeny Zavoisky discovered electron paramagnetic resonance (ESR) and in 1946 Felix Bloch and Edward M. Purcell carried out the first nuclear spin experiments (NMR).

The pioneers of magnetic resonance

Magnetic resonance was developed in the 1940s – both electron spin resonance (ESR) and nuclear magnetic resonance (NMR). The Nobel prize in physics for 1952 was awarded to Bloch and Purcell for nuclear magnetic resonance.



Yevgeny Zavoisky
(1907 – 1976)



Felix Bloch
(1905 – 1983)



Edward Mills Purcell
(1912 – 1997)

The physics of magnetic resonance

In this book we are interested in the physical background for the different medical techniques rather than to the techniques themselves. Knowledge about x-rays and radioactive nuclides was important for the methods discussed so far. In the case of magnetic resonance (both ESR and NMR) the method is based on units with a magnetic moment. In the case of ESR it implies atoms or molecules with an unpaired electron (we have mentioned ESR in connection to dosimetry on page 80 – 83).

In the case of NMR the technique is based on atomic nuclei with spin – like protons (H-1), deuterons (H-2), C-13, N-14, F-19, Na-23 and P-31. The general MR technique is based on protons in the water molecule.

Let us try to explain the background for magnetic resonance. Units with spin like the electron or proton have magnetic moments. In the case of the electron it can be written as:

$$\vec{\mu}_e = g\beta\vec{S}$$

Here β is the Bohr-magneton, S is the electron spin and “ g ” is the spectroscopic splitting factor – which for free electrons is 2,0023. A similar expression is obtained for protons. This implies that we have a number of small magnets. If these small magnets are placed in a magnetic field B , they will attain an energy which depends on the spin state. Thus, for electrons it is given as:

$$E(m_s) = g\beta m_s \cdot B$$

where m_s is the spin quantum number for the electron, which can have two values; $+1/2$ and $-1/2$. A figure would help in order to understand the resonance phenomenon.

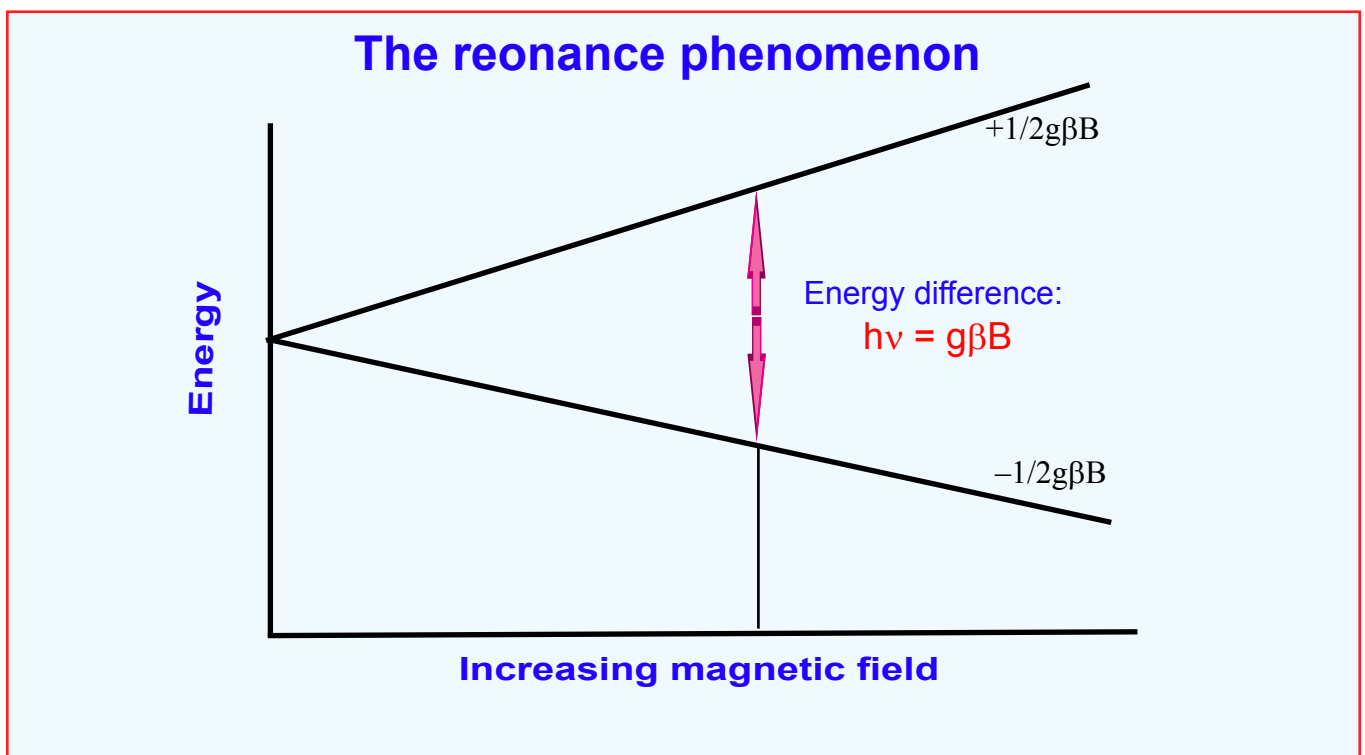

The figure show that all the small magnets have equal energy as long as the external magnetic field is zero. However, in a magnetic field the magnets will be oriented “with” or “against” the magnetic field. The two states have different energies – and the energy difference increases with the field B as shown. It is possible to induce transitions between the energy states by electromagnetic radiation. The condition for inducing transitions between the energy states is that the energy of the radiation ($h\nu$) is equal to the energy difference. A transition from the lower to the higher state yields an absorption. (A transition the other way yields an emission – i.e. the LASER condition).

The condition for an absorption can be written:

$$h\nu = g\beta B \text{ for electrons and } h\nu = g_N\beta_N B \text{ for protons}$$

The figure indicates that we can have resonance at any given frequency as long as the magnetic field follows the resonance condition. We see that the resonance condition is the same for electrons and protons. However, it is a big difference since $g\beta$ for electrons is much larger than $g_N\beta_N$ for protons. Thus, a magnetic field of 1 tesla (10 000 gauss) yield resonance for electrons at a frequency of 28 GHz (microwaves with wavelength 1 cm), whereas for protons the frequency is 42.6 MHz (in the radiofrequency region).

The electromagnetic radiation yields transitions in both directions with the same probability. Thus, if the populations of the two levels is equal, the net result would be nil – neither absorption, nor emission. The population of the states follows a Boltzman distribution with the lowest level most populated. The difference increases with increasing magnetic field. This implies that we try to increase the magnetic field and for NMR it is normal to use fields of the order 1.5 tesla (and even up to 7 tesla).

In order to have a constant absorption, the difference in population must be kept. Two relaxation processes transfer spins to the lower state. Both processes are connected to changes in the proton spin. One process is “spin-lattice” relaxation and the other is “spin-spin” relaxation. The rates of the two processes are measured by the relaxation times T_1 and T_2 .

We have seen above that the x-ray picture is a shadow of the electron density. In the case of MR the picture depends on the proton density as well as on the two relaxation times T_1 and T_2 . It appears that these relaxation times changes when going from normal to pathological tissue – and this can be used in diagnostics.

How is a picture made ?

A part of the body is placed in a strong magnetic field. The resonance condition gives the connection between field and frequency. It is therefore easy to understand that it is possible to fulfill the resonance condition for a small volume element. However, it is a long way from a volume element to a picture – and the question is: How is it possible to go from a point (a tiny volume element) to construct a whole picture?

The first solution of this came when Paul Lauturbur tried out his ideas in the early 1970s. He introduced magnetic field gradients and by analysis of the characteristics of the emitted radio waves, he was able to determine their origin. This made it possible to build up images of structures. In 1973

he demonstrated how it was possible to see the difference between tubes filled with water from an environment of heavy water. These very first experiments showed that one could use a set of simple linear gradients, oriented in three dimensions and slowly build up a picture. Peter Mansfield showed how the radio signals could be mathematically analyzed, which made it possible to develop a useful imaging technique.

One of the major practical difficulties encountered with the early MRI, was the time it took to acquire the data. Line-scanning, for example, took typically 10–20 min. The breakthrough came in 1977 when Mansfield introduced the echo-planar imaging. This snap-shot technique meant that in principle complete two-dimensional images could be achieved in extremely short times like 20 – 50 ms.

A modern MR scanner has coils in three directions (see illustration below). They modify the magnetic field at very particular points and work in conjunction with the RF pulses to produce the picture. They are rapidly turned on and off (which causes that banging noise), and the gradient magnets allow the scanner to image the body in slices. The transverse (or axial, or x-y) planes slice you from top to bottom; the coronal (x-z) plane slice you lengthwise from front to back; and the sagittal (y-z) planes slice you lengthwise from side to side. However, the x, y and z gradients can be used in combination to generate image slices that are in any direction, which is one of the great strengths of MR as a diagnostic tool.

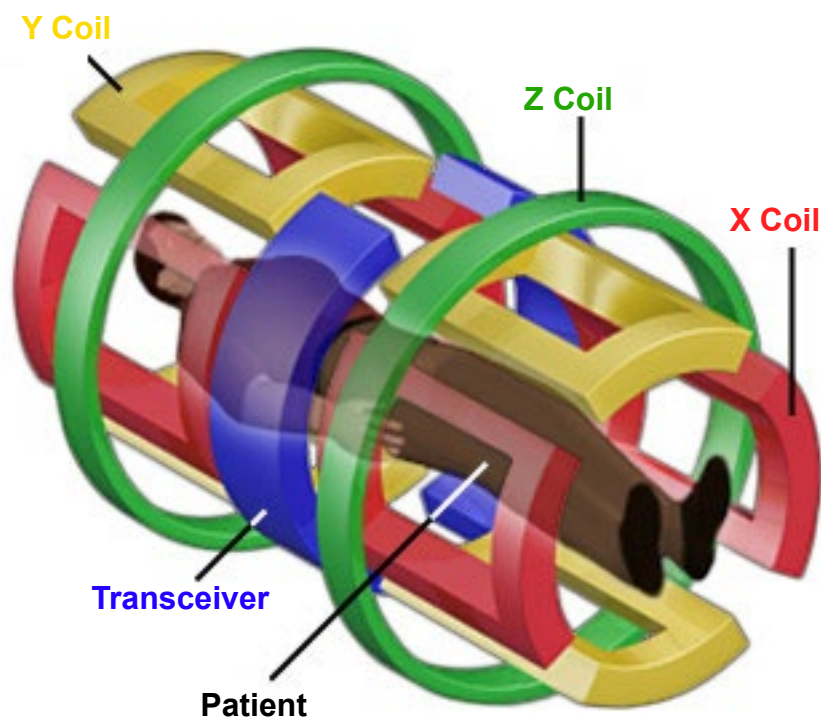

An illustration of the field gradient coils. They usually give off a banging noise.

(Illustration taken from Internet)

Nobel prize for MR – 2003

The Nobel prize in Physiology or Medicine for 2003 was given to the field of MR. The winners were Paul Lauterbur and Peter Mansfield for their contribution.



Paul Christian Lauterbur
(1929 – 2007)



Sir Peter Mansfield
(b. 1933)

Lauterbur introduced magnetic field gradients, which made it possible to obtain a picture. Mansfield showed how the radio signals can be mathematically analyzed, and thus made the image possible. He also discovered how fast imaging could be possible by developing the MR protocol called echo-planar imaging. Echo-planar imaging allows T_2 weighted images to be collected many times faster than previously possible. It also has made functional magnetic resonance imaging (fMRI) feasible.

In connection with this Nobel prize it is quite easy to understand that Raymond Damadian who obtained the very first MR-picture was disappointed and expressed this in several newspapers. Damadian and coworkers also discovered in 1971 that some malignant tissue, obtained from implanted tumors removed from rats, had longer NMR relaxation times than many normal tissues.

The technique has been further developed in several ways. In 1991 Richard Ernst was awarded the Nobel prize in chemistry for the introduction of Fourier transform and pulse techniques in NMR spectroscopy, thereby improving the sensitivity of the technique tenfold or even hundredfold. Furthermore, functional MR have been available for some years.

In order to attain better resolution MR machines with larger magnetic field have been available. There are different MR machines that use field strengths of 3 and 4 tesla, – and research machines with 9.4 tesla and even 15 tesla.



Richard R Ernst
(b 1933)

MR pictures and use in medicine

Most MR scanners in the hospitals are using 1.5 tesla magnets. The electromagnets consist of a solenoid cooled down to about 4 K by liquid helium. At such temperatures superconduction is attained and it is possible to send large currents through the solenoid and thus get the large magnetic fields required.

MR can be used to study all different organs in the body. For parts of the body with bones it is difficult to use x-rays to study the tissue around – because the bones absorb the x-rays much more than the tissue. In these cases MR is very valuable. It has been used to study details in the brain and spine. Brain sickness results in changes in the water content which can be visualized in MR. Thus, only a difference in water content of 1 percent can be detected. Multiple Sclerosis (MS) can be studied and followed by MR. The sickness give infections to brain and spine and with MR it is possible to localize this, and observe the effect of a treatment.

Contrast compounds

It is also possible to introduce contrast media in MR. We can mention the element gadolinium (Gd). This is a Lanthanide element (atomic number 64) that is paramagnetic and has the effect that it strongly decrease the T1 relaxation times of the tissues.

Also several vanadyl compounds are used as contrast agents for MR. These compounds are taken up by, and accumulate in, glycolytically active cells, such as rapidly dividing tumor cells. The resulting MR images have excellent resolution and contrast. These compounds also bind to albumin in the blood, allowing for the assessment of blood volume at tumor sites prior to cellular uptake (similar to imaging with gadolinium), a valuable diagnostic indicator and tool for treatment response in its surroundings.

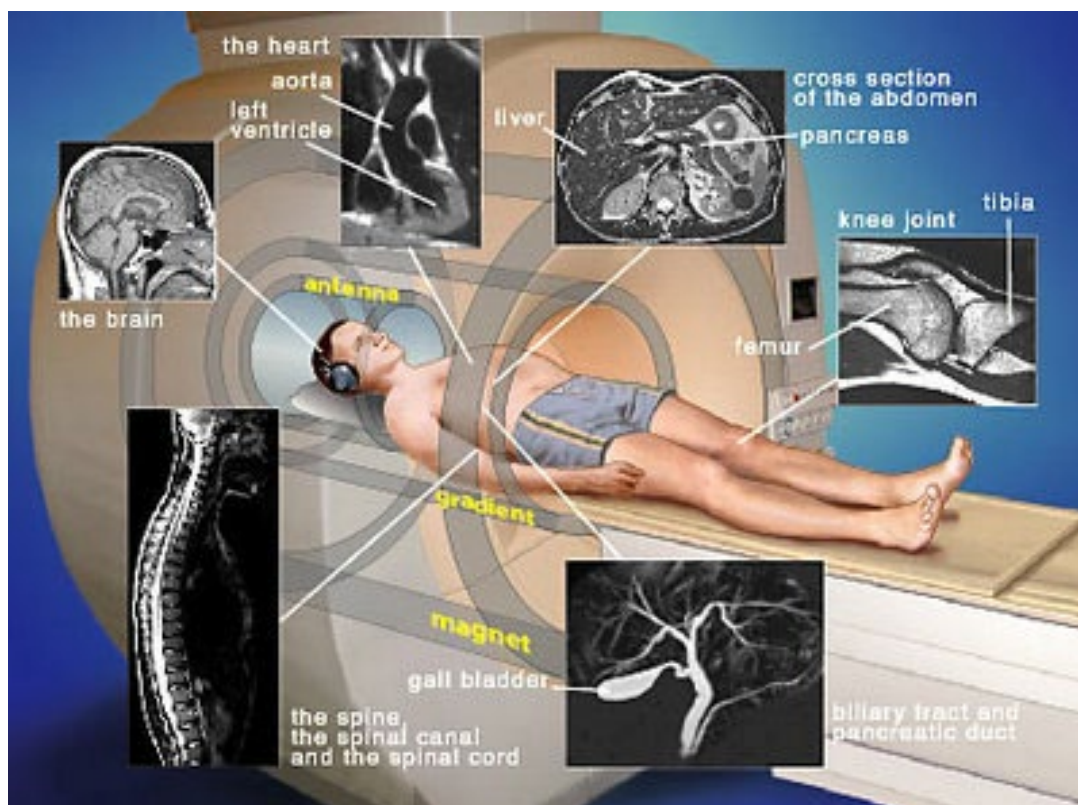

Diagnostic ultrasound

Ultrasound is sound waves with a frequency above the limit for human hearing – about 20 kHz. For medical use the frequency is in the region from 2 – 40 MHz.

Formation of ultrasound

In 1880 Pierre Curie and his brother Jacques discovered that certain crystals (the so-called piezoelectric crystals) can produce a pulse of mechanical energy (sound pulse) by electrically exciting the crystal. Furthermore, the crystals can produce a pulse of electrical energy by mechanically exciting the crystal. This ultrasound physics principle is called the piezoelectric effect (pressure electricity). Crystalline materials with piezoelectric properties are quartz crystals, piezoelectric ceramics such as barium titanate or lead zirconate titanate.

A device that converts one form of energy into another is called a “*transducer*” – and they can be used for production and detection of diagnostic ultrasound.

We are not going into more details about the equipment here, but it is possible to use ultrasound technique to produce pictures of the inside of the body. Since ultrasound images are captured in real-time, they can show the structure and movement of the body’s internal organs, as well as blood flowing through the blood vessels. Ultrasound imaging is a noninvasive medical test that helps physicians diagnose and treat medical conditions.

A short history

The origin of the technology goes back to the Curies, who first discovered the piezoelectric effect. Attempts to use ultrasound for medical purposes started in the 1940s when they used a continuous ultrasonic emitter to obtain images from a patient’s brain. During the war it was a rapid development within ultrasound. They generated pulsed echoes and developed Sonar and Radar. A spin-off from Sonar is ultrasound medical imaging.

The use of Ultrasonics in the field of medicine had nonetheless started initially with its applications in therapy rather than diagnosis, utilising its heating and disruptive effects on animal tissues.

An excellent review of the history of ultrasound can be found in the following address:

<http://www.ob-ultrasound.net/history1.html>

A short description of the technique

In the clinical use of ultrasound a transmitter produces a short pulse of electrical oscillations (2 – 10 MHz). The transducer converts this to a pulse of mechanical vibrations. The transducer is coupled to the body by a gel and the pulse of ultrasound goes into the soft tissue (speed of about 1500 m per second). The transducer will then sense the reflected, weaker pulses of ultrasound and transform them back into electrical signals. These echoes from different organs are amplified and processed by the receiver and sent to the computer, which keeps track of the return times and amplitudes.

A new pulse is produced and sent off in a slightly different direction (pulse repetition frequency is in the range 2 – 10 kHz). The data from all these pulses are treated by the computer and yield a CT-like image in “real time”. You can see how arms and legs of a fetus move, or see the heart valve open and close.

A lot of technology is involved in the different parts of the ultrasound technique. However, it is not the purpose of this book to go into details in this field.

Let us shortly mention that the transducer, that transmits and receives the ultrasound energy into and from the body is a key component. It is built up of hundreds of transducers in order to take a high resolution real-time scan. The many transducers create a wavefront and the angle of the wavefront can be altered by firing the transducers one after another. By changing the angle of the wavefront, a three-dimensional image can be built up over a large area.

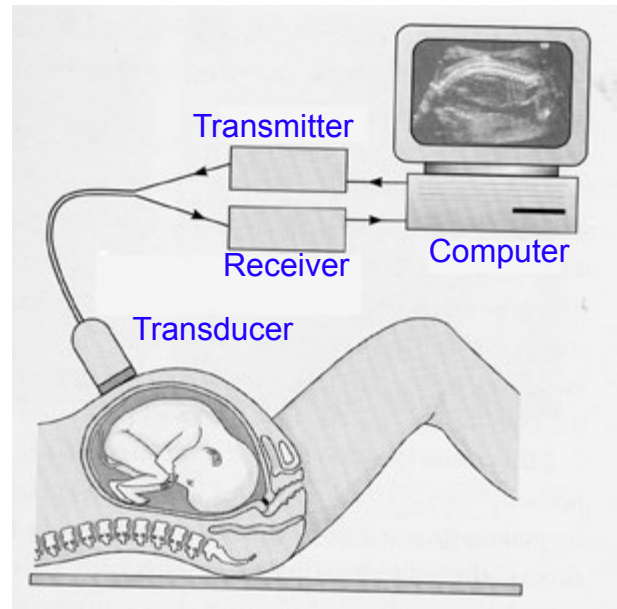

The main components of ultrasound

Doppler ultrasound

The velocity of the blood can be measured by the Doppler effect – i.e. the change in ultrasound frequency. If the ultrasound frequency is 5 MHz and the blood velocity is 20 cms⁻¹, the change in frequency is 1274 Hz if we look along the bloodvessel (the frequency shift changes with cosϕ to the viewing angle) – and can easily be measured.

Side effects

Current evidence indicates that diagnostic ultrasound is safe even when used to visualize the embryo or fetus. In this connection we would like to mention that research in the beginning of 1980s showed that use of clinical ultrasound equipment could result in water radicals (H. and OH.). Furthermore, in work with cells in culture exposed to ultrasound resulted in damage (similar to those known from ionizing radiation).

This implies that if you believe in the LNT-hypothesis where even the smallest radiation dose is deleterius we have a problem and a possible side effect.

May be we should not overdue obstetric ultrasound.



Radiation doses in medicine

Each time you are examined by radiation you attain a small radiation dose. The doses from medical use add to the background dose.

In the figure to the right is given the world average use of radiation for medical imaging. It has been a rapid increase since the 1940s. New techniques and methods have been added with the result that the total dose (the collective dose) has increased.

Since the 1950s it has been a goal to keep the doses for each examination as low as possible – in order to prevent any deleterious effects of radiation.

It may be of interest to attain some information about the radiation exposure from diagnostic medical examinations. For this purpose UNSCEAR have collected a lot of information from all different sources around the world. The Committee concluded that medical applications are the largest man-made source of radiation exposure for the world's population. The doses are in general small and are justified by the benefits of accurate diagnosis of possible disease conditions.

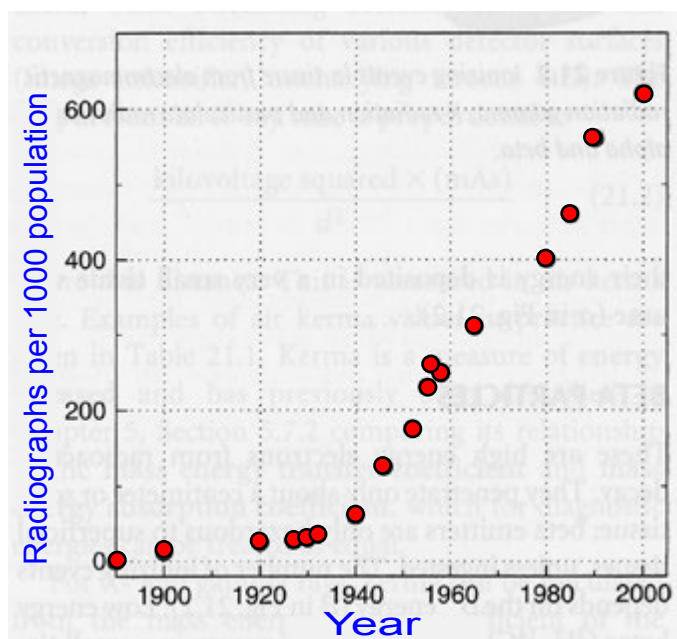

The figure shows the use of x-rays for imaging since the start in 1895



The 2000 UNSCEAR report conclude that the world average effective annual dose per capita from medical use is 0.4 mGy (or mSv). The variation from one country to another is large, approximately from 0.05 to 1.3 mGy.

For Norway the annual dose level is now assumed to be 1.1 mGy.

How to observe annual doses ?

The dose given in each type of examination has been observed and calculated. Thus, the absorbed dose to each organ or tissue of the body have been obtained. This implies that the effective doses to patients undergoing different types of medical diagnostic have been obtained. Multiplied with the number of examinations yield an effective collective dose in the LNT terminology. From this per capita annual doses can be obtained by averaging the collective doses over the entire population (including non-exposed individuals).

This procedure yield a world average of 0.4 mSv and for countries like Norway an annual dose per capita of 1.1 mSv.

Will this dose give deleterious effects ?

There is no direct evidence that diagnostic use of radiation ever causing any harm to the public. It is evident that the dose to certain groups of patients may be relatively large, for example for a number of patients with tuberculosis where chest fluoroscopy was used through 2 – 5 years. Significant doses has also been the result after the use of thorotrast in the period 1930 – 1950.

However, the collective dose to the public (1.1 mSv to Norwegians) is only a figure that shows the standard of health care and can not be used to calculate deleterious effects. Some people like the most devoted supporter of the LNT-hypothesis would disagree with this view. According to this hypothesis it is possible to claim that about 250 fatal cancers per year would be the result for Norway with a population of 4.7 million. Do not believe it!

We mentioned two exceptions from the genral positive picture. The old use of Thorotrast and the use of fluoroscopy in combination the the pneumatorax treatment for tuberculosis. Let us explore this in some more detail.

Thorotrast

Thorotrast was widely used from 1930 – 1950. It is in the form of thorium dioxide colloid. Thorotrast is retained by the reticuloendothelial system, with a biological half-life of several hundred years, so that such patients suffer lifetime exposure to internal radiation. Some of the decay products, principally the radium isotopes Ra-228 and Ra-224, escape from the colloidal particles and deposit in the skeleton.

The doses involving α -particles may be rather large. The biological end-points include liver cancer and leukemia and it can be concluded that Thorotrast increased the carcinogenic risk.

Tuberculosis and chest fluoroscopy

In the period 1930 – 1960 a large number of patients with tuberculosis were treated by pneumathorax – air was filled in the cavity of the chest and the lung was forced to collapse. The aim of the treatment was to give the lung an opportunity to rest.

In order to control the air filling the patient was x-rayed both before and after the filling and fluoroscopy was the method. A treatment could last for a number of years and consequently the number of x-ray examinations could be up to 100 and more. This resulted in a rather large dose to the breasts.

A number of TB-patients have been followed up in order to observe deleterious effects such as breast cancer for women. The results are not easy to understand – see next page.

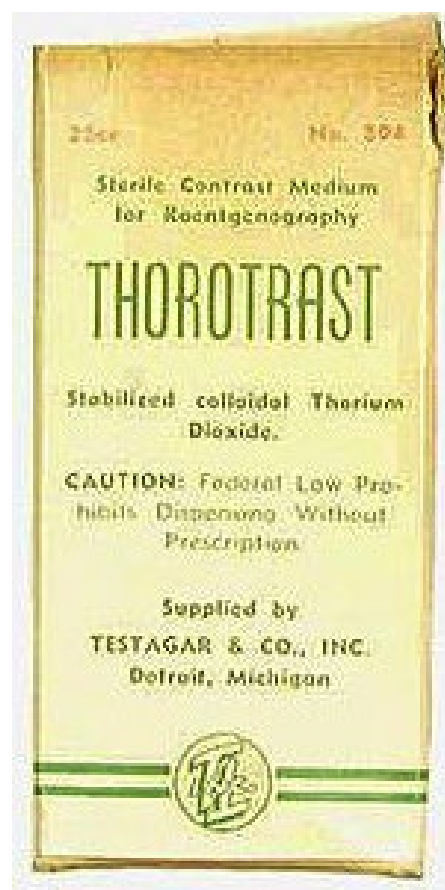

A Canadian study looked at breast cancer mortality rates for women who had fluoroscopic examinations for tuberculosis, between 1932 and 1952. The results are given in the figure below.

We have several comments with regard to this figure. **First of all the dose determination is highly uncertain** – can probably vary by a factor 2. Second, no information exist about the doses received in the time elapsed since the last examination – i.e. background variation.

Despite of these weak points, the data show a surprising decrease in cancer for those who received low doses (34 percent and 16 percent at the dose points of about 15 and 25 centi-Gray).

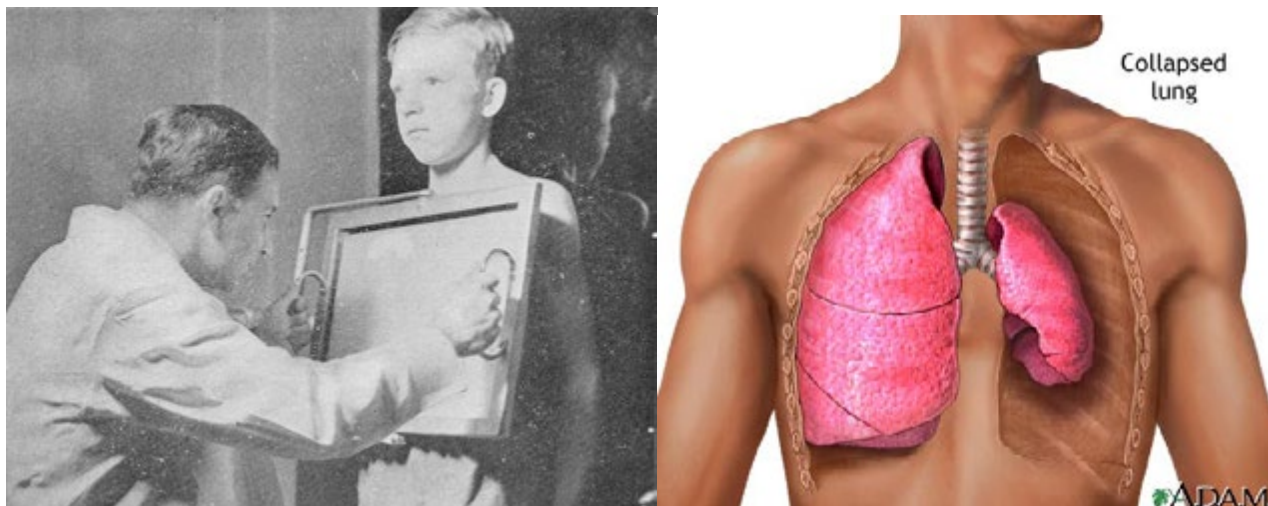

The picture shows a typical examination from about 1940. The lungs are examined both before and after air is filled. This is done in order to control the collapse of the lung – as shown in the illustration.

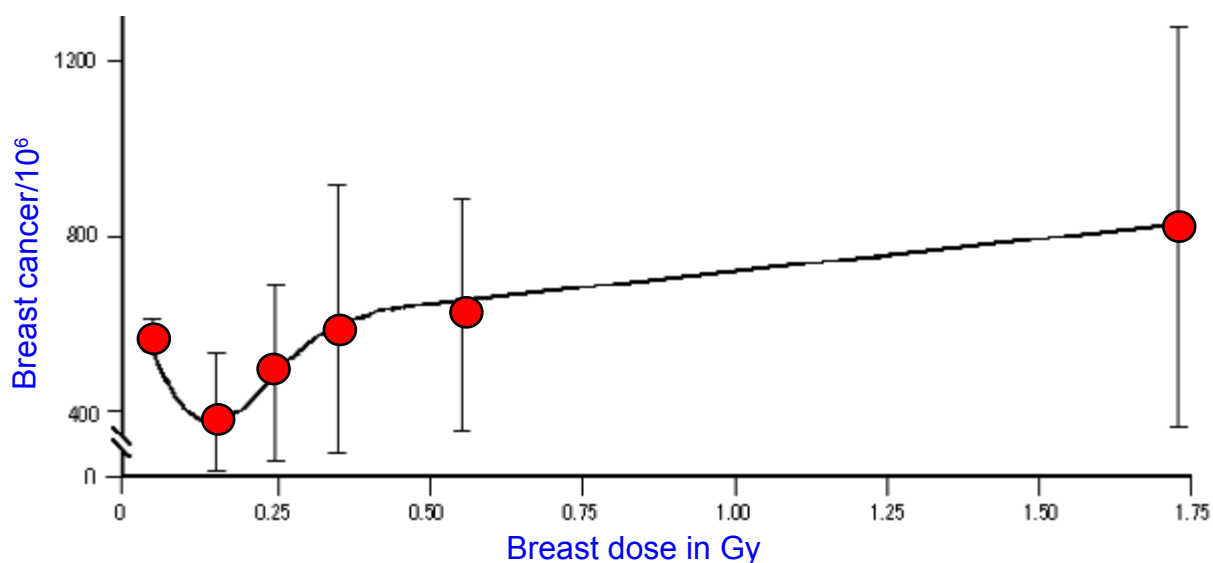



Chapter 10

Radiation used for therapy – radiation therapy

In this chapter we shall discuss the use of radiation for cancer therapy. For this purpose the radiation source is usually outside the body – and a number of large therapy sources have been developed. Furthermore, radium and other radioactive isotopes have been used both in the form of external sources as well as sources placed inside the body.

Let us however, start with the three strategies available for fighting cancer, namely;

1. Surgery
2. Radiation
3. Chemotherapy

Surgery is by far the strategy with the best long-lasting results, but radiation seems to be a good number two. Radiation may be used as the prime treatment of the cancer as well as in connection with other treatment strategies like surgery. Radiation is often used for palliative treatment – that is to release pain and improve the quality of life for the cancer patient..

It is interesting to see the improvements of radiation therapy from the first fumbling experiments more than 100 years ago. The improvements are mainly based on the developments of radiation sources as well as the diagnostic improvements that gives us the opportunity to give large doses to the tumor with a smaller damage to the surrounding healthy tissue.

The early history

Shortly after the discovery of X-rays and radioactivity in 1895 and 1896, some deleterious biological effects like hair loss and skin damage were observed. This resulted in the idea that the radiation may be used to treat superficial skin diseases and unwanted hair. The first fumbling experiments in radiation therapy started with simple instruments (sources) and with no dosimetry system developed. Let us briefly mention some of the highlights from that period.

1896 Emil Grubbe

A young medical student in Chicago, named Emil Grubbe, obtained in 1896 an x-ray tube. He observed that the radiation resulted in skin reddening (like sunburn). As a consequence of this he convinced one of his professors to allow him to irradiate a cancer patient suffering from locally advanced breast cancer. The patient benefited from this treatment, demonstrating the potential value of radiation for therapy. By doing so, Grubbe became the world's first radiation oncologist



Emil Grubbe
(1875 – 1960)

1899 Cancer is successfully treated in Sweden

The first proven successful x-ray treatment of histologically verified cancer was reported at the Swedish Society of Medicine meeting in December 1899 by Thor Stenbeck and Tage Sjögren.

The Stenbeck case was a basal cell carcinoma of the nose, and the Sjögren case was a squamous cell carcinoma of the cheek; both cases were documented by photographs. It can be mentioned that the patient with treatment of the nose was healthy 30 years later.

In Sweden Tage Sjögren opened the first private x-ray institute already in 1899. In 1910 Radiumhemmet in Stockholm was opened. They started the treatment based on 120 mg Ra – i.e. $4.44 \cdot 10^9$ Bq.

One of the Swedish pioneers was Gösta Forssell.



Gösta Forssell
(1876 – 1950)

1901 – 1904 Radium was introduced as the radiation source

The first clinical use of radium was reported by Henri Danlos in 1901, who successfully treated a few cases of lupus with a mixture of radium and barium chloride. Also other investigators explored the use of radium in chronic inflammatory skin diseases.

When radium is used the treatment is based on the γ -radiation. Radium has during the years been used both for “*teletherapy*” as well as for “*brachytherapy*”.

The picture shows an example of teletherapy from about 1930. The source is 2 gram and the distance to the skin about 3 cm.

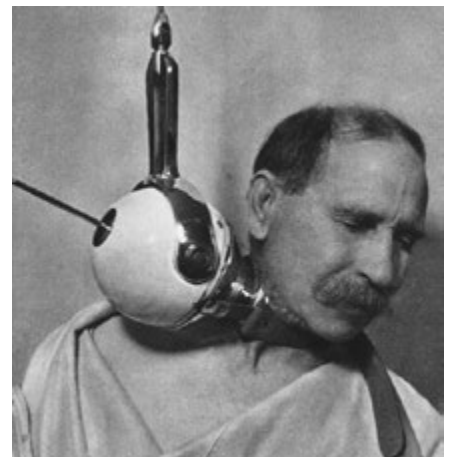

Radium teletherapy

It all started in the 1920s with radium in a lead container and with an opening to let out the radiation. The γ -radiation from radium and its decay products consists of 49 γ -lines with energies ranging from 0.184 to 2.45 MeV. The average energy is 0.83 MeV. This is much higher than the x-ray sources available at that time (up to about 200 kV with maximum energy of 200 keV). Consequently, the radiation from radium was more suited for tumors below the skin (we shall discuss depth-dose curves later on).

We also have to mention the disadvantage of using radium and other radioactive sources. The radiation **can not be stopped** – and this consequently implies problems with regard to storage. Furthermore, the personnel treating the patients will be exposed more or less when positioning the patients.



Radium sources and dosimetry

The sources consisted of about 1 to 5 gram of the isotope Ra - 226. This implies that the strength of the source, measured in becquerel, is in the range; 30 – 200 GBq (1 Gbq = 10^9 Bq)

Comments on dosimetry

A radium source of 1 gram yield a dose of $8.4 \cdot 10^{-3}$ Gy per hour at a distance of 1 meter. Consequently, if we take the distance into consideration (inverse square law) and use a source – skin distance of 3 cm the skin dose would be:

$$D = 8.4 \cdot 10^{-3} \cdot (100/3)^2 \text{ Gyh}^{-1} = 0.16 \text{ Gy per minute}$$

Today we usually give a treatment in fractions of 2 Gy per day. This would imply a treatment time of approximately 10 minutes and upwards with the old teletherapy machines. The source skin distance is the most important parameter.

We must point out that in those years none or very simple dosimetry systems were available (see chapter 5 and in particular page 58).

Teletherapy in Norway

On page 55 (also to the right) you can see a picture of the teletherapy unit that was used at The Norwegian Radium Hospital from about 1932. The source consisted of 3 gram radium; that is 3 Ci or 111 GBq. The source skin distance was about 10 cm. Using the above information, it is easy to calculate that the dose per minute was 0.042 Gy.

The treatment time for a dose of 2 Gy would be 47 minutes.



Radium brachytherapy

Brachytherapy (“brachios” is a Greek word, meaning “short-distance”) is a form of radiotherapy where the source is placed on the skin or inside the body. It is often used for treatment of cervical, prostate, breast and skin cancer.

The first successful brachytherapy application for malignancy was carried out at St. Petersburg in 1903 for basal cell carcinoma of the facial skin.

About 1904 the intercavitary use started for uterine and cervical cancers. This opened a broad field of applications in brachytherapy. In the next few decades it was a continuous refinements in applicator design and dosimetry methods.

In 1903, Alexander Graham Bell wrote;

“There is no reason why a tiny fragment of radium sealed in a fine glass tube should not be inserted into the very heart of the cancer, thus acting directly upon the disease material. Would it not be worthwhile making experiments along this line ?

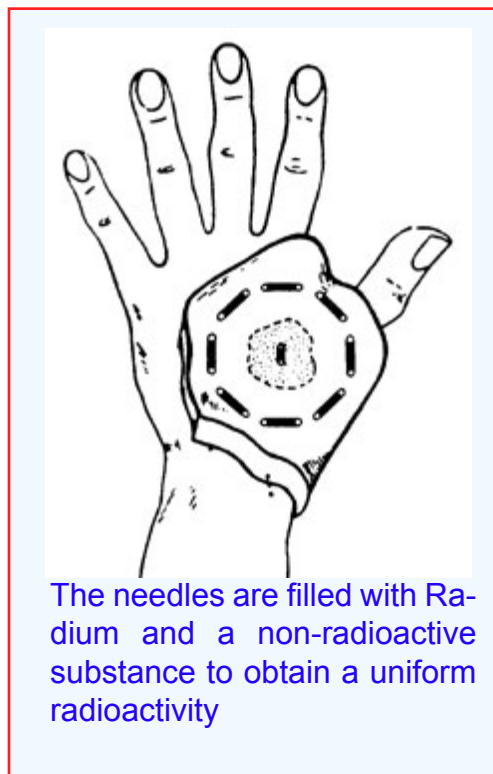

The needles were about 1 cm long and 1 mm in diameter and contained radium in the form of radium sulfate or radium chloride. The content of radium in the needles was a few milligram (see page 54). One of the problems with the radium needles was leakage of the decay product radon, which is a noble gas.

Fractionation therapy

Claude Regaud at the Radium Institute in Paris recognized in the 1920s that treatment may be better tolerated and more effective if delivered more slowly with modest doses per day over several weeks.

This approach, known as *fractionation*, is one of the most important underlying principles in radiation therapy.

Today, fractionation lies at the heart of many treatment programs currently used in radiation oncology. The total dose is fractionated (spread out over time) for several important reasons:

1. Fractionation allows normal cells time to recover, while tumor cells are generally less efficient in repair between fractions.
2. Fractionation allows tumor cells that were in a relatively resistant phase of the cell cycle during one treatment to cycle into a sensitive phase before the next fraction is given.
3. Tumor cells that were chronically or acutely hypoxic (and therefore more radioresistant) may re-oxygenate between fractions. This would improve the tumor cell kill.



Claude Regaud
(1870 – 1941)

The fractionation regimes are quite equal around the world – and the typical fractionation schedule for adults is about 2 Gy per day, five days a week.

1950s and high energy radiation therapy machines

With the ordinary x-ray equipment the upper limit in energy was about 250 kV. With the Ra-sources the energy was up to about 1 MeV. However, in order to treat tumors inside the body, without too much burning of the skin, it was important to attain radiation with higher energy. This high energy radiation equipment came into use in the 1950s with the first betatrons and in 1960s with linear accelerators.

In order to understand the advantages with high energy photons let us explore the depth dose curves. We discussed this slightly on page 77 and showed examples of depth dose curves for soft tissue.

Depth dose curves

X- and γ -radiation is absorbed by the three processes; photoelectric effect, Compton-scattering and pair production. In all these processes secondary electrons are formed – that, in turn, give off energy in ionization and excitation processes when they are slowed down and stopped.

The radiation dose is defined as energy absorbed. Both the primary ionizations, as well as the energy given off by the secondary electrons, contribute.

The number of secondary electrons *increases* from the surface of the skin and down to the range of the most energetic secondary electrons for the radiation in question. Thus the range of electrons with a start energy of 1 MeV is approximately 0.5 cm in tissue. Electrons with a start energy of 10 MeV will have a range of about 5 cm.

As a result of this – we observe a region under the skin where the energy absorption, or rather the dose, increases and reach a maximum before it starts to go down. This is the so-called “*build up region*”

For ordinary X-rays (up to 250 kV) the build-up region is less than one mm. For the radiation from Ra and Co-60 it is about 5 mm.

In order to give maximum doses to tumors inside the body the therapist would like to have radiation with higher energy and thus be able to extend the “build up region” to 3 – 10 cm inside the skin. Such a requirement calls for high energy radiation accelerators.

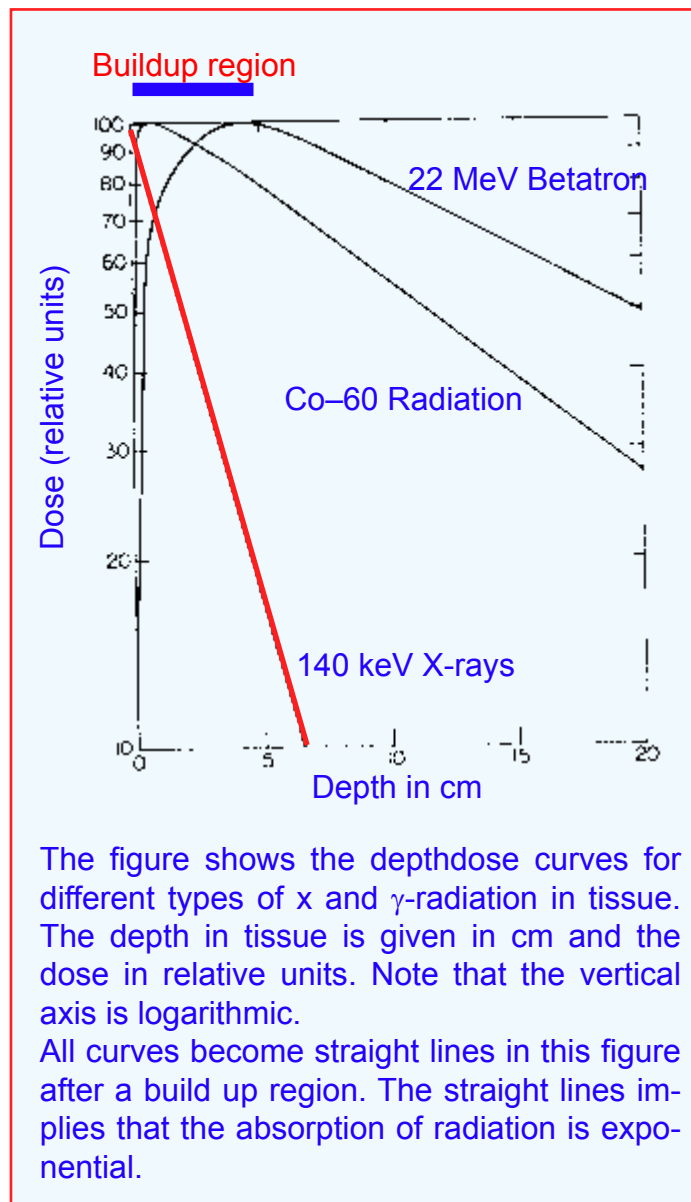

High energy accelerators – Betatrons and Linear accelerators

The first high energy therapy units were betatrons and linear accelerators. For both types electrons are accelerated to an energy of from about 10 MeV to 35 MeV. When the electrons reach the maximum energy they smash into a metal target and “*bremstrahlung*” with maximum energy like the maximum electron energy is formed. The radiation spectrum is equal to that for x-rays – but includes much higher energies. In the pictures on page 77 and on the page above you can see the resulting depthdose curve for radiation from a 22 MeV betatron.

Let us see in some more details into the physics behind the betatrons and linear accelerators.

Betatron

The first ideas with regard to particle accelerators was put forward in the 1920ties by the young Norwegian Rolf Widerøe. He came to Germany as a teenager and started his studies. Already in 1923 he proposed the principle for the betatron. He called it the “Strahlentransformator”. However, he was not able at that time to construct the accelerator itself.

The first workable betatron was made in 1940 by Donald Kerst in USA. In April 1941 he submitted his famous paper on the operation of the 2.3 MeV-betatron to Physical Review.

In a betatron electrons are accelerated in a toroidal vacuum chamber (a doughnut) by a magnetic field. The electrons are kept within the torus by the magnetic field (see illustration).

The relation between the accelerating field and the field that keep the electron in place is given by the “*betatron condition*” (also called the *Widerøe-relation* for betatrons):

$$B_1 = 1/2 B_2$$

i.e. the steering field is half the acceleration field.

The first betatron for radiation therapy was the 15-MeV Hamburg-betatron in 1944.

In 1946 Rolf Widerøe started to work on a 31 MeV-betatron for the Swiss company BBC (Brown Boveri and Cie). The betatron was designed for radiation therapy and the first one was installed at the Kanton hospital Zurich and used for the first patient in April 1951.

The next BBC betatron was delivered in the summer of 1952 to the Norwegian Radium hospital.



Donald William Kerst
(1911 – 1993)

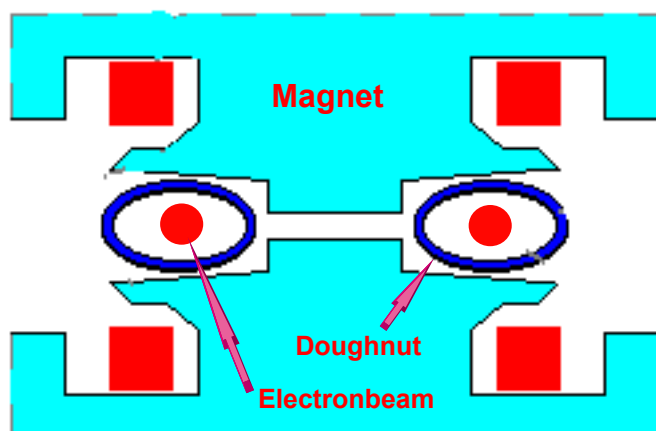

An illustration of the main parts of a betatron. Electrons are accelerated and kept in a torus (blue) by a magnetic field.

Linear accelerator

The use of betatrons for radiation therapy lasted some years – before the cheaper and simpler linear accelerators took over. Again Rolf Widerøe played a significant role in the development of the linear accelerators. It started already in 1927 when Widerøe built a small linear accelerator where he could accelerate potassium ions to 50,000 volts, having only 25,000 volts at his disposal. In the figure below we have shown the experimental setup. The ions pass successively through three drift tubes: the first and last are grounded, the center one is attached to a 1 MHz oscillator with a voltage of 25 kV. The distance d between gaps is adjusted so that it is:

$$d = \frac{\beta\lambda_0}{2} \quad \beta = v/c \text{ and } \lambda_0 = \text{free space wavelength}$$

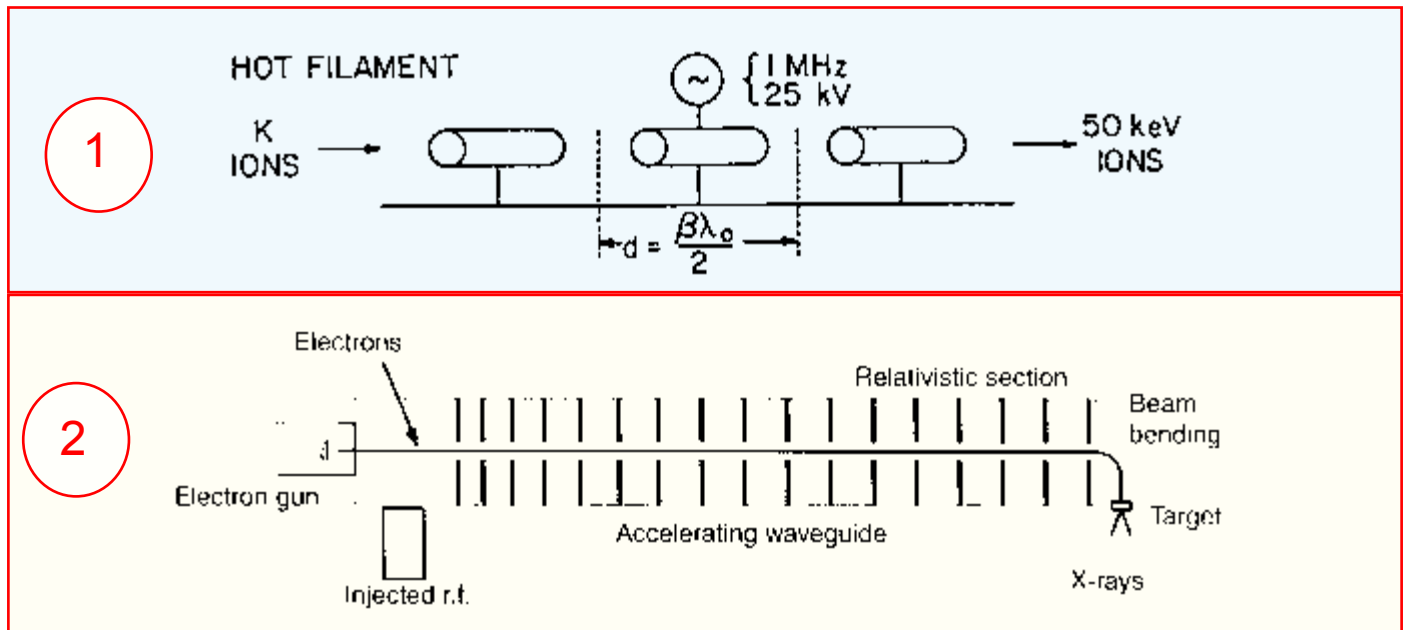

Figures that give the principle for the linear accelerator. Above is the simple Widerøe's linear accelerator. The potassium ions travelled from one gap to the next in $1/2$ radiofrequency period. The ions attained an energy of 50 keV.

In the lower figure electrons are accelerated by interacting with a synchronised RF-field. The accelerating waveguide is a long cylindrical tube with a series of cylindrical baffles. Electrons are generated in bunches in the gun and these electrons are riding or surfing on the microwave radiation to an energy of 6 MeV or above. They can be used directly or they may hit a high atomic number target and the kinetic energy is converted to heat and X-rays (bremsstrahlung).

In the illustration to the right you can see the interior of a linear accelerator. You see the acceleration tube where the electrons reach the high energy. When the electrons hit the target a part of the energy is converted to x-rays. This beam is colored yellow.



Henry Kaplan was the first one to use a linear accelerator at Stanford Hospital in San Francisco in 1957. The patient was a boy (Gordon Isaacs) that was suffering from a tumor in his eye (retinoblastoma). The treatment saved the child's sight and he lived the rest of his life with his vision intact.

Below is a picture taken during the treatment.

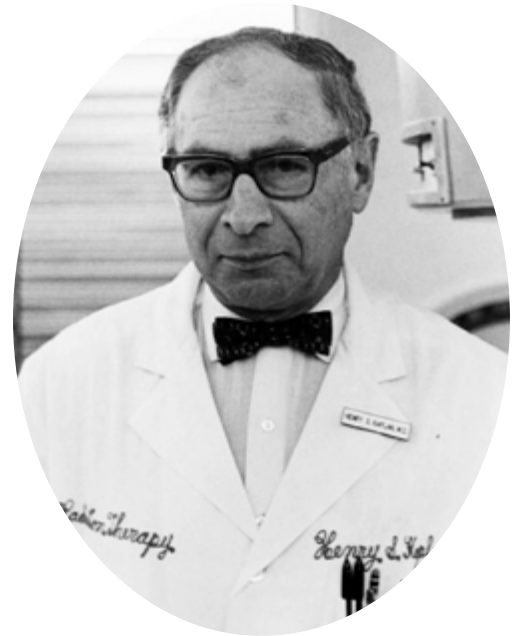

Henry Kaplan
(1918 – 1984)

Fifty years and about 50 million patients later, medical linear accelerators have become the backbone of radiation therapy for cancer worldwide. Roughly half of all cancer patients receive radiation therapy, primarily from the rays generated by a linear accelerator.

Guidelines for treatment

The goal for radiation treatment is to kill the cancer cells. This can be achieved by giving a dose of radiation that is large enough for killing. However, you will always irradiate healthy tissue near the tumor. You are faced with a situation where you should kill the cancer cells and at the same time give the healthy tissue the smallest available radiation dose. This is a “*balance on a knives edge*” situation.

The advancement in radiation therapy is due to the use of higher energy of the x-rays which has given more suitable depth-dose curves (see page 219). In recent years ions with high energy have been introduced. They all have depth-dose curve which ends with a Bragg-peak (see pages 29 and 77). The goal is to position the Bragg-peak in the center of the tumor – and thus optimize the radiation.

The improvements in radiation quality have been followed by improvements and new methods in doseplanning. Thus both MR and CT and even PET is used to plan and follow up the treatment.



The goal is to kill the cancer cells and at the same time let the healthy cells survive.

You balance on “the knives edge” to reach the goal!

The radiation dose

The goal is to give the tumor a dose that kill the cancer cells, and at the same time let the surrounding healthy tissue survive. Information on therapy doses can be obtained from experiments on single mammalian cells.

The figure to the right can be used to arrive at the dose region which can be used in therapy. The curves demonstrate the results of radiation on single cells. Since it is impossible to observe dead cells, you observe those that survive. The survival curves are usually described by a linear-quadratic equation.

In clinical therapy the total dose is given by a number of smaller doses (each 2 Gy) 5 or 6 days per week. The effective survival curve is like that marked B in the figure. The curve is almost a straight line in this semi logarithmic plot. The sensitivity, defined as the dose that reduce the survival to 37 %, is called D_0 and the dose necessary to kill 90 % is called D_{10} .

For human cells D_0 is of the order 3 Gy. Since the survival curve is a straight line in this semi logarithmic plot we have;
 $D_{10} = 2.3 \cdot 3 = 6.9$ Gy.

We can use the above data to arrive at a dose that can kill the cancer. A tumor consists of 10^9 to 10^{10} cells. In order to kill these cells – that is reduce the survival by 10 decades the required dose would be about 69 Gy.

The amount of radiation used in therapy varies depending on the type and stage of the cancer. The typical dose for a solid epithelial tumor ranges from 60 to 80 Gy, while lymphomas are treated with 20 to 40 Gy. A number of factors are considered in the dose planning, such as the use of chemotherapy and of course surgery.

Today the treatment is planned on computers and the purpose is to give a high dose to the cancer cells and at the same time to minimize the dose to the surrounding healthy tissue.

In order to optimize radiation therapy we can mention two lines; A). To improve the diagnostic side. B). To use radiation that gives the best possible dose distribution (for example protons and carbon ions).

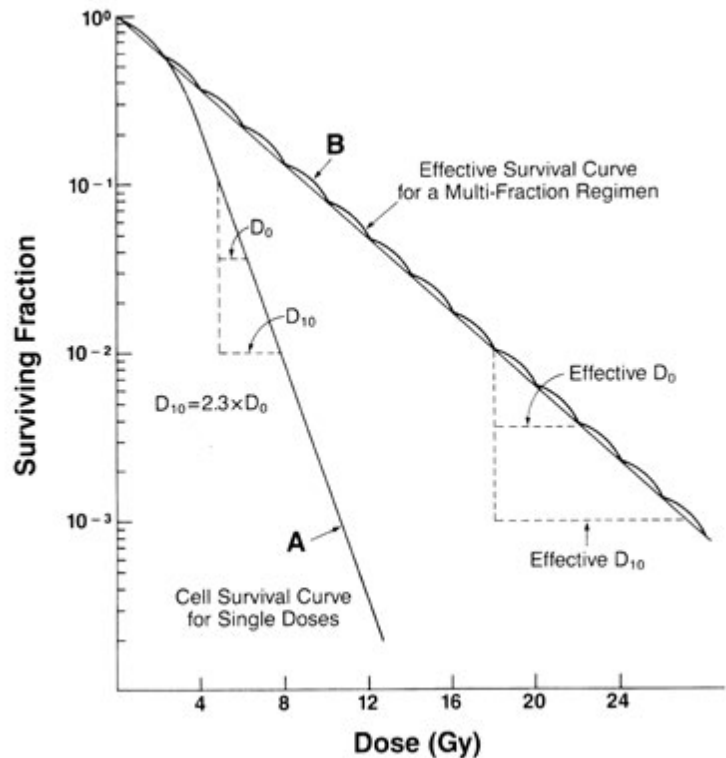

Here is given an example of a survival curve (A). The dose axis is linear and the survival is plotted on a logarithmic scale. The curve can be described by a linear-quadratic equation. After a shoulder it is a straight line in this plot. In curve B the total dose is given by a series of fractions – similar to a radiation treatment protocol.



THE GOAL FOR RADIATION THERAPY

A large dose to the tumor and a small dose to the healthy tissue.

Radiation quality and heavy ion therapy

Most tumors are inside the body – which implies that several centimeters of healthy tissue has to be irradiated on the way to the tumor. The guidelines for treatment are connected to the depthdose curves for the different types of radiation. We have presented depthdose curves on page 219 for x- and γ -rays and on page 29 for α -particles and other charged ions. On page 77 we also present a depthdose curve for carbon ions (stripped for all 6 electrons).

When you switch from x-rays (or bremsstrahlung) to ions (nuclei stripped for electrons) you get a completely new depthdose curve which is outlined in the illustration to the right. The energy deposition along the track (dE/dx) can be described by the Bethe-Bloch equation. In a simple form it can be given as;

$$\frac{dE}{dx} \approx k \frac{z^2}{v^2}$$

Here z is the particle charge (for protons $z = 1$, for α -particles $z = 2$ and for carbon ions $z = 6$). The speed of the particle is given by v . You can easily see that when the particle slows down (v goes to zero) the energy deposition (or rather the dose) goes up. The result is the famous **Bragg-peak**. The Bragg peak can be very sharp – down to millimeter size. It is sharper for carbon ions compared to protons. The depth in the body for the Bragg peak is determined by the energy of the particles. The technology with proton and heavy ion therapy is excellent to fulfil the requirement of maximum dose to the cancer and minimum dose to the healthy tissue. In the beginning there was a lack of diagnostic methods to position the patient and the tumor in order to attain maximum effect of the Bragg peak. Furthermore, we could not follow the results of the treatment. Today we have techniques like CT and PET which has brought the radiation therapy to a new level. With this type of therapy it is possible to spare healthy tissue—for instance, the eye, the base of the skull, the prostate, and tumors very close to sensitive organs. Ion therapy is especially good with large tumors that wrap around critical structures.

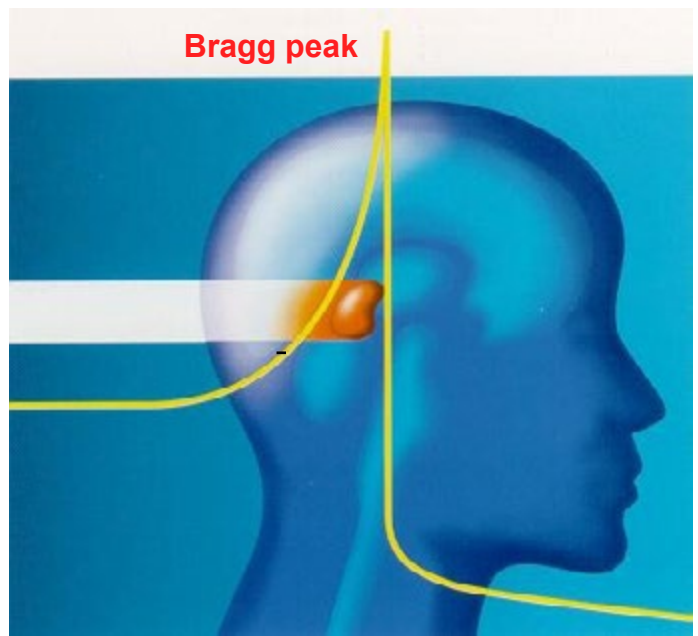

Today we have techniques like CT and PET which has brought the radiation therapy to a new level. With this type of therapy it is possible to spare healthy tissue—for instance, the eye, the base of the skull, the prostate, and tumors very close to sensitive organs. Ion therapy is especially good with large tumors that wrap around critical structures.

History

The history of heavy ion therapy is surprisingly old. It dates from 1946 when Robert Wilson proposed the use of protons and heavier ions for therapy. The pioneering experimental work of Cornelius Tobias and the Lawrence brothers at Berkeley confirmed Wilson's predictions. Between 1954 and 1957, 30 patients were treated on the 184 inch cyclotron at Berkeley.

Proton therapy continued in the USA (Harvard University) and also in other countries like Russia (Dubna) in 1967, Japan (Chiba) in 1979.

In 1990, a facility for proton therapy was set up in the hospital of Loma Linda University in California. They have treated a large number of patients during the years. In 2013, there were a total of 37 proton therapy centers and 6 carbon centers in Canada, China, England, France, Germany, Italy, Japan, Korea, Russia, South Africa, Sweden, Switzerland, and USA. More than 108 000 patients had been treated. A number of new heavy ion therapy centers are planned and under constructions.



Cornelius Tobias
(1918 – 2000)

A strange experiment with heavy ions



In the picture to the right Cornelius Tobias is performing a strange experiment at the Berkeley cyclotron in 1970. The purpose was to explain the mystery behind the peculiar flashes and streaks of light reported by Edwin Aldrin and the other Apollo-11 astronauts after their 1969 moon mission. With a special black hood to prevent light from the outside, Tobias exposed his own eyes to a variety of low-dose beams of α -particles. He saw the same display of lights and they subsequently identified the source of the lights, witnessed by the astronauts, as cosmic rays, a phenomenon that Tobias had predicted nearly 20 years earlier. In the picture John Lyman is lining up the beam. Picture to the left exhibits the entrance of the Lawrence Radiation Laboratory with the 184 inch cyclotron in the background.

Radiation therapy for the future

If we look into the physics for radiation therapy we easily recognize the great possibilities we have if we could use the full capabilities of the Bragg-peak. With a beam focussed to a diameter of about a millimeter hitting the tumor with its Bragg peak would be a dream. With modern diagnostic methods and new accelerators this goal will be reached.

In November 2009 a therapy center in Heidelberg, Germany was opened. In the picture next page you see an outline of this center. The building is half-buried in the ground to minimize radiation exposure for the environment. You can follow the beam which is outlined by a red curve. We start from the left with the ion source and a linear accelerator. The beam enter the synchrotron with a circumference of 65 metres, which can accelerate protons, alpha particles, or nuclei of carbon and oxygen to final energies of 50 to 430 MeV/nucleon.

This implies that protons can be accelerated to energies from 50 to 430 MeV. However, for carbon ions with 12 nucleons, the energy is in the range from 600 MeV to 5.16 GeV.

The heavy-ion beam, which is focussed to a diameter of about a millimeter, is steered by magnets to one of two treatment places, or into a big installation of bending magnets, the so-called “gantry”. The gantry allows the beam to be directed from any direction of a vertical plane into one point.

Heidelberg Ion-Beam Therapy Center (HIT) Germany

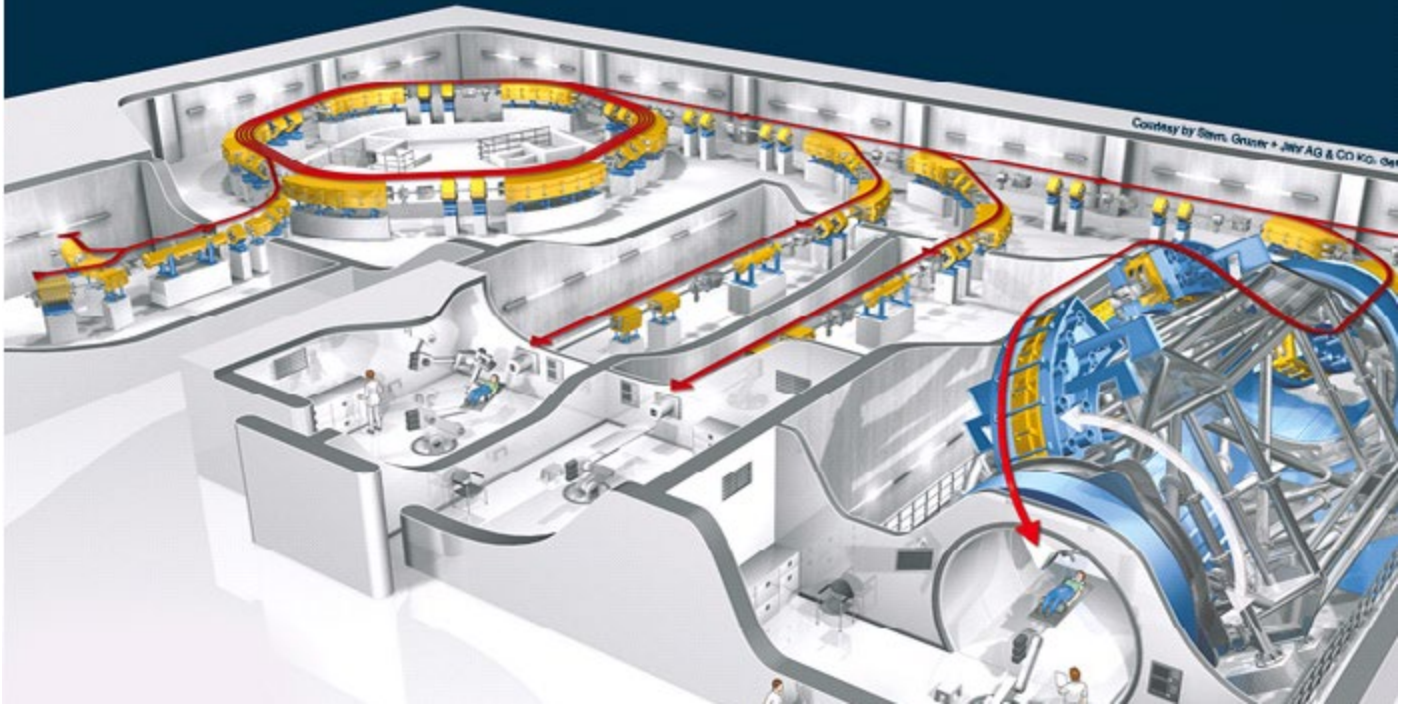

Modern brachytherapy

On page 218 we described the beginning of brachytherapy. Radium was used and the treatment time was usually a few days which included a number of problems with regard to safety for the people around the patient.

Now all use of radium is over and a number of new isotopes have been introduced. The sources are sometimes formed as seeds (0.8 mm in diameter and 4 – 5 mm in length). The treatment can be divided into; a) High dose rate (HDR), b) Low dose rate (LDR) and c) Permanent implants. In the table below an overview of different isotopes, radiation and half lives is given.

Isotope	Radiation	Half life $T_{1/2}$
Ra-226	Average 0.83 MeV	1620 years
Co-60	1.17 and 1.31 MeV	5.26 years
Cs-137	0.66 MeV	30 years
Au-198	0.42 MeV	2.7 days
Ir-192	0.38 MeV	73.8 days
I-125	28 keV EC. γ + x-rays	60 days
Pd-103	21 keV EC. x-rays	17 days
Cs-131	29 keV EC. x-rays	9.7 days

For all these isotopes it is the γ -radiation that is used. It can be noted that the isotopes I-125, Pd-103 and Cs-131 decay via electron capture (EC) and that the emitted radiation is a combination of γ -radiation and characteristic x-rays – because one of the orbital electrons is captured by the nucleus and leaves a hole that is filled with other electrons.

Brachytherapy is used to treat several types of cancer like cervical, prostate, breast, and skin cancer. Brachytherapy can be used alone or in combination with other therapies such as surgery.

Let us give a couple of examples.

Prostate cancer

Prostate cancer can be treated in several ways. One possibility is to use brachytherapy. In the case of LDR I-125 or Pd-103 in the form of small seeds are placed directly into the prostate as shown in the figure to the right. The seeds are guided by a ultrasound probe in rectum. The seeds are permanently in the prostate and the radiation is given mainly during the first half life of the isotope.

Another method is HDR radiation using Ir-192 in the form of an iridium wire. A much stronger source is placed into the prostate and taken out again.

We have also to mention that prostate cancer can be treated with proton therapy. The Loma Linda center in California have used this technique with success for a number of patients.

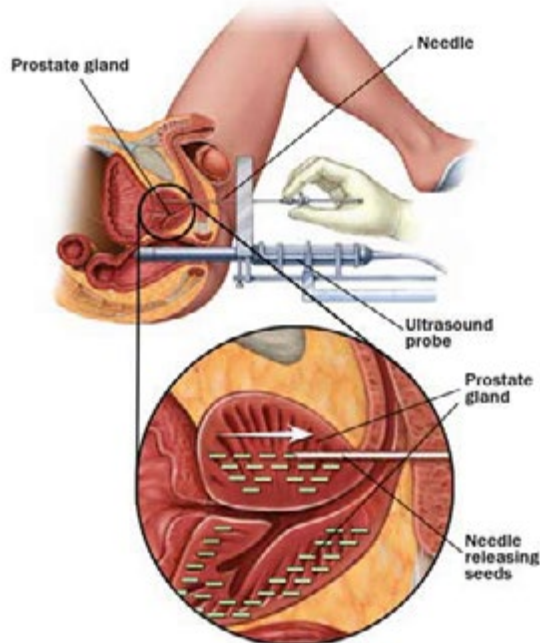

Cervical cancer

Three methods can be used to treat cervical cancer: surgery, chemotherapy, and radiation therapy. In the case of brachytherapy the isotope Ir-192 can be used with a dose-rate (HDR) of the order 12 Gy per hour.

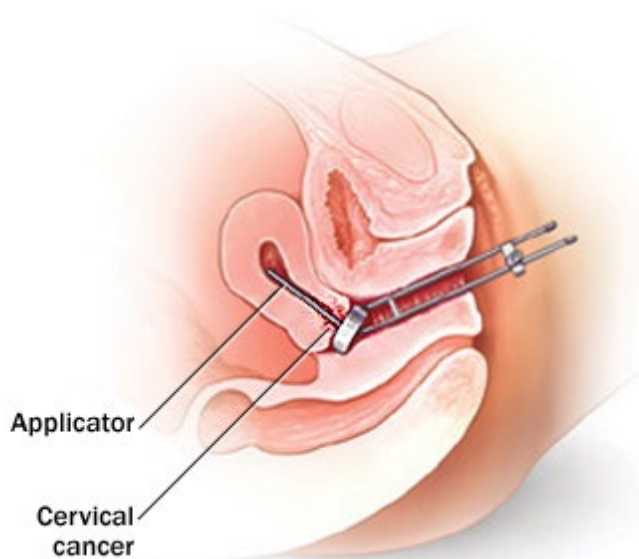

Conclusion

The table above demonstrate the development within brachytherapy. In the beginning only radium was available. This source has γ -radiation with an average energy of 830 keV. The advantage of brachytherapy is that the source is close to the tumor, – and due to the inverse square law this treatment would give a good dose picture.

With sources such as I-125, Pd-103 and Cs-131 the photon energy is down to 20 – 30 keV. This radiation has a much shorter range in tissue and the requirements for therapy – maximum dose to the tumor and a small dose to the healthy tissue – is far better. Furthermore, the half lives are of the order days and the radioactive seeds remain in the body.

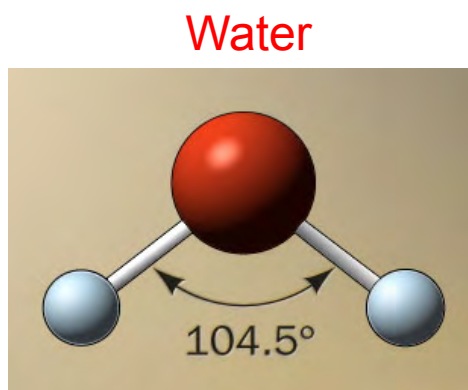

Chapter 11

Radiation Damage to Biomolecules — From water to DNA

In this chapter we shall discuss some of the basic mechanisms for the action of radiation on biological molecules – from water to DNA. In the next chapter we shall discuss the radiation effect on cells and animals and humans.

The radiation research field include physics, chemistry, biology and medicine, and it starts with the absorption of radiation. The initial processes are given in the figure below. The radiation results in a number of “*primary products*”. These products (ions, excited molecules and free radicals) are very reactive with lifetimes in an ordinary cell of the order of a fraction of a second. Their reactions with molecules in the cell result in secondary processes which finally yield a macroscopic result such as cell death, cancer or genetic change.

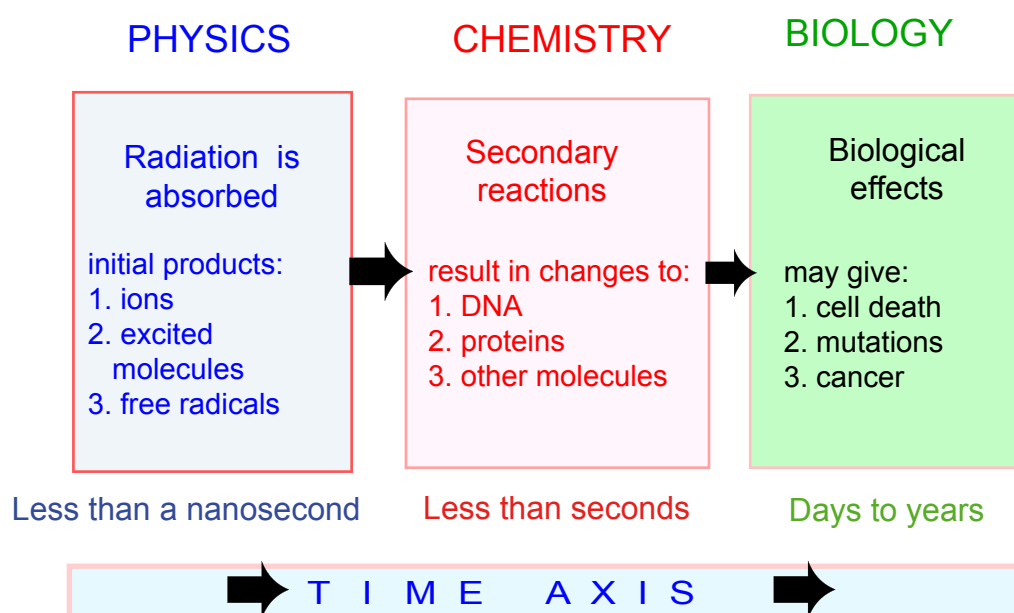

In this figure is outlined some of the products and secondary reactions that take place when a biological system is irradiated. We intend to discuss some of the fields given above. The fields of study at the University of Oslo are mainly connected to the physical aspects and to the biological mechanisms. In the physical studies the electron spin resonance (ESR) technique has been used and for the biological mechanisms living cells cultivated at 37° C have been used.

The field of radiation biology was first promoted in the excellent book of Douglas Edward Lea from 1946 (*Actions of Radiations on Living Cells*).

Because it is not possible to cover all the interesting areas of research, the goal here is to present selected topics that will provide a sense of the scope and the progress being made.

Radiation Biophysics

The effect of any ionizing radiation starts with an interaction between radiation and the molecules in the cell. There are two different types of interactions:

- **Direct effect**

The effect is observed in the same molecule where the primary absorption occurs.

- **Indirect effect**

In this case the radiation energy is absorbed in another molecule (mainly water), resulting in the formation of reactive products that subsequently react with other molecules in the system.

In a dry system (without water), the direct effect occurs, whereas in an aqueous system the indirect effect dominates. Reactive water radicals are formed that initiate a number of subsequent processes. A living cell consists of about 70% water and 30% other materials. In such a system, the direct and indirect effects are approximately equally important.

Study of the primary radiation products is difficult because the life times of initially formed products are only milliseconds or shorter. There are two main strategies for studying these short-lived reactive products (called unstable intermediates):

1. Rapid techniques

The approach is to observe unstable intermediates in a very short time span before they disappear. In one technique, unstable intermediates are created by a short intense pulse of radiation (less than a nanosecond, 10^{-9} s). The intermediates are then detected by a very rapid measuring system, typically looking at changes in properties such as light absorption, emission, and conductivity. This approach is called pulse radiolysis.

2. Stabilizing methods

The lifetime of unstable intermediates can be increased by two different methods. Either using dry samples (remove the water) or using low temperatures. At low temperatures the secondary reactions are slowed down or even stopped. Very often this entails using temperatures below -100°C . In order to attain these temperatures, liquid nitrogen with a temperature of -196°C or liquid helium with a temperature of -269°C is used to cool the sample. Experiments with liquid helium are very informative but difficult to do. The intermediates are first stabilized at extremely low temperatures. Then by slowly warming it is possible to observe the reactions as they unfold. This procedure makes it possible to study the secondary reactions.

For a number of years research groups have studied unstable intermediates (free radicals) formed in hormones, proteins and DNA with the method *electron paramagnetic resonance* or *electron spin resonance* (EPR or ESR). We have already mentioned this technique used for dose measurements (see page 78 – 83). Some of the main points for magnetic resonance are given on pages 204 – 207.

On the following pages we shall give the interested reader a short review of this powerful technique. We shall in particular mention the work carried out in our department at the University of Oslo and all the good colleagues we have had since the start in 1960.

EPR – ESR – the study of radicals formed by radiation

The history of magnetic resonance starts in the 1940s. The pioneers were F. Bloch and E. Purcell (NMR) and Y. Zavoisky (ESR)(pages 204 – 207). ESR concentrates on unpaired electrons (free radicals and radical ions). An irradiated sample placed in a strong magnetic field is exposed to microwaves. Under conditions which satisfy the electronic resonance of the free radical, microwaves are absorbed and this absorption yields valuable information about the molecular damage induced by radiation.



The initial products formed by radiation are mainly “*free radicals*”. These products are characterized by having an odd number of electrons and are “paramagnetic”; i.e. they have a magnetic moment μ , which is given by the expression:

$$\mu = g\beta S$$

Here g is a characteristic constant, β is the Bohr magneton (a unit of magnetic momentum) and S is the spin of the electron.

Molecules with magnetic moments behave like small magnets in a magnetic field B . Their energy in the field is given as:

$$\mu \cdot B \text{ or } g\beta S \cdot B$$

S may have one of two values, $\pm 1/2$. Thus, there are two possible energy states. This is the key to understanding the EPR technique. Free radicals in a magnetic field are divided into two groups (the magnetic moments either oppose B or align with B) each group having a different energy.

When the sample containing free radicals is exposed to microwaves of the correct resonance energy, transitions are induced from one energy state to another. The requirement for this is that the microwave energy is exactly equal to the energy difference between the two states. This requirement can be written:

$$h\nu = g\beta B$$

In this equation, the energy is the product of Planck’s constant (h) and the microwave frequency (ν). For a magnetic field of 0.33 tesla (3,300 gauss) resonance occurs at a microwave frequency of about 10 GHz. This frequency corresponds to a wavelength of 3 cm.

An EPR-signal or spectrum is observed when the magnetic field is swept and the resonance conditions are fulfilled. Thus, the EPR spectrum of a sample exhibits the absorption of microwaves versus the magnetic field.

The *shape* of the spectrum yields information on the environment of the unpaired electron and if the electron interacts with neighboring protons and other nuclei. These interactions often make possible the identification of the initial and secondary radiation products. Since the interaction with the neighborhood is anisotropic, it is a goal to study radicals trapped in single crystals. Most of the amino acids and the DNA components (bases, nucleosides and nucleotides) can be obtained and studied in the form of single crystals.

Experiments can be carried out on irradiated samples at a very low temperature where the primary products are frozen and, thereby, stabilized. By subsequent warming the products are released and secondary reactions studied. Thus, the EPR experiments yield :

- 1). Identification of the free radical products formed.
- 2). The concentration of radicals per unit dose (chemical yield).
- 3). The secondary reactions spawned by the initial radicals.

EPR in Norway – a short review

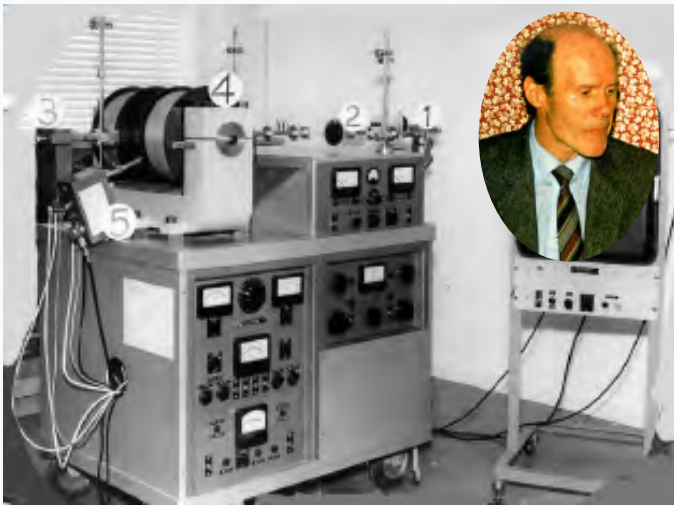

The EPR in Norway started at the Radium hospital in 1957 with a “homemade” spectrometer constructed by Otto Sørensen (left).

In 1970 the activity moved to the University of Oslo and a new JEOL spectrometer was installed (below).



Today two modern spectrometers are in operation (one is shown left). In 2013 we have excellent equipment for ESR studies.



The bottom picture is from Christmas 1979 and shows the old spectrometer with the staff; from left Arnt Inge Vistnes, Einar Sagstuen, Thormod Henriksen og Håkon Theisen.



Colleagues and coworkers

The EPR connected to radiation biophysics started in 1955 at Duke University, Durham, North Carolina.

It was the well known microwave scientist **Walter Gordy** that opened the field. Together with a number of students they studied radiation damage to polycrystalline compounds of amino acids and DNA-bases. They also started the single crystal studies.

Gordy's Phd. students dominated this field for a long time. during the last half century. At the university of Oslo we have collaborated with a number of these students like Wallace Snipes, Chester Alexander, Janko Herak and for a long time Bill Nelson in Atlanta.



Walter Gordy
(1909 – 1985)



W. Snipes



C. Alexander



Janko Herak

Gordy's work initiated ESR-studies in a number of other laboratories around the world. Let us mention some of them. In Europe it started with some comparative measurements to determine the absolute number of radiation-induced free radicals. The groups included was:

Karlsruhe Germany. Carl G. Zimmer urged Adolf Müller and W. Köhnlein to start ESR work. In this group we also can find Jürgen Hüttermann.



Adolf Müller

Stockholm, Sweden. Here Anders Ehrenberg started the ESR studies and he got coworkers like Göran Løfroth, Astrid Gräslund and Anders Lund.

Anders Lund has through all years been one of those that has developed the ESR-technique and has written books.



Anders Ehrenberg

Anders Lund

Anders is a hard working retired professor. To the right with his book "*Principles and applications of ESR spectroscopy*" from 2011.

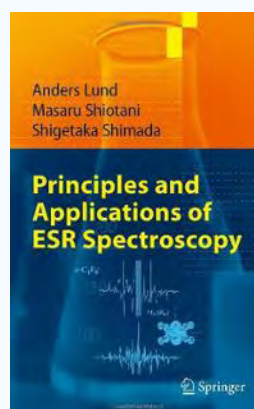

In Netherlands the ESR group consisted of R. Braams and J. ten Bosch.

Buffalo, USA. Here we find a group headed by Harold Box.



Harold Box

EPR at the University of Oslo

The very first master thesis with ESR was in 1961. Svein Prydz studied the radicals formed in amino acids. The first dr. degree in ESR was in 1963 when Thormod Henriksen used the technique to study free radicals in radioprotective sulfur compounds.

In the period from 1960 to 2000 more than 50 master and dr. theses have been taken at UiO. A review (written in Norwegian) of all these students and their work can be found on the address:

http://www.mn.uio.no/fysikk/forskning/grupper/biofysikk/biofysikk_miljofysikk_historikk.pdf

Coworkers: A number of scientists have worked in our laboratory for longer or shorter periods. We would like to mention Bill Nelson, who was a coworker for a number of years.

We also had a long valuable contact with Bill Bernhard in Rochester.



William H. Nelson
(1943 – 2010)



Michael Sevilla and Bill Bernhard

Picture from 1995 – from the celebration of the 100 year anniversary of Roentgens discovery.

Radiation products formed in water

Upon the irradiation of water, radical ions and excited molecules are formed. From these initial products, secondary free radicals are formed. There are two different pathways :

1. Excitation

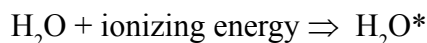

H_2O^* represents an excited molecule. The excited molecule is very unstable and loses its extra energy rapidly by a variety of pathways. One pathway is bond cleavage of the excited water molecule, resulting in the formation of **H** and **OH**. Both these products are free radicals implying that they have an unpaired electron. A known way to present this is by putting a dot to the chemical name like $\text{OH}\cdot$.

2. Ionization



The primary products H_2O^* , H_2O^+ and e^- give rise to three reactive radicals: OH (hydroxyl radical), e_{aq}^- (aqueous or hydrated electron) and the H-atom. In a neutral solution (pH = 7), the relative amounts of these radicals formed are **2.6 : 2.6 : 0.6**, respectively.

Note that the electron ejected by an ionizing event, e^- , is distinct from the aqueous electron, e_{aq}^- . Thus e^- is an electron that is enveloped by a number of water molecules and is relatively stable (for up to milliseconds). The e^- however, is a “dry” electron that still retains some of the excess kinetic energy acquired from the ionizing event.

The dry electron can be solvated to form e_{aq}^- . It may also be trapped in a frozen matrix, and can thus be studied by EPR. The solvated electron may in turn react with a biomolecule such as DNA.

All the initial water radicals, $\text{H}\cdot$, e_{aq}^- and $\text{OH}\cdot$ have been observed with the EPR-technique.

In 1955, R. Livingston, at Oak Ridge, showed that H-atoms were formed and stabilized in frozen solutions of sulfuric acid (H_2SO_4). This experiments have been repeated and the data are given in the left figure below. H-atoms are formed in all aqueous solutions. In order to stabilize the species low temperatures are needed. At 77 K they are stabilized both in low and high pH-solutions. For pure water we must go to lower temperatures.



Ralph Livingston

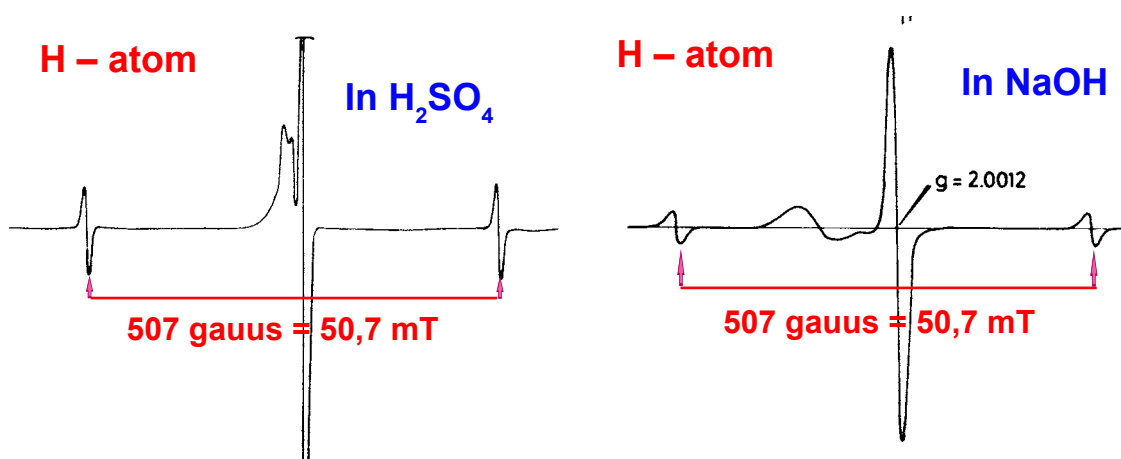

The EPR-spectra above exhibits the “fingerprint” of the H-atom. The two lines with a splitting of 507 gauss (50.7 mT) is the ESR-spectrum of the H-atom. The frozen samples were both irradiated and observed at 77 K. The line with the g-value of 2.0012 in the right spectrum is the evidence of a solvated electron (see more below).

The solvated electron

In 1954, R. Platzmann suggested that the aqueous electron is a radiation product. This theory was confirmed by J. Boag and E. Hart in 1962. They observed the absorption spectrum of the aqueous electron in pulse radiolysis experiments.

A year later the hydrated electron was observed using EPR by T. Henriksen in experiments on frozen solutions of NaOH (see figure below).

Pellets of NaOH in both H_2O and D_2O were irradiated and observed at $-196\text{ }^\circ\text{C}$. The “fingerprint” of an electron is a single line at a g-value of 2.0012. The position of the line in the magnetic field tells us that the electron is kept in a cage of water molecules. If the electron was completely free the g-value would have been 2.0023 (the so-called Lamb shift results in this deviation from 2). The cage itself has an influence on the broadness of the line. Thus, in a cage of heavy water (D_2O) the line is more narrow. If Na is dissolved in liquid ammonia, electrons are formed and trapped (bottom spectrum). In this case the cage consists of NH_3 molecules and the electron is more free. The line has a slightly higher g-value and is more narrow.

The OH-radical

The $\text{OH}\cdot$ radical has a far more complicated EPR-spectrum. It was identified by T. Gunter (Berkeley) in experiments on irradiated single crystals of water in 1964.

The three primary products formed in water are the starting point for a number of radiation-induced effects in biological systems. One of the goals in radiation research is to follow the processes which take place as these initial products react and yield changes to important biomolecules such as proteins and DNA.

In the case of radicals formed from proteins, DNA or the constituents of these macromolecules, the spectra are much more complicated. Through advanced techniques such as EPR and ENDOR, valuable information is being learned about the fast chemical processes initiated by ionizing radiation in biomolecules. We shall first give you a glimpse of the EPR-work on amino acids and proteins – and see the correlation between radical formation and enzyme inactivation as the biological end point.

Proteins and amino acids

The EPR-work on amino acids and proteins have given some information that can be mentioned.

1. Secondary radical reactions can be studied, – both in frozen aqueous solution as well as in crystalline compounds.
2. **The radicals formed are independent of LET.** That is; the same radical species are formed whether we use x-rays or heavy ion beams. However, the number of radicals stabilized vary with LET. We give one example of such experiments.
3. The formation of radicals in enzymes can be correlated to a biological end point such as inactivation.



Jack Boag
(1911 – 2007)
(photo from 1957)

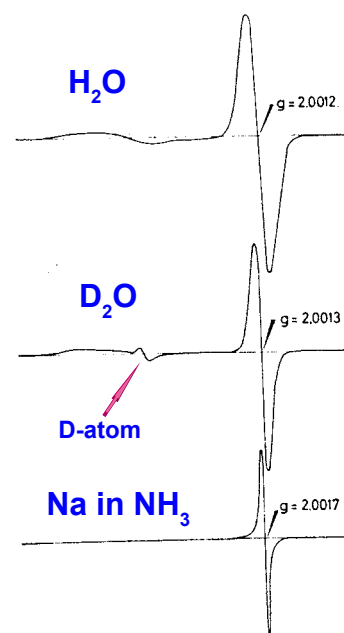

Trypsin – radicals and inactivation

Trypsin consists of a single chain polypeptide of 223 amino acid residues. The amino acid sequence of trypsin is crosslinked by 6 disulfide bridges. Trypsin is a member of the serine protease family. The active site of trypsin include histidine and serine. Trypsin will cleave peptides on the C-terminal side of lysine and arginine amino acid residues.

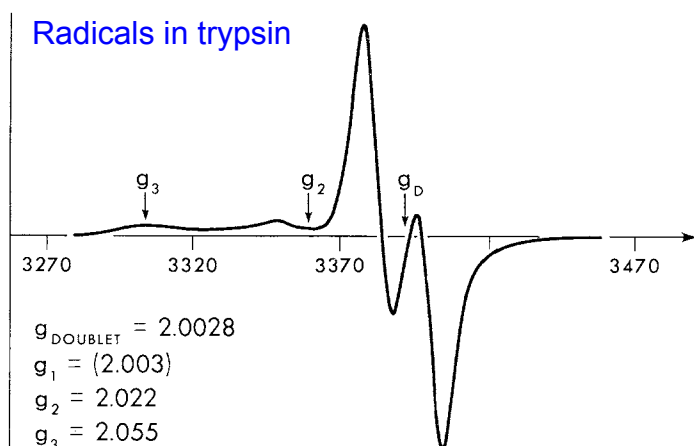
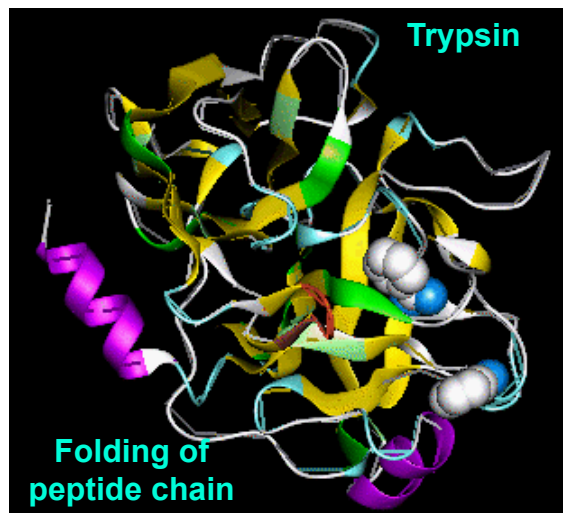

When trypsin is irradiated the ionizations and excitations are evenly distributed in the molecule (determined by the electron distribution). **Secondary reactions** occur and we end up only with two types of radicals as shown in the EPR-spectrum to the left. The doublet is due to a backbone radical, whereas the resonance with the three g-values (2.003, 2.022 and 2.055)

is due to a sulfur radical – probably located to the disulfide bonds that are important for the integrity of the molecule.

Correlation between radicals and a biological end point

The biological effect of radiation is the results of the mechanisms initiated – that is the ionizations and the excitation of the molecules. The free radicals formed are “intermediate products”. We assume that the secondary reactions yield the biological effects. Below we present some old experiments which demonstrate the connection between the free radicals formed in enzymes (here trypsin) and the inactivation of the enzyme (in the solid state). The experiments are carried out with the Berkeley heavy ion linear accelerator (HILAC) in the beginning of the 1960-ties by Tor Brustad (the inactivation experiments) and Thormod Henriksen (the ESR-measurements).

Inactivation. The inactivation curve for trypsin is exponential with regard to the radiation dose. The parameter used for inactivation (the yield of inactivation) is therefore the reciprocal of the D_{37} dose. The variation of the inactivation with increasing LET is given in the figure on the next page.

Temperature. Another type of experiments is also given in the lower figure (next page). The dry enzyme was irradiated with carbon ions at various temperatures. All measurements were carried out at room temperature. Again there is a striking correlation between the radical formation (the secondary radicals – mainly the sulfur radicals) and the inactivation.

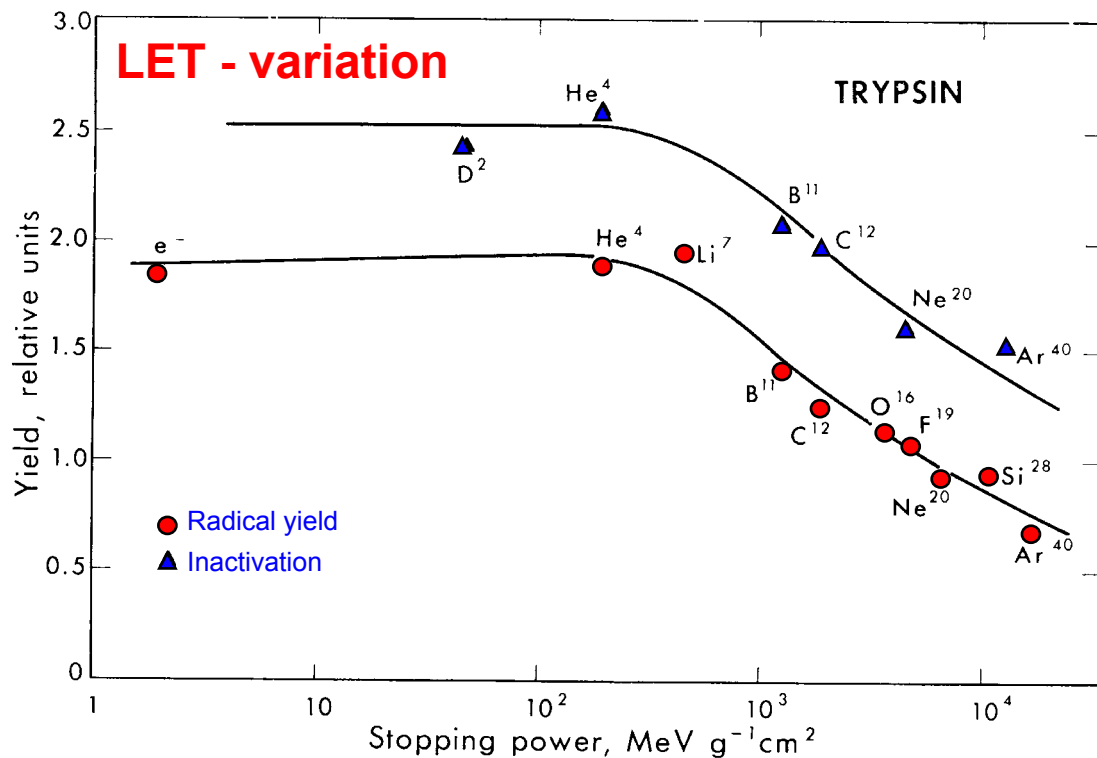

In this figure the inactivation of trypsin (in the dry state) is given as a function of LET. In the lower curve the formation of secondary radicals (mainly sulfur radicals) are given. Both the inactivation yield and radical formation yield is in the figure given in relative units. It appears that the data exhibits the same curve shape.

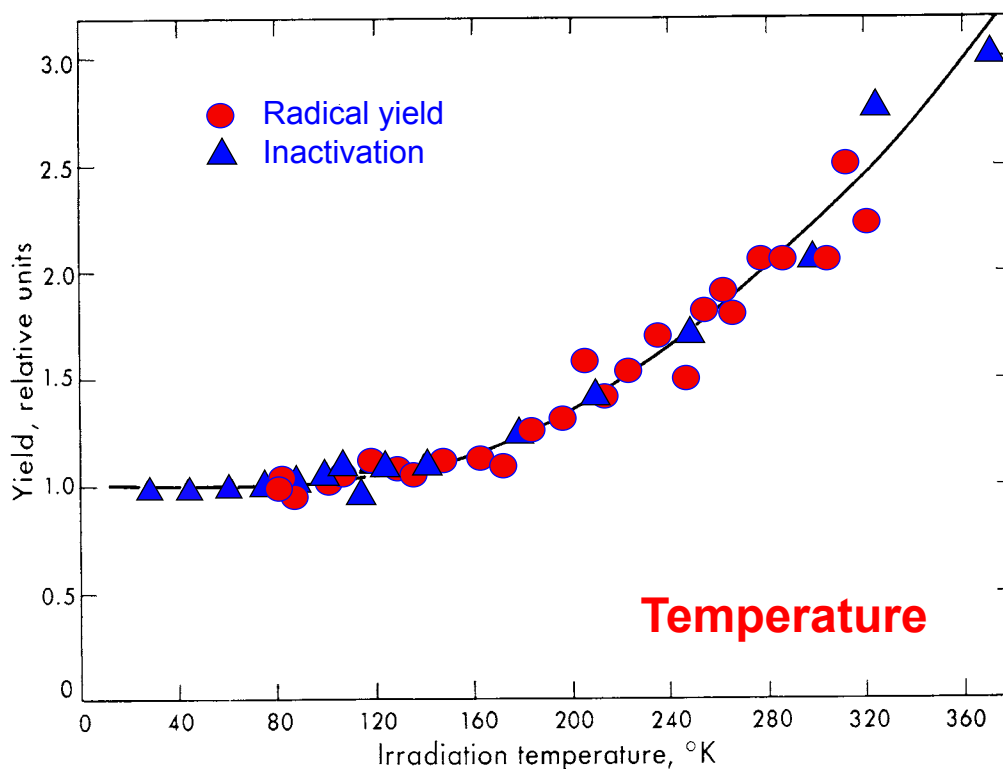

In this figure the inactivation of trypsin is compared to the formation of secondary radicals as a function of the irradiation temperature. The radiation is carbon ions with energy 10.4 MeV/nucleon. The same radiation equipment was used in the two types of experiments. Furthermore, all observations are carried out at room temperature. Thus it is a correlation between the secondary radicals formed and the inactivation.

Conclusion

The old experiments presented above suggest that the inactivation of trypsin is due to the formation of secondary radicals – *probably a radical with the spin density localized to the disulfide bonds*. A rupture of disulfide bonds may unfold the peptide chains and thus inactivate the molecule.

A large number of EPR-experiments have been carried out on amino acids and proteins. We encourage the reader to consult the publications from the biophysics group.

Although proteins are damaged by radiation, the consequences are generally **not** significant. This is because proteins exist in multiple copies and, if needed, new copies can be generated using the information stored by the DNA (deoxyribonucleic acid). *But what if the DNA is damaged?*

Radiation damage to DNA

The effects of radiation on chromosomes, genes and DNA have been a major focus of research. The reason for listing these three names together is that genetic information is encoded by DNA molecules that in turn are packed as chromosomes. Scientists have studied the effects of radiation, chemicals, ultrasound and UV that alter the molecular structure of DNA. Of considerable importance is the correlation between the DNA damage and the subsequent biological effects. A correlation is anticipated because the information carried by DNA is essential for cellular replication and differentiation. Since DNA is extremely important for the last part of this book and for biology we shall give a short history of the experiments that resulted in the Watson – Crick model.

History and structure of DNA

In order to discuss radiation damage to DNA, we shall first give a short review about the history and some details about the DNA structure .

The research done to understand the structure and significance of the *hereditary molecule* is exciting and a number of Nobel prizes have been awarded to individuals working in this area.

In the years 1951 to 1953, work on determining the molecular structure of DNA reached a milestone of epic importance. A biologist, James D. Watson, and a physicist, Francis Crick, working at the Cavendish laboratory in Cambridge, England formulated the double helix model for the three dimensional structure of DNA. Publication of their paper "*Molecular Structure of Nucleic Acids*" in *Nature*, in 1953, brought them instant acclaim. The structure provided immediate insight into the relationship between DNA's structure and its function.

Watson and Cricks model work was based on X-ray diffraction studies by Furberg and Franklin and chemical work by Chargaff. The most important work was carried out Rosalind Franklin. Unfortunately, Rosalind died in 1958, only 37 years old, and she never earned the Nobel prize she deserved.

Watson and Crick presented the DNA model in the English Journal, *Nature* on April 25, 1953. The model was relatively simple and provided insight into how genes work and how hereditary information is transmitted.

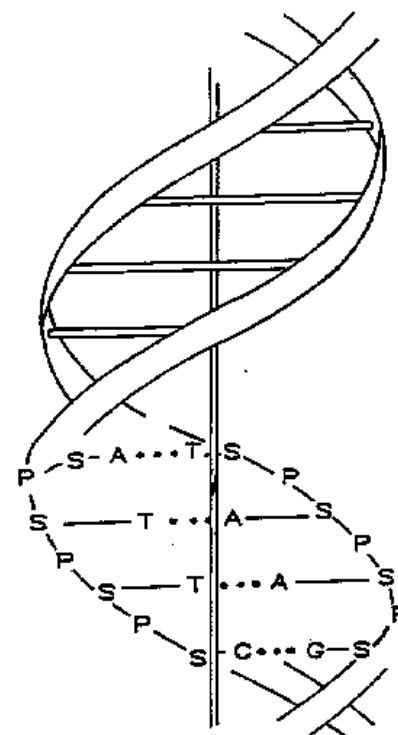

It all started with Friedrich Miescher who discovered DNA more than 100 years ago. It was early realized that chromosomes contained genetic information, but it was first through the work of Griffith and Avery on bacteria that DNA was found to be the key molecule.



Friedrich Miescher
(1844-1895)

DNA was isolated, analysed and recognized as a unique macromolecule in 1869 by Friedrich Miescher, Switzerland.

He studied leucocytes and was able to isolate undamaged nuclei free of cytoplasm. Miescher found that his new substance, which he called nuclein, contained 14 percent nitrogen, 3 percent phosphorus, and 2 percent sulfur. He concluded that the substance was not a protein.



Fredrick Griffith
(1879 – 1941)

In 1928, Fred. Griffith demonstrated that one type of *Streptococcus pneumoniae* bacterium (called R) could inherit the properties of another type (called S) by attaining an extract from dead S-bacteria.

This “*transforming principle*” suggested that the extract contained the heredity molecule – and it was of great importance to identify it. This important work was carried out by Oswald Avery, Maclyn McCarty and Colin MacLeod in 1944.



Oswald T. Avery
(1877 – 1951)



Colin MacLeod
(1909 – 1972)



Maclyn McCarty
(1911 – 2005)

Oswald Avery (already emeritus, 67 years) worked with MacLeod and McCarty at Rockefeller Institute. They showed that the “effective” substance in Griffiths experiment was the DNA-molecule and that DNA is the carrier of genes in the cell.

We also have to mention that Alfred Hershey and Martha Chase in 1952 confirmed the conclusion in experiments with radioactive tracers (see page 194).

Today it is well known that DNA is the important molecule that it seems difficult to appreciate the magnitude of these scientific achievements. The above mentioned research paved the way for the intense experiments from 1951 – 1953 which resulted in the double helix model.

On the road towards the double helix we have to mention a couple of other scientists that made significant contribution.

In 1950 Erwin Chargaff found that a peculiar regularity in the ratios of nucleotide bases.

In the DNA of each species he studied, the number of adenines approximately equaled the number of thymine, and the number of guanines approximately equaled the number of cytosine. This suggests that the bases exist in two base pairs (Chargaff's rules):

A – T and G – C

The physical method used was x-ray crystallography. In order to attain information of the structure of the molecule the sample should be in the crystalline form – preferably a single crystal.

In the way towards the DNA-structure we would mention two significant crystallographers and their work; namely Sven Furberg and Rosalind Franklin.

Sven Furberg worked on the structure of DNA components. In the work on cytidine (see the model of the molecule at the bottom of the page) he found that the base plane (the plane of cytosine) was perpendicular to the sugar molecule. Crick mentioned this observation in the following way; “*a remarkable achievement for the time*”.

Based on the structure of cytidine, Furberg suggested a model of DNA consisting of a single stranded helix. In his model DNA was a long chain of sugar molecules (marked S) and phosphate groups (marked P) ; -S-P-S-P-S-P-. The base planes were perpendicular to the axis of the helix and the distance between the base planes was 3.4 Å (1 Å = 10^{-10} meter). This model was correct in most aspects but lacked the important idea of a double stranded helix.

Rosalind Franklin was a brilliant crystallographer. She worked with DNA and was able to distinguish between two types of DNA depending on the hydration. Both types have a helical structure.

To the right is the famous picture (Photo 51) taken by Rosalind Franklin in 1952.

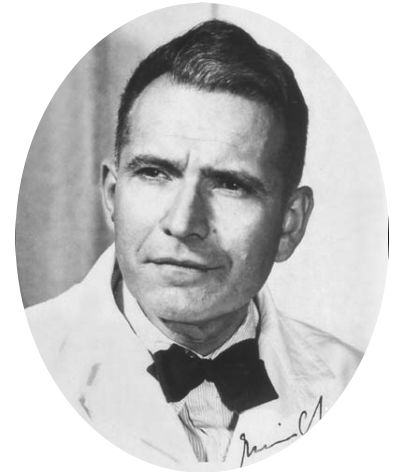

Erwin Chargaff
(1905 – 2002)



Sven Furberg
(1920 – 1983)



Rosalind Franklin
(1920 – 1958)

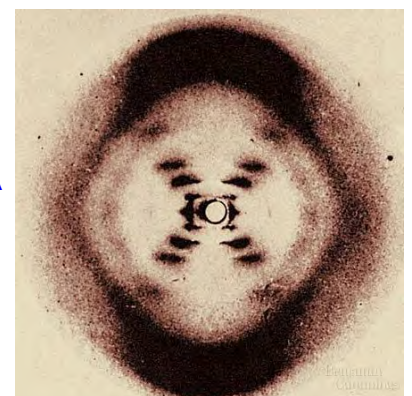
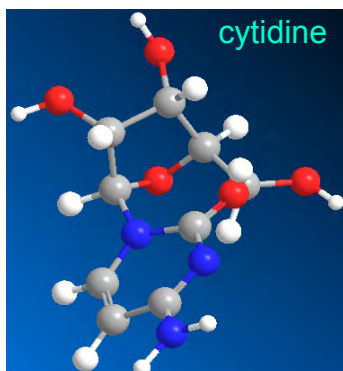

The diffraction image of DNA, observed by Franklin provided the key missing piece of information for Watson and Crick's discovery of the structure of the DNA molecule. The DNA-model they suggested is based on the work carried out by Chargaff, Furberg and foremost Franklin and the "Photo 51".

The last step towards the structure of DNA was carried out in the famous Cavendish Laboratory in Cambridge. This laboratory is connected to a number of significant discoveries and was headed by James Clerk Maxwell, Lord Rayleigh, J.J. Thompson, Ernest Rutherford and from 1938 Lawrence Bragg. He was an excellent X-ray crystallographer and the laboratory studied the structures of biological molecules – like myoglobin and hemoglobin (Kendrew and Perutz). In this laboratory Francis Crick already worked when James Watson came from the United States and they started to build models of the DNA molecule. In the spring of 1953 they arrived at the model shown in the famous picture below.

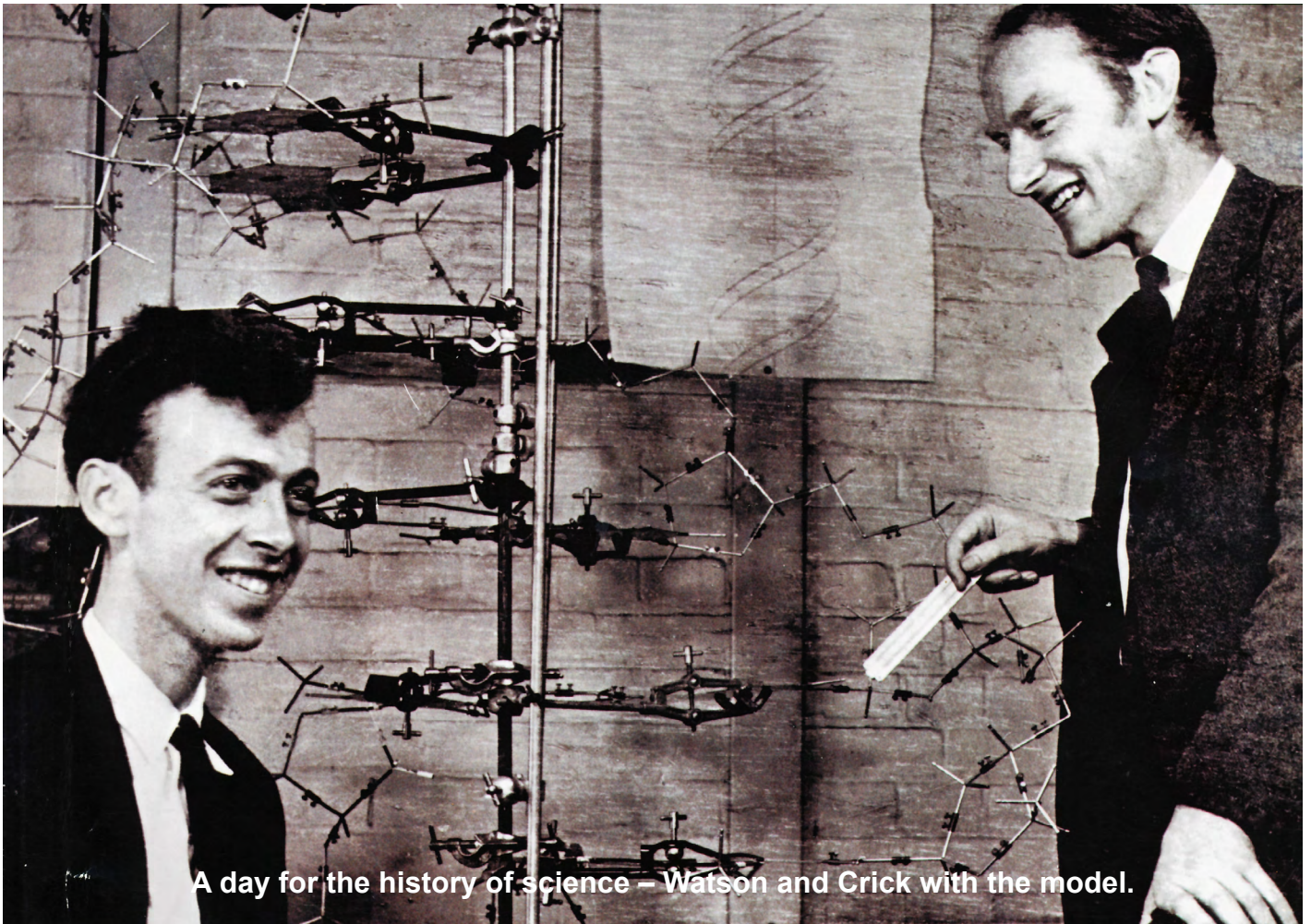

They published the model in the paper "*Molecular Structure of Nucleic Acids*" in *Nature*, in 1953. The paper was only a single page and few, if any papers have had such an impact. Watson was only 25 years old and Crick was 37.

The important difference between this model and the model suggested by Furberg is that it is a **double helix**. This fact is important for replication. Watson and Crick expressed it as follows; "*It has not escaped our notice that the specific pairing we have postulated immediately suggests a possible copying mechanism for the genetic material*".

DNA structure

DNA is a long molecule (a polymer) which has 6 different building blocks, the 4 bases; cytosine (C), thymine (T), guanine (G) and adenine (A), as well as a sugar molecule (S) and a phosphate group (P). Phosphate, sugar and a base form a nucleotide and DNA is made up of two long chains of nucleotides.

If all the DNA in a single human cell was tied together and stretched out, it would be approximately 2 meters long. One strand of DNA binds to the other strand through hydrogen bonds that extend between base pairs. Thus, C binds specifically with G and A binds with T forming the C – G and A – T base pairs.

The human double helix contains about 6 billion base pairs. Three adjacent bases (a triplet or codon) on one strand code for a certain amino acid in a protein. If a protein consists of 200 amino acids, the DNA that codes for this protein consists of at least 600 bases, *i.e.*, 200 triplet codons. ***This is a gene.***

If an error arises in one of the bases, a “wrong” amino acid may be inserted into the protein. This may change the properties of the protein. An example of an error of this type can cause “sickle cell anemia”, a dreaded sickness mainly found in Africa.

Human beings vary because of differences in the DNA base sequence. This can be demonstrated in so-called DNA-tests. Such tests are now used for positive identification of people (for example in criminal court cases).

Scientists around the world are engaged in research on how external agents such as radiation and chemicals induce changes in DNA. Some changes kill the cell, others change the cell and cause cancer, while other changes are without observable effects.

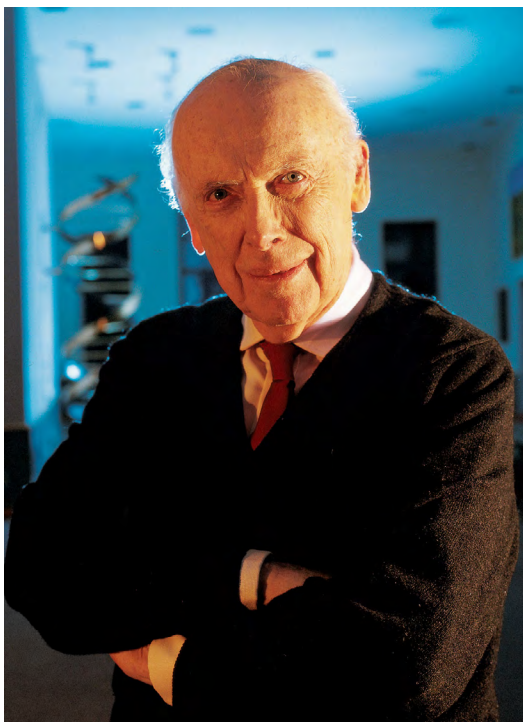

James Watson
(1928)

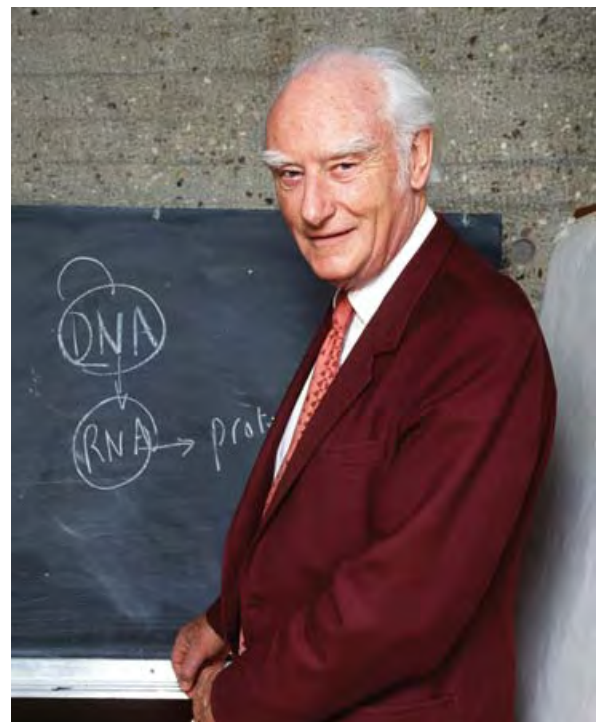

Francis Crick
(1916 – 2004)

In a human cell, the DNA-thread is packed into 46 units (the chromosomes). With the use of particular methods it is possible to study the chromosomes under the microscope when the cells are in division (in mitosis).

Growth takes place by division of cells. Each cell goes through a cycle and, before division, the content of DNA must double. The goal is to make the new DNA identical to the old DNA in the *replication process*. It is in fact, fantastic to realize that very few significant errors normally arise. Some errors actually arise routinely but they are immediately recognized and repaired. We shall return to the repair mechanisms and other defense mechanisms in the next chapter.

If an error arises that is not repaired or if it is misrepaired and the cell still divides, we have a mutation. If the mutation occurs in an ordinary cell in the body it is called a *somatic mutation*. If the cell is capable of reproduction, it may lead to cancer.

A mutation in a sex cell is called a *genetic mutation*. Such mutations can take place spontaneously and people have for a long time speculated about the mechanisms. One way of producing genetic mutations is by radiation.

The evolution of species requires mutations. Thus, a slow development of the species is based on accidental mutations. Research work seems to indicate that the frequency of the spontaneous mutations is increased by radiation and it has been a long range goal to determine the dose which doubles the mutation rate for animals and humans. This is called the *doubling dose* (see chapter 13).

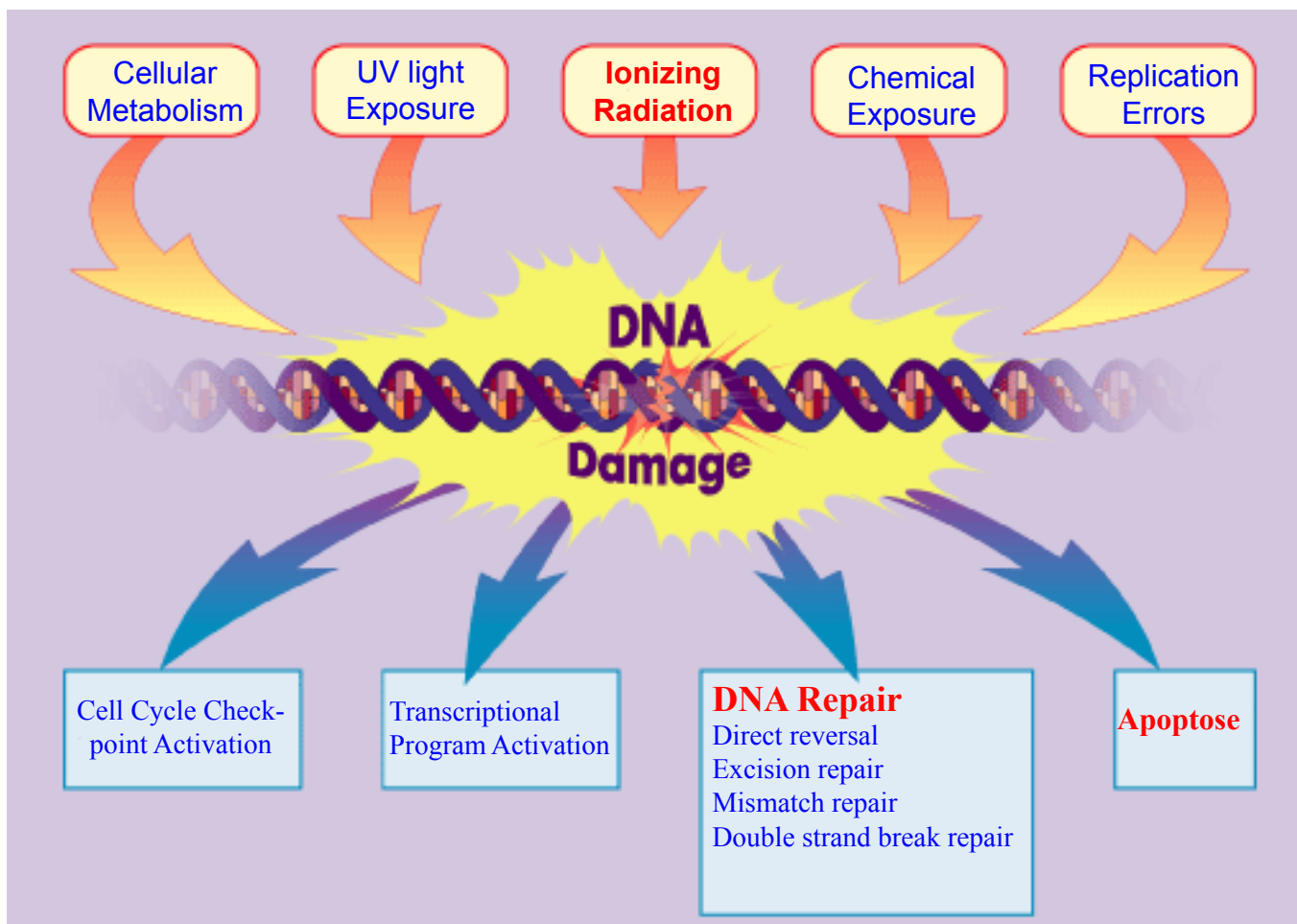

An illustration of how different causes can give damage to the DNA-molecule. The largest number of damages comes from the life processes going on (cellular metabolism). This damage is called *endogenous damage*. Damage from UV, ionizing radiation and chemical substances are called *exogenous damage*. In the following we shall concentrate on the damage caused by ionizing radiation.

Radiation damage to DNA

The most important types of damage to the DNA molecule, induced by radiation, are outlined in the figure below. There are four common types of damage:

1. Single strand breaks

A single strand break is simply a break in one of the sugar-phosphate chains. This damage is usually simple to repair and, in experiments, it has been shown that approximately 90% of the single strand breaks are repaired in the course of one hour at 37° C.

2. Double strand breaks

This type of damage involves both strands of the DNA helix, which are broken opposite to each other or within a distance of a few base pairs. This type of damage (also called a clustered damage) would kill the cell and in experiments with bacteria a correlation is found between double strand breaks and cell death (David Freifelder in the 1960-ties).

Double strand breaks are more difficult to repair correctly. However, they actually are. The DNA-molecule is packed together with proteins supporting the structure and preventing the pieces from falling apart, even when breaks occur on both strands of the helix. There are in fact a number of mechanisms that complex organisms (such as humans) have evolved for repairing double strand breaks. But as one might guess, this type of break is more difficult to repair and does correlate with cell death and observable damage to chromosomes.

3. Base damage

Experiments indicate that the radiation sensitivity varies from one base to another. After an initial ionization, rapid electronic reorganizations take place with the result that the damage is transported to certain regions of the macromolecule. The base guanine is particularly sensitive.

Damage to a base is one of the starting points for a mutation. If a base is changed, information may be lost or changed. As the result of a misrepair or no repair, the altered triplet codon is likely to lead to insertion of the incorrect amino acid in the protein. In turn, the changed protein might not function properly.

4. Pyrimidine dimers

Pyrimidine dimers are also examples of clustered damage. In this example, two adjacent bases, T and T, on the same strand have been chemically altered. This is but one out of a myriad of possibilities. All the possibilities have the common feature that two or more damaged sites lie in close proximity to one another.

We shall return to repair mechanisms, but would like to mention the problems posed by clustered damage. One of the strands is needed to replicate the adjacent strand. When both strands are damaged at the same site there is no template to work from. This is in contrast to damage such as a single base alteration or a single strand break.

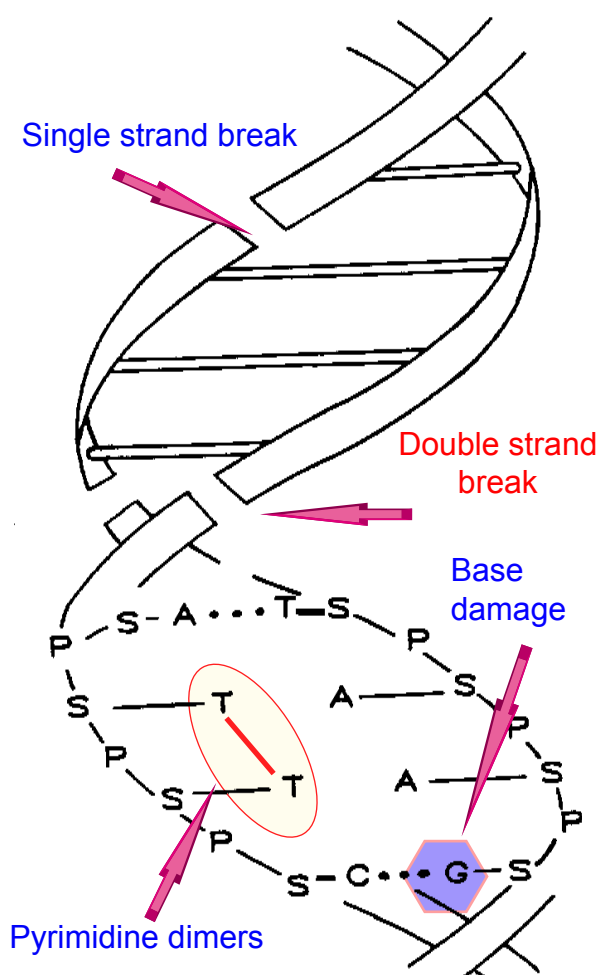

EPR work at UiO

The EPR-group at the University of Oslo has been engaged in studies on the damage to the DNA and its components, i.e. bases, nucleosides, nucleotides and larger fragments. The studies have included work at temperatures from that of liquid helium and up to room temperature.

A large number of students working for their master degree and dr. degree have been guided by Einar Sagstuen and Eli O. Hole. You can read about the work and the results gained on the homepage of the ESR laboratory. We shall give you a couple of examples.



Einar Sagstuen



Eli O. Hole

So far you can see the work carried out by students for their master thesis and PhD. thesis in the historical overview – written in Norwegian. The address is:

http://www.mn.uio.no/fysikk/forskning/grupper/biofysikk/biofysikk_miljofysikk_historikk.pdf

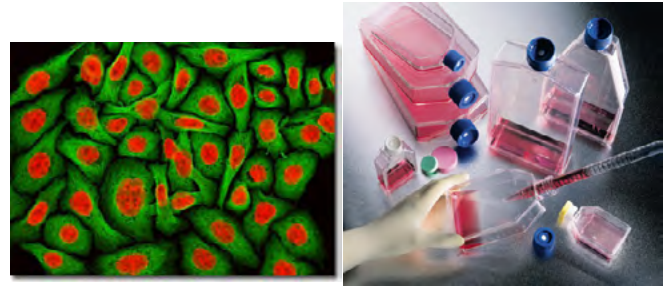

Chapter 12

Cellular radiation damage and repair

The study on radiation effects on biological systems made a significant step forward when it was possible to study human cells cultivated in the laboratory. With a cell culture we have several possibilities for studying basic biological processes.



Wilhelm Roux
(1850 – 1924)

The way towards a cell culture system included a lot of fumbling and unsuccessful attempts. It started with the English physiologist Sydney Ringer that found that salt solutions containing the chlorides of sodium, potassium, calcium and magnesium were suitable for maintaining the beating of an isolated animal heart outside of the body. In 1885 Wilhelm Roux removed a portion of the medullary plate of an embryonic chicken and maintained it in a warm saline solution for several days, establishing the principle of tissue culture.

It was early found that the cells could live for a long time, either in solution, or attached to a glass when the right conditions (such as temperature and growth medium) were present in the cell incubator. The growth rate of animal cells is relatively slow compared with bacteria. Whereas bacteria can double every 30 minutes or so, animal cells require anywhere from 18 to 40 hours to double. This makes the animal culture vulnerable to contamination, as a small number of bacteria would soon outgrow a larger population of animal cells. Then the cells died – and this was a mystery for a long time.

Most cells can be kept alive through a few cell divisions – and then die out. Leonard Hayflick found that the cells are ageing and could only go through a restricted number of divisions (of the order 40 – 60). This puzzle now belongs to the research history due to the work of Elizabeth H. Blackburn, Carol W. Greider and Jack W. Szostak. They found that the chromosomes are protected in the end by “*telomeres*”. A telomere is a region of repetitive DNA sequences (such as TTGGGG) at the end of a chromosome, which protects it from deterioration or from fusion with neighboring chromosomes.



Leonard Hayflick

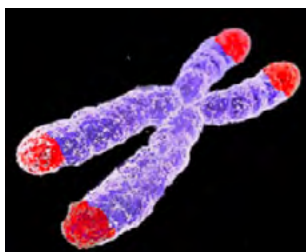

Teleomers are indicated by the red caps on the chromosome ends

Each time the cell divide a piece of the chromosome end is not rebuilt, and the chromosome and cell ages. After a number of cell divisions the cell and the culture dies out – unless the cell can rebuild the telomere. The above scientists found that some cells – in particular cancer cells have an enzyme, “*telomerase*”, that could rebuild their telomeres. Telomerase is a “reverse transcriptase” consisting of a RNA-component and two protein components. The enzyme is usually not present in somatic cells, but is found in embryonal cells, in stem cells and in the sex cells. The activity of telomerase is important for the formation of immortal cell lines. More than 85 % of all cancers have telomerase activity. The three scientists that pointed out the importance of telomeres and telomerase earned the 2009 Nobel prize for this work.



The Nobel Prize in Physiology or Medicine 2009 was awarded jointly to Elizabeth H. Blackburn, Carol W. Greider and Jack W. Szostak

“for the discovery of how chromosomes are protected by telomeres and the enzyme telomerase”.

From left; Jack Szostak, Carol Greider and Liz. Blackburn.

Establishment of the HeLa cells

The major step in the direction of an immortal cell line was taken in 1951. George Gey, head of tissue culture research at John Hopkins Hospital in Baltimore was able to cultivate cells from a cervix cancer of Henrietta Lacks. She died from her cancer, but the cancer itself is still alive with the name HeLa cells.

The HeLa cell line was derived for use in cancer research. These cells proliferate abnormally rapidly, even compared to other cancer cells. In Rebecca Skloot’s *“The Immortal Life of Henrietta Lacks”*, she explains that HeLa cells have an active version of telomerase during cell division, which prevents the shortening of the telomeres. In this way, HeLa cells circumvent the Hayflick Limit, and the cell line could go on forever, It has been estimated that the total number of HeLa cells that have been propagated in cell culture far exceeds the total number of cells that were in Henrietta Lacks’ body.



George O. Gey
(1899 –1970)

Tissue culture technique is the most convenient way of examining cell behavior so far. A small fragment of tissue (a cell, a population of cells, or a part or complete organ) is sustained in a complex biological (tissue extract) or synthetic nutrient medium with appropriate temperature and pH for the cells being developed. The process has multiple applications in visualizing normal and abnormal cell structure, genetic and biochemical reactions, aging and healing processes, metabolism and radiation biology.

Theodore T. Puck and Philip I. Marcus started to study the effects of x-irradiation on HeLa cells in 1956. They studied the survival of single cells (defined as the ability to form a macroscopic colony within 15 days) as a function of radiation dose.

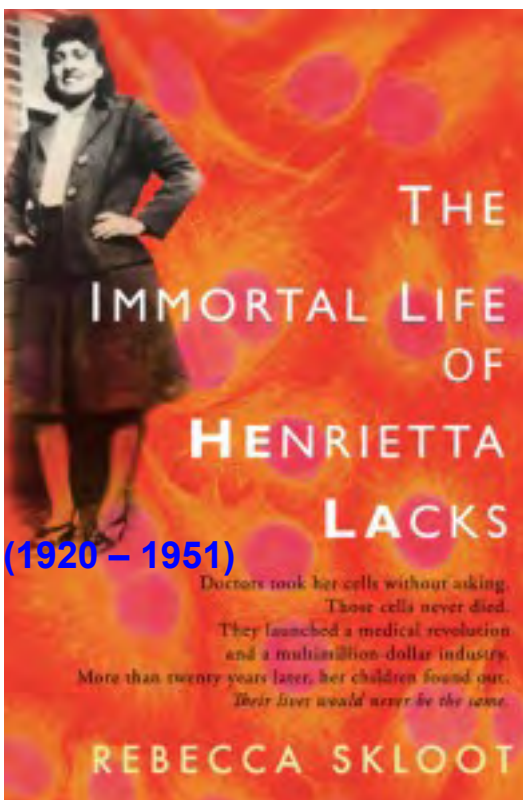

The experiment goes like this:

Cells from a dish is suspended. The cells are then counted and a certain number of cells is seeded and incubated for 1 to 2 weeks. The single cells will divide several times and form colonies that can be seen and counted. The control dish give us the “plating efficiency”. These cells serves as control.

Other cells are given a radiation dose (before seeding). This procedure give the survival curve. See the figure below.



Theodore Puck

Philip Marcus

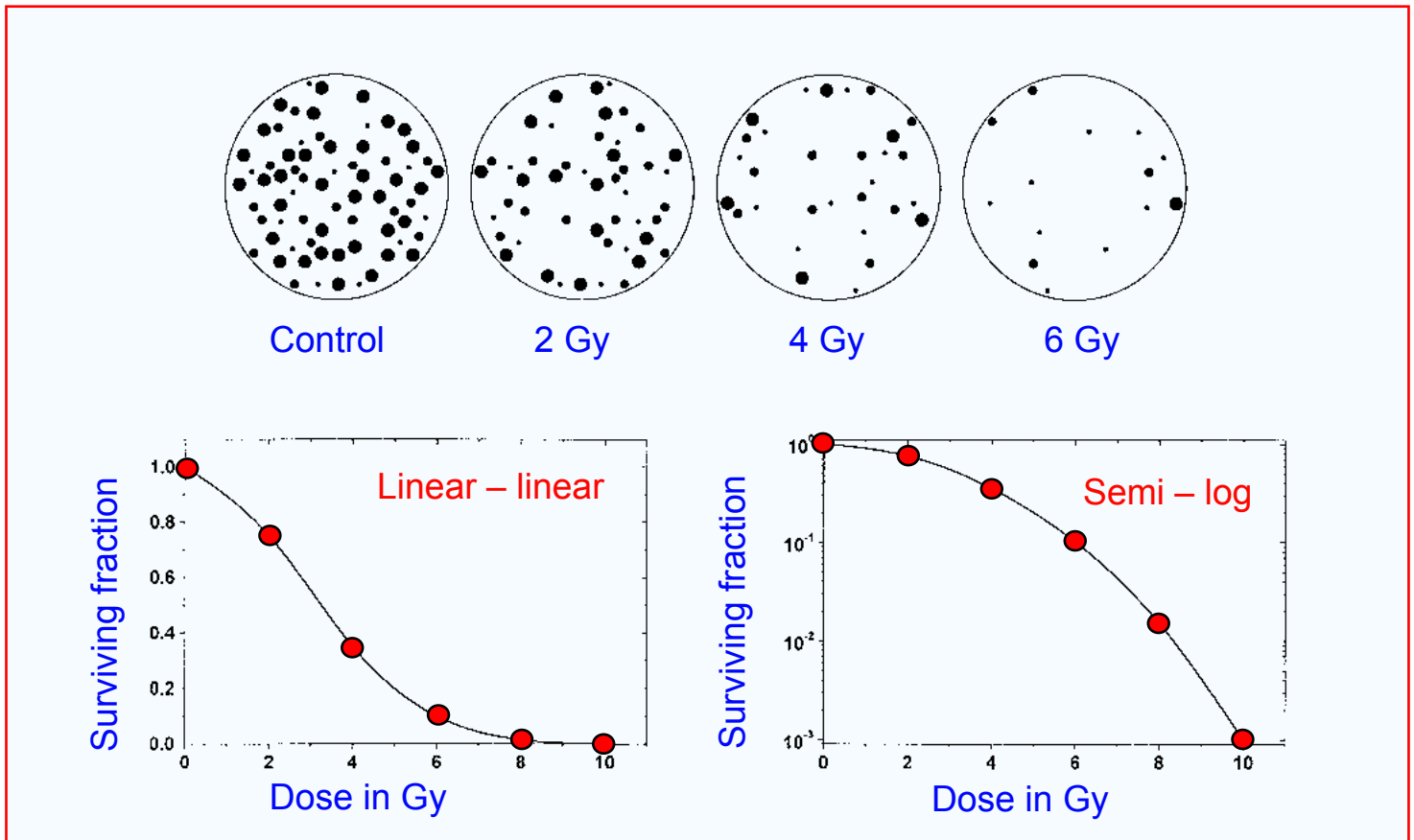

We have plotted the results in two different ways; in a linear – linear plot (both the dose and the surviving fraction are given on a linear scale), and in a semi – log plot. The axis for survival is in a logarithmic scale.

The mathematical expression that gives the best correlation to the experiments is the so-called linear-quadratic curve.

$$S = e^{-\alpha D - \beta D^2}$$

S is the surviving fraction, D is the dose and α and β are constants.

If the radiation is continued to seven and more decades the curve will be more and more linear in the semilog plot.

The cell culture technique gives us opportunities to study the different factors within radiation biology such as the effect of LET (different types of radiation), the oxygen effect, the radiosensitivity through the cell cycle and repair processes. *Some of the basic mechanisms within radiation biology can be studied using cell culture.*

Examples of properties that can be studied

In the following a couple of examples are given which give information about the effect of radiation on living cells.

LET dependence

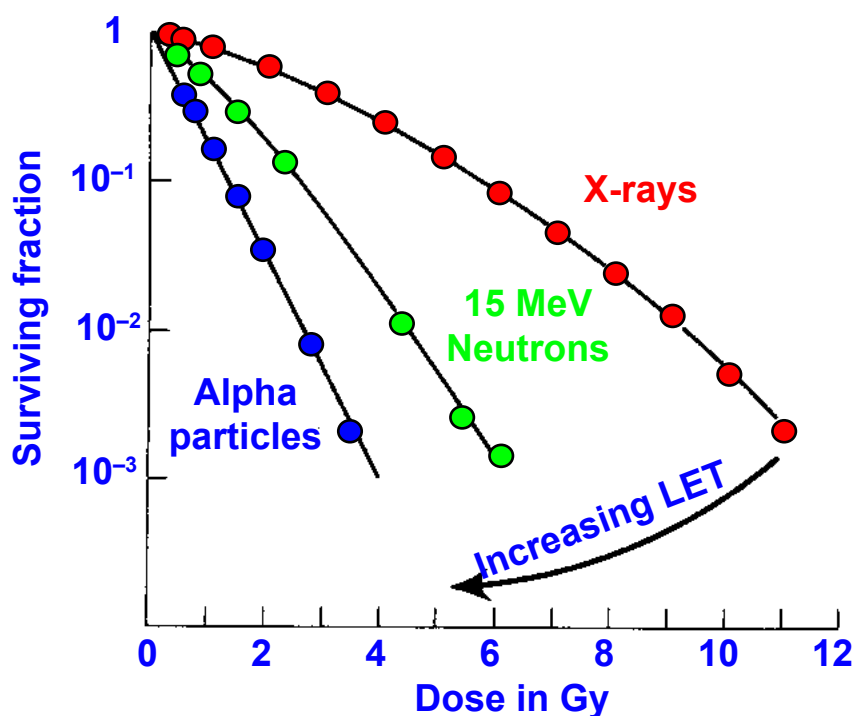

In the figure are given some old results which show the effect of increasing LET on the survival curves. With increasing LET the curves becomes steeper and the shoulder seems to disappear.

Steeper survival curves show that the “relative biological effect” (RBE) increases.

The LET for x-rays is about 2 keV/ μm and increases to about 150 keV/ μm for α -particles. The LET values that leads to highest kill is approximately 100 keV/ μm . With this LET, the relative biological effectiveness may be 4 – 8 times higher than for megavoltage photon radiation. Data like this are very interesting for the discussion we had in connection to the effect of the radiation from radon daughters (see page 112).

The oxygen effect

Another research field that is important – particularly within radiation therapy – is what we call the oxygen effect. The early observations (some results are given below) showed that the cells are killed more easily in the presence of oxygen, compared to where the oxygen level is reduced (hypoxic cells). Since solid cancers generally contain areas with abnormally low levels of oxygen, it appears that cancer cells in such hypoxic micro-environments are resistant to treatment.

Recent research has furthermore shown that hypoxia in tumors is one of the major drivers of metastatic spread of cancer, the major cause of death by the disease. Thus, hypoxia is responsible for a double effect of reducing the potential of a successful treatment of the cancer patient: Resistance to treatment and ability to spread. At the same time the very low level of oxygen found in solid tumors are specific to cancer.

Therefore, if one could develop methods that specifically located and inactivated cells in hypoxic areas one might obtain a cancer-specific effect, selective for the most harmful of the cancer cells. This development is the core task of the METOXIA project which is a cornerstone in the biophysics group at the University of Oslo. We shall return to this research, but first we give some of the early results using cell culture.

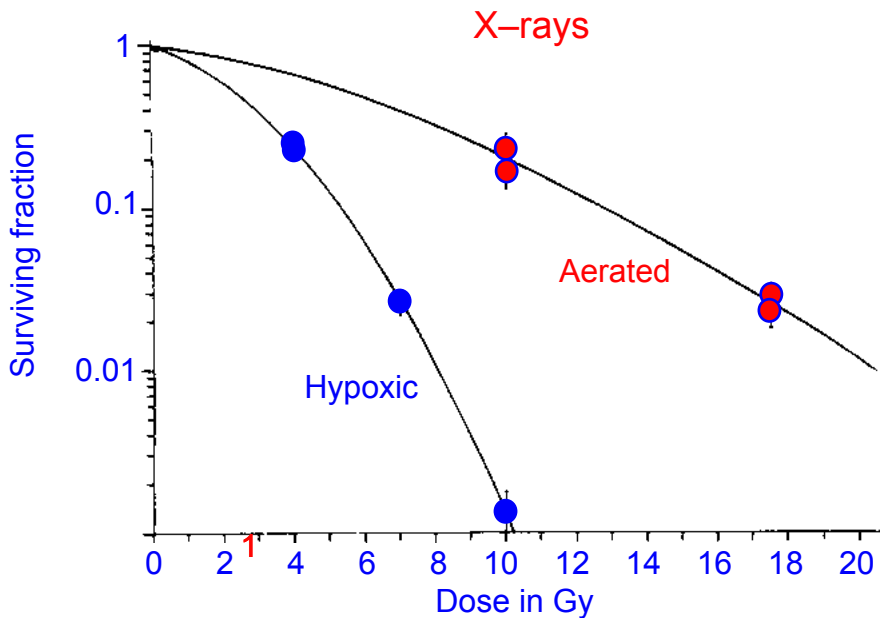

From figures like the one to the left it can be calculated that the “**Oxygen Enhancement Ratio**” (OER) is about 2.5.

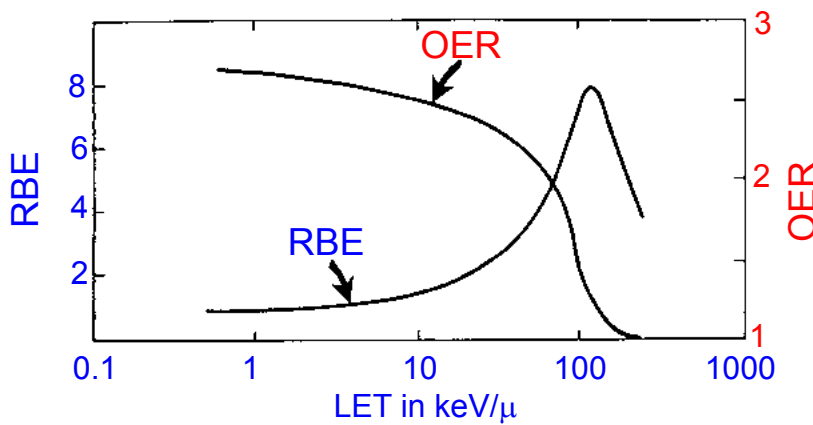

If we use other types of radiation like neutrons (15 MeV energy) the OER drops to 1.6. For α -particles with energies in the range 2 – 4 MeV, OER approaches 1.0. If we put the two parameters, OER and RBE, together we obtain the figure to the left.

Radiation damage and repair

We have excellent opportunities with cell cultures to study radiation mechanisms and repair processes. A tissue culture laboratory is also quite central within cancer research.

The cells usually grow asynchronously, that is the cells are in different phases of the cell cycle. Experiments with beams of particles can be directed to different parts of a cell. They demonstrate that the nucleus is more radiation sensitive than the cytoplasm. When asynchronous cell cultures are irradiated with a dose of 5 Gy a decrease in mitosis is observed (mitosis is the division of the cells, and consists of the phases: prophase, metaphase, anaphase and telephase). The fraction of cells which are in mitosis (“the mitotic index”) will decrease. This means that the growth in the number of cells has slowed. After a few hours the mitotic index will again increase, reach a maximum, and then decrease, as the synchronized cell population goes through cell cycle.

Cell death induced by radiation can be divided into two groups:

1. If a cell dies after the first mitosis it is called **mitotic death or reproductive death**.
2. If the cell dies before reaching the first mitosis it is called **interphase death**.

Cells which survive large doses very often have chromosome abnormalities.

The cell cycle

A living cell goes through several stages from the moment it is “born” by cell division until it divides, forming two new cells. Before division takes place the cell content of DNA must double. This cell cycle can be divided into 4 stages (see figure) and the radiation sensitivity differs for each stage.

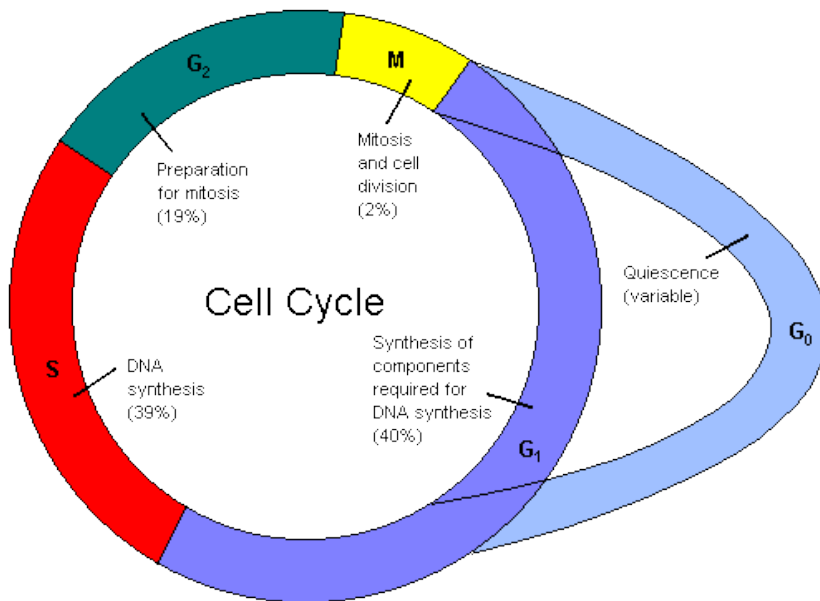

The cell cycle can be visualized in many different ways – and the illustration to the left is one of them.

During the cell cycle, the first phase includes the creation of enzymes required for DNA synthesis (G_1 phase). The second phase includes the actual DNA synthesis and chromosomal replication (S phase). Protein and RNA synthesis occurs in the next phase (G_2 phase). The last phase is mitosis or cell division (M phase). After this, a cell may either go into the resting phase (G_0 phase) or straight back into the G_1 phase. The cell cycle is regulated by the genes within the cell, signalling molecules, and monitoring biochemical molecules.

Repair Processes

In 1959 M.M. Elkind and Harriet Sutton at the National Institutes of Health published a paper which demonstrated cellular repair processes. Today it seems obvious that living cells must have a repair system since damage occur to DNA all the time, mainly from the life processes in the cell (*endogenous damage*), but also from external sources such as ionizing radiation, UV, and a number of chemical compounds (*exogenous damage*).

Since Elkind and Sutton presented the first experiments we shall look in more detail into the experiment. They carried out cell culture work and irradiated Chinese Hamster cells. They obtained survival curves like that in the figure (next page) by red points.

In the next experiment they split up a dose of 10 Gy into two equal doses of 5 Gy with an interval between the exposures. In the interval the cells were incubated at 37 °C. The survival after two 5 Gy doses increased with the time elapsed between the two irradiations. This is given in the figure (next page) by blue points.

Elkind and Sutton interpreted the results in the following way; the first dose of 5 Gy killed a number of cells whereas other cells attained damage that they called “*sublethal damage*”. In the time interval between the two doses the damage could be repaired and the cells were “healthier” when the next dose hit.

This can be compared to a boxing match where one of the boxers sustains a number of hits, but is saved by the bell. Between rounds the crew works in order to get the boxer fit to continue the fight.

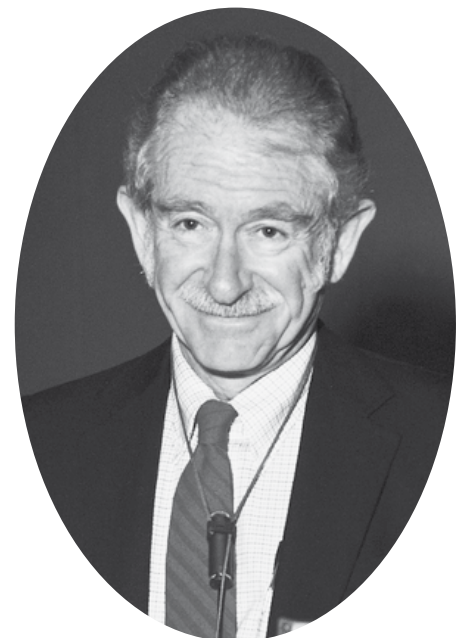

Mortimer M. Elkind
(1922 – 2000)

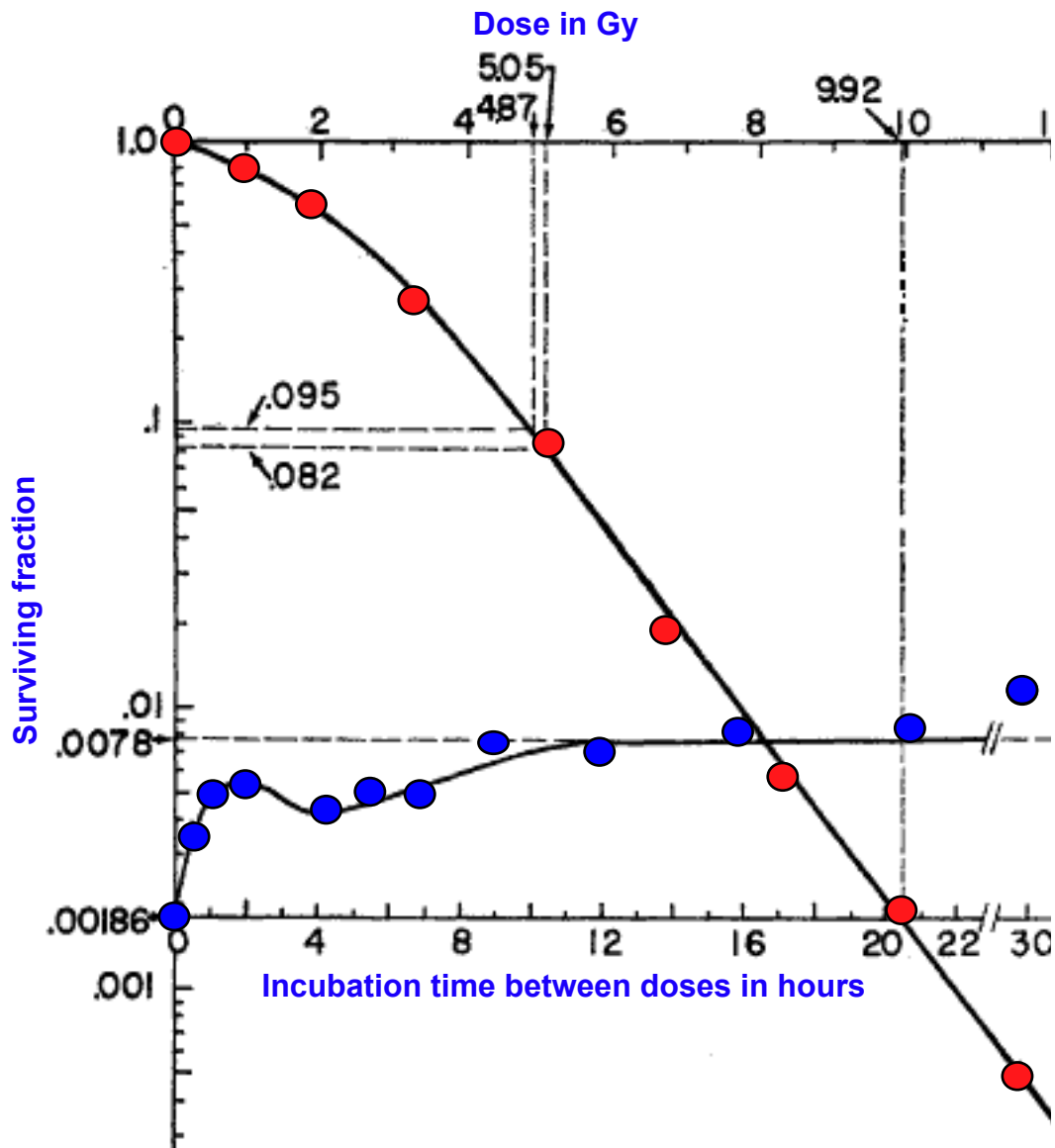

The above figure is from the work of Elkind and Sutton published in *Nature*, Vol 184, 1293 (1959). They used Chinese hamster cells. The ordinary survival curve is given by red points (note that the dose axis in Gy is given on top). The split dose experiment (two doses of 5 Gy with a time interval between the irradiations) is given by the blue points as a function of the time between the irradiations. The time axis in hours is given on the bottom.

It is clear that the cells have repair systems. This is a necessity for survival. The crew working on repair in our cells are enzymes. It is the job of some enzymes to detect DNA damage while others are called upon to repair the damage. The repair processes can be divided into three types:

- The specific site of damage is repaired. In this case the enzymes work right at the damaged site. The original base sequence is preserved.
- The whole stretch of DNA containing a damaged site (or sites) is removed and replaced, preserving the native sequence.
- The damage is ignored during replication; it is by-passed. With luck the correct base will be inserted or, if incorrect, it won't matter. Because this type of repair is error prone, it is held in reserve in case the higher fidelity repair systems miss, or cannot cope with, the damage. For this reason, it is aptly called "SOS" repair.

Excision repair

One important repair mechanism is “*excision repair*”. This repair mechanism involves enzymes that cut out the damaged part of DNA and replaces it with a new undamaged part.

One of the scientists working on understanding repair processes was Gunnar Ahnstrøm at the University of Stockholm. His imaginative drawing showing the essential elements of DNA repair is given in the figure below.

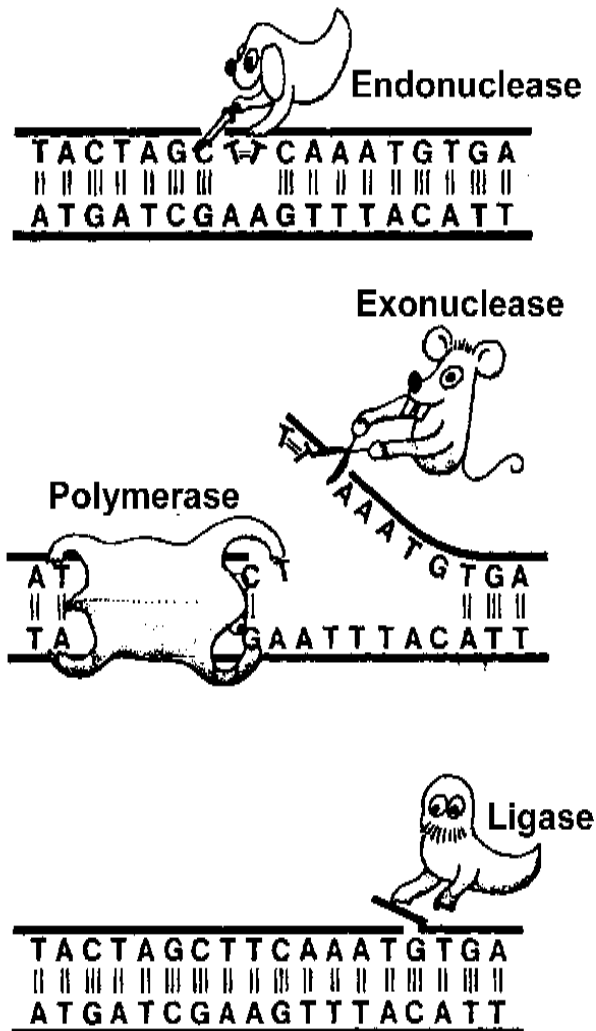

Gunnar Ahnstrøm
(1929 – 2008)

In the figure Gunnar Ahnstrøm has outlined the steps in this repair mechanism. The process includes altogether four enzyme groups. If you look into the details you will find that Prof. Ahnstrøm has included an error in base pairing. Can you find it?

Courtesy of Gunnar Ahnstrøm

The excision repair mechanism includes the following steps:

- 1. Recognition.** It is important to have enzymes that can recognize the damage and signal for help.
- 2. Cutting of the DNA-strand.** It is a requirement that specific enzymes, like the endonucleases, can cut the DNA-strand in the neighborhood of the damage.
- 3. The damaged part is removed and rebuilt.** Exonuclease and polymerase are key enzymes. The former cuts out the damaged part and polymerase replaces it with a new undamaged part.
- 4. Joining.** The repair is finished when the ligase enzyme joins the cut DNA-strand back together.

The repair system, outlined above, is found in humans and microorganisms. An array of repair mechanisms are used to repair not only radiation-induced damage but also damage stemming from a multitude of other agents, including the routine damage that occurs as part of normal cell function. A repaired cell divides and functions in a normal fashion.

What happens when the repair system fails or is too weak ?

When we are out in the sun and exposed to UV light, adjacent pyrimidine bases (C or T) become fused together and pyrimidine dimers are formed in the skin cells. Normally, our repair mechanisms are intact and can repair the extra damages from the UV-radiation. However, there is a genetic ailment for which the above described repair system is too weak to repair all of the extra damage caused by the sun. The ailment is called *Xeroderma Pigmentosum*. It has been found that the enzyme endonuclease is weak and often fails to do its job. The result is that people with this genetic defect have a high risk for developing skin cancers that are often lethal.

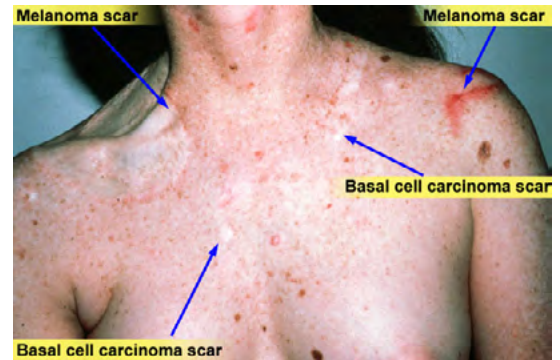

An example of *Xeroderma Pigmentosum*

DNA-damage and defense mechanisms

On page 243 we presented an illustration which showed the many ways for damage to the DNA-molecule. It was pointed out that the DNA-damage may be caused by both endogenous as well as exogenous processes. The endogenous damage is mainly caused by reactive oxygen radicals (called ROS) – whereas the exogenous damage come from different sources including ionizing radiation, UV and chemical substances.

Reactive oxygen species

ROS are produced by the oxygen metabolism. Most of the molecular oxygen is converted into CO_2 whereas a small fraction (about 5 %) is converted into reactive oxygen species. Enzymes and free radical scavengers mainly take care of this endogenous production of ROS. However, some damage is caused in DNA, proteins, lipids, and carbohydrates.

It is assumed that about 50 000 single strand breaks and 8 double strand breaks are produced each day in each cell by ROS. This amount of damage is approximately equivalent to that caused by a daily radiation dose of 200 mGy (or about 8.3 mGy/hour)! (The interested reader can compare this with the dose levels around Chernobyl and Fukushima; page 99).

A pool of DNA-damaged cells

The number of DNA-damage from endogenous and exogenous mechanisms is very large – and we have a pool of damaged cells. As long as these cells are in the resting phase G_0 the situation is under control. However, when damaged cells go into the cell cycle it is important to have a system to handle the damage. It is assumed that the initial step in cancer development is a damaged cell which is promoted into the cell cycle. If the cell passes all the control mechanisms a cancer may develop. Consequently, it is quite clear that life would be impossible without defense mechanisms. The two main routes are:

1. Repair mechanisms. We have previously outlined excision repair as an important DNA-repair mechanism, and will not go into more details.

2. Cell death. The other possibility is to kill the damaged cell. (*A dead cell can never give cancer*). It appears that the cells have a mechanism called “*apoptosis*” or “*programmed cell death*” that can be triggered with the result that the damaged cell is killed whereas the organism survive.

Apoptosis

Apoptosis is a cellular defense system that kill the damaged cell. It consists of a cascade of events which lead to the destruction of the damaged cell – as visualized in the diagram below.

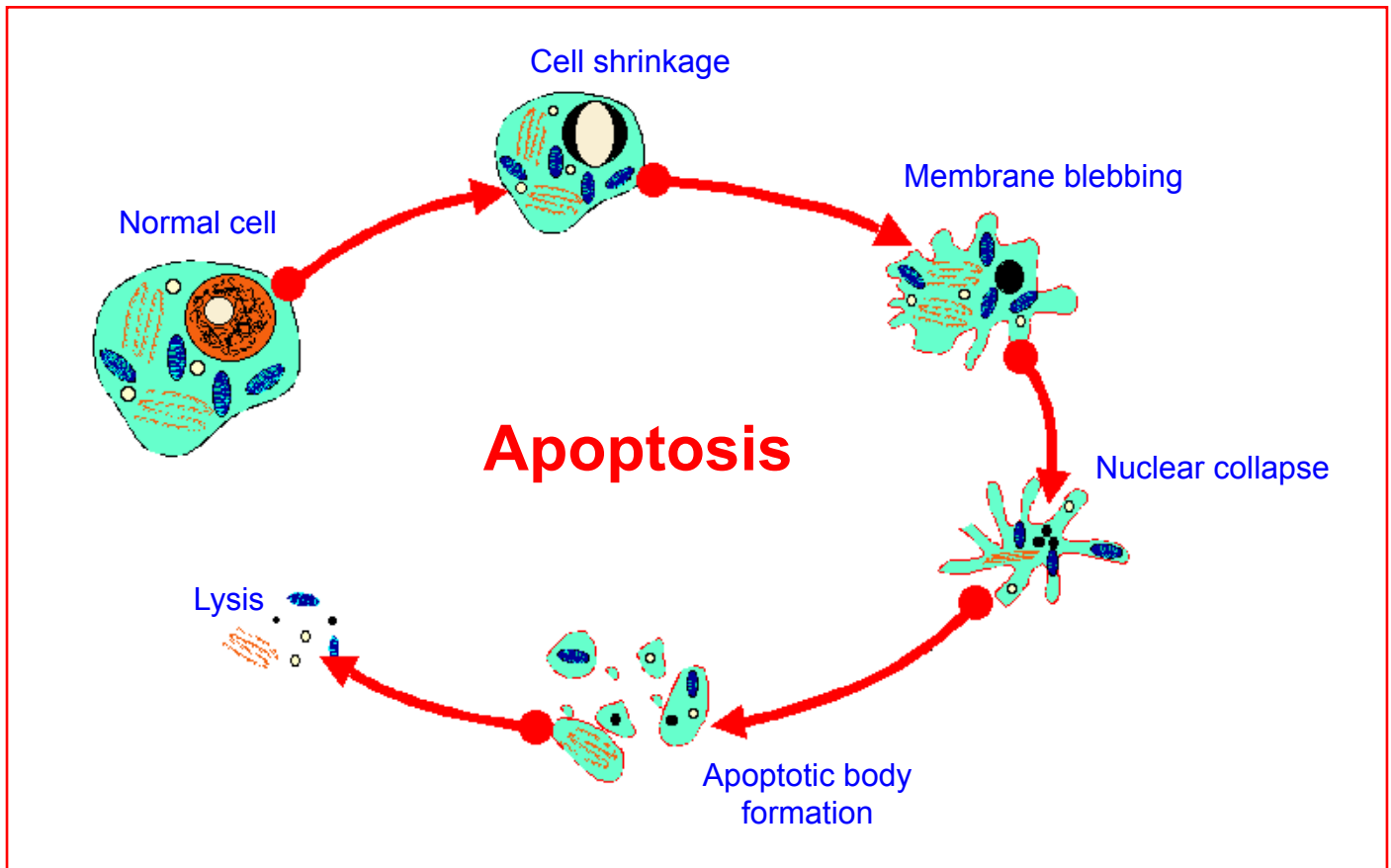

Apoptosis was described more than 100 years ago. However, it was not until 1965 that John Foxton Ross Kerr at University of Queensland discovered what he called “*shrinkage necrosis*”.

This discovery resulted in an invitation for Kerr to join Alastair R Currie and Andrew Wyllie at the University of Aberdeen.

In 1972, the three published the famous article in the British Journal of Cancer.

“Apoptosis: A Basic Biological Phenomenon with Wide-ranging Implications in Tissue Kinetics”



Andrew Wyllie



John F. R. Kerr

In the final stage of apoptosis the cell debris is engulfed by white blood cells (see illustration).

Apoptosis, or programmed cell death, is important during development of the embryo, but is also acting to destroy cells that represent a threat to the integrity of the organism. Between 50 and 70 billion cells die each day due to apoptosis in the average human adult.

A wide variety of stimuli are capable of triggering apoptosis. Some are universal and can produce apoptosis in almost any cell. The signals usually consist of proteins that serve to protect the organism from cancer by killing cells with DNA-damage that cannot be repaired.

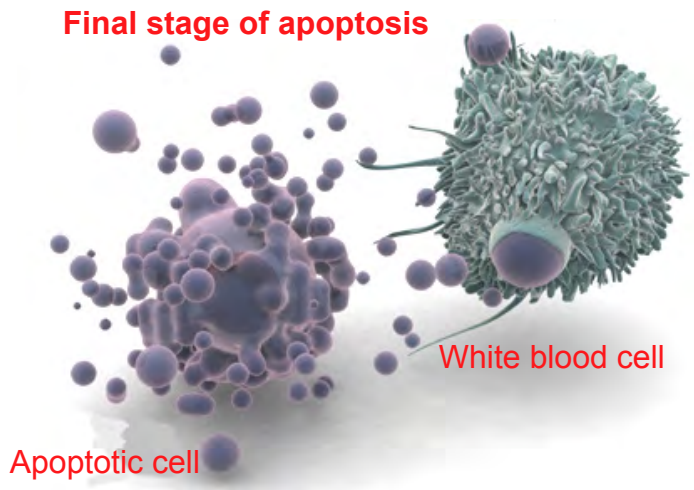

The cell is stopped in the cell cycle at certain checkpoints and proteins like p53 start the apoptotic processes.

Here we embark into an active research field with a number of extremely interesting data. We are not able to go into this research – but would like to give some glimpses of the exiting field.

Cell cycle checkpoints

In the normal cell cycle we find a number of checkpoints through the cycle. The point is that if DNA-damage is present the cell cycle is stopped and time is given to repair. If repair is not the best – cell death such as apoptosis may be triggered.

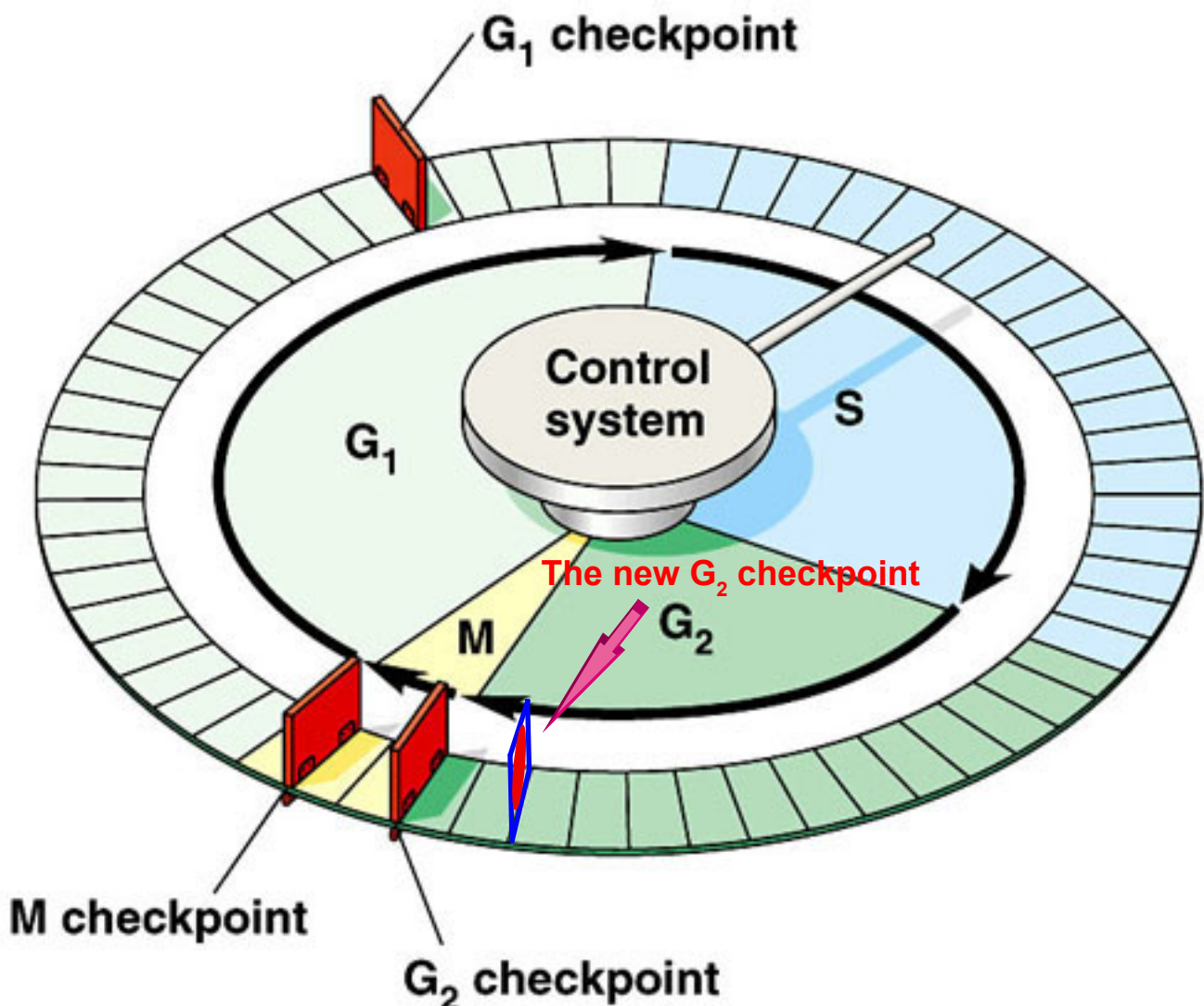

We have a G_1 and a G_2 checkpoint as well as checkpoints both in the S-phase and in mitosis. Recently, we have learned that radiation may induce checkpoints.

The cell cycle checkpoints are made up of composites of protein kinases and adaptor proteins which all play important roles in the maintenance of the integrity of the division.

All the checkpoints examined require the services of a complex of proteins. Consequently, mutations in the genes encoding these proteins have been associated with cancer; that is, they are oncogenes. This should not be surprising since checkpoint failures allow the cell to continue dividing despite the DNA-damage. We shall return to the newly detected G_2 checkpoint.

One of the proteins engaged should be mentioned in some more detail – namely the protein called p53 and the gene that encodes this protein. The protein is very important and connected to the checkpoints.

p53

The p53 protein was discovered in 1979 by David Lane in England and Arnold Levine in USA. From the beginning it was considered to be very important – and was in 1993 selected as “*molecule of the year*”.

The name of the protein is from its molecular weight of approximately 53 kdalton (due to the high number of proline residues the molecular weight may be smaller).

In humans, p53 is 393 amino acids long and is encoded by the TP53 gene located on the short arm of chromosome 17.



Sir David Lane
(1952)



Arnold Levine
(1939)

The molecule p53 is important in multicellular organisms, where it regulates the cell cycle. It has been described as “the guardian of the genome”, and the “master watchman”. The molecule works through several mechanisms:

1. It can activate DNA repair proteins.
2. It can induce growth arrest by holding the cell cycle at the G_1/S checkpoint and give the cell time for the DNA repair proteins to fix the damage.
3. It can initiate apoptosis, if DNA damage proves to be irreparable.

The p53 protein is a key player in apoptosis, forcing “bad” cells to commit suicide.

In normal cells, the p53 protein level is low. However, DNA damage and other stress signals may lead to an increase of p53 proteins. The p53 proteins stop the progression of the cell cycle and activate the transcription of proteins involved in DNA repair. If repair is not the best choice, apoptosis is the “last resort” to avoid proliferation of cells containing abnormal DNA.

As you can see from this, cells with a mutant type of protein p53 may develop into a cancer cell. In fact it has been found that **more than half of all human cancers do harbour p53 gene mutations** and consequently have no functioning p53 protein.

In this discussion it is important to mention that radiation activates the formation of p53. Thus, the defense mechanisms do not follow the LNT-model. Their nature and level of activation depend on dose and dose-rate.

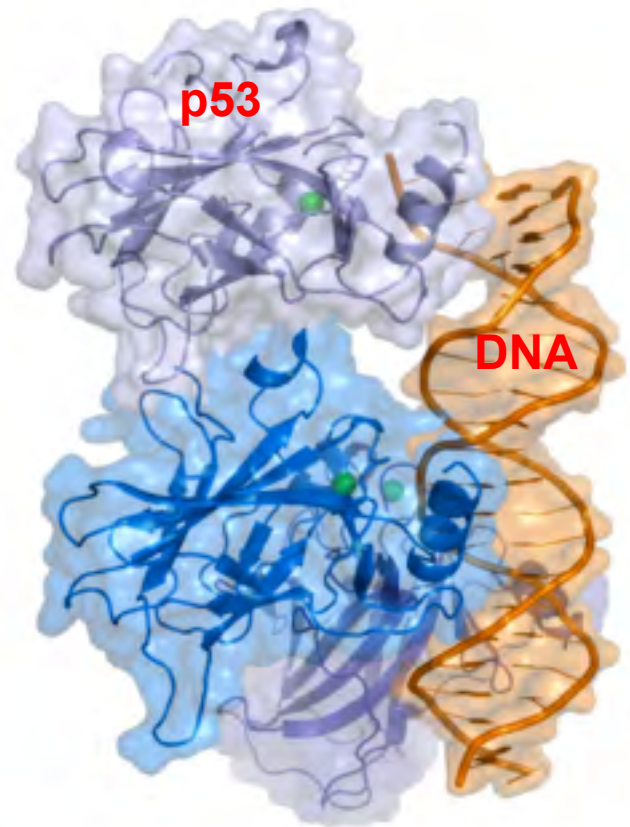
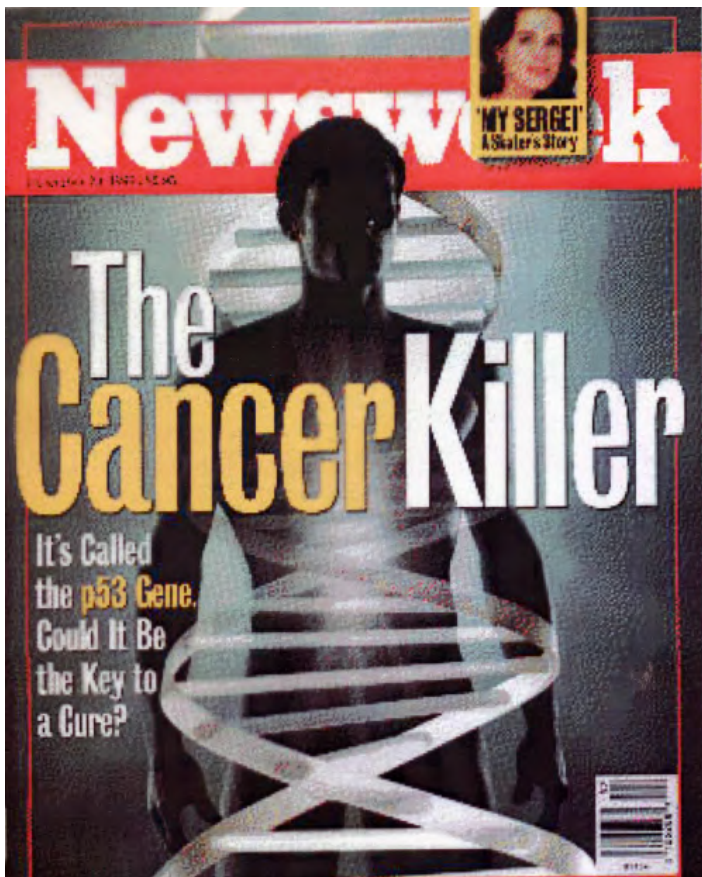

The above frontpage in Newsweek was presented in connection to the announcement in Science of p53 as “**Molecule of the year**”. Below we give some of the arguments for this choice.

Some molecules are good guys, some are bad guys, and some become bad because they fail in their functions. The molecule p53 is a good guy when it is functioning correctly. It is a tumor suppressor in that it halts abnormal growth in normal cells and thus prevents cancer. Therefore, we have chosen p53 as Molecule of the Year for 1993.

About 50 percent of all human cancers contain a mutation in p53, so hopes are high that the molecule will provide new insights into treating the disease. Curing cancer and curing a bacterial disease are very different problems. The p53 protein is part of a fundamental pathway in human cell growth, and finding p53's function allows scientists to develop strategies for the diagnosis, prevention, and cure of cancers resulting from p53 deficiencies.

The p53 protein is also identified with a process of programmed cell death that may be important in killing cancer cells, and further understanding of this process provides hope for cancer therapy. Thus, p53 and its fellow tumor suppressors are generating an excitement that suggests prevention now and hope for a cure of a terrible killer in the not-too-distant future. In this endeavor the 1993 “Molecule of the Year” is certain to play a major role.

Tumor suppressor genes

The gene for p53 is called a “**tumor suppressor gene**” since the gene reduces the probability that a cell in a multicellular organism will turn into a tumor cell. It is easy to understand that a mutation in such a gene may increase the probability of tumor formation.

Even though, p53 has got a lot of attention, we have in recent years found a number of other tumor suppression genes. They are connected to different types of cancer. It is important that these genes are working – since damage to them increase the risk for cancer.

Adaptive Response

Research with living cells have demonstrated that cellular resistance to radiation damage can be increased by small stimulating doses. The radiation community has named it “*adaptive response*”.

Experiments exhibiting adaptive response started in 1984 with the work on human lymphocytes by G. Olivieri, J. Bodycote and S. Wolff at University of California.

The lymphocytes were cultured with ^3H -labeled thymidine that was incorporated directly in the DNA-molecule and served as a source of low-level chronic radiation. Tritium (H-3) is radioactive with a half-life of 12.3 years. It emits a β -particle with maximum energy of 18.6 keV. The cells were then irradiated with x-rays to a dose of 1.5 Gy and the yield of chromosome aberrations recorded.

It was found that the number of chromosome aberrations was *fewer* after exposure to *both* sources (tritium β -particles as well as x-rays) than after x-rays alone. These results showed that low levels of radiation can trigger or induce increased repair of radiation induced chromosome breaks.

Throughout the 1990s a large number of experiments were published on different systems that demonstrate an adaptive response. A number of end points have been studied such as cell killing, micronucleus formation, induction of chromosome aberrations, induction of mutations and neoplastic transformations. The adaptive response has been detected when cells have been exposed to a small dose (10 -100 mGy) and then challenged with a much higher dose. Let us briefly mention a few points:

- The amount of chromosome damage in lymphocytes can be reduced by up to 50% if a dose of 10 to 150 mGy is given to the cells before a larger dose of 1.5 Gy is given.
- In order to attain a maximal effect, the stimulating dose must be given 4 to 6 hours ahead of the large dose. The effect seems to last through a couple of cell cycles.
- Adaptive response has also been found in the case of mutations in the fruit fly (*drosophila melanogaster*). The number of mutations was reduced when a small dose of 200 mGy was given before a large dose of 4 Gy.

In this study with adaptive response a small dose was given before a larger challenge dose was used. The interesting result that a small so-called “*priming dose*” largely influence the effect of the challenge dose has later been used in a number of studies and have given a number of interesting results that largely influences our view of the risk analyses of ionizing radiation.

Before we conclude and embark on the relation between radiation and cancer we would present some recent work carried out. The work clearly demonstrate the radiation itself can stimulate and enhance the cellular defense mechanisms.



Sheldon Wolff
(1929 – 2008)

Some recent research in biophysics at UiO

In the group for biophysics and medical physics at the University of Oslo, experiments are carried out which have a rather strong connection to the field discussed above. Let us therefore try to convey some of the ideas and results here. Those more interested should consult the original work.

Erik Pettersen is in charge of the experiments and Nina Jeppesen Edin is an important coworker. Joe Sandvik as well as a number of students are connected to this group.

The group is working with different types of cells cultivated in the laboratory. In the figure below T-47D cells (human breast cancer cells), have been irradiated with Co-60 γ -rays and the survival curves have been observed.

If the irradiation takes place at a dose-rate of 40 Gy per hour (or 0.67 Gy per minute) the curve in the figure is obtained. This very high dose-rate implied exposure times of less than a minute for the smallest doses in the figure.

The resulting survival curve showed an unexpected form that deviates from the normal linear - quadratic form (stippled curve). A rapid decay is observed at low doses – demonstrating what is known as “*low dose hypersensitivity*” (HRS). The rapid decay in survival is followed by a region with increased radioresistance. At about 2 Gy the survival curve follows the usual linear-quadratic form.

The form of the survival curve depends on the dose-rate. This suggests that the cells may be in two different forms; either in a high radiosensitive form – or in a more protected form.

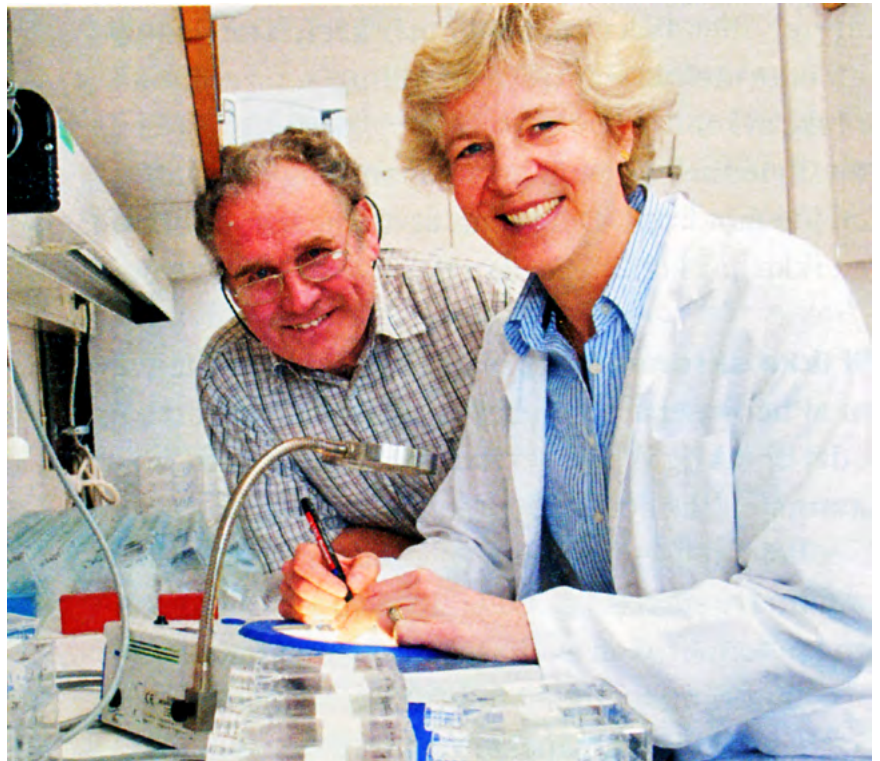

Erik Pettersen and Nina Jeppesen Edin in the tissue culture laboratory

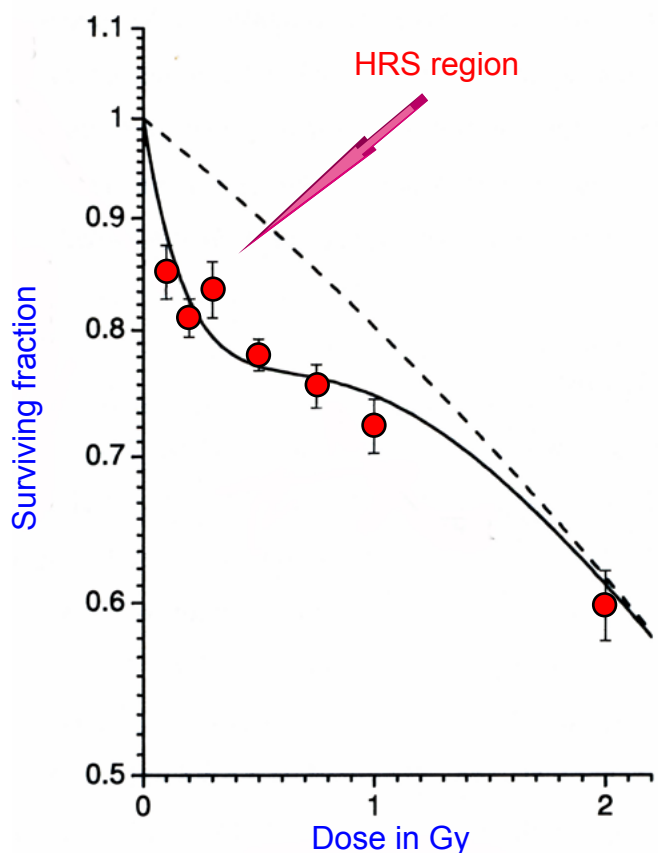

In this figure is given the results of Co-60 γ -radiation on asynchronous T-47D cells. The dose-rate was 40 Gy/h (0.66 Gy per minute).

The dip in the survival curve called HRS (“*low dose hypersensitivity*”) was discovered in 1993 by Brian Marples and Michael Joiner for Chinese hamster cells. It is also called the “joiner dip”.

It can be noticed that for about 80 % of all human cell lines the survival curves display hyper-radiosensitivity (HRS).

HRS has been shown to be connected to a failure to induce the early G₂ arrest that gives time for repair of DNA-damage before entering mitosis.



Brian Marples



Michael Joiner

The new G₂ checkpoint

On page 256 we outlined the cell cycle including the checkpoints. Both G₁ – S and G₂ – M phase transitions are under constant observations in order to protect the cells from both exogenous and endogenous DNA-damaging agents. The checkpoints are controlled by enzymes.

In 2002 Bo Xu and coworkers discovered a new checkpoint in the G₂ phase of the cell cycle that explained the mechanisms for the low dose hypersensitivity.

This checkpoint, which comes in addition to the usual checkpoint (also called “Sinclair” checkpoint), is activated shortly after irradiation. Cells that were in G₂-phase at the time of irradiation are arrested. It can be noted that the new G₂-checkpoint is dependent on the protein kinase ATM (Ataxia telangiectasia mutated).

The ATM-molecule is large, consisting of about 3000 amino acids. It is held inactive in unirradiated cells as a dimer or higher-order multimer. Cellular irradiation causes dimer dissociation and initiates cellular ATM kinase activity which seems to be an initiating event in cellular responses.



Bo Xu

The new G₂-checkpoint is only activated after a certain amount of ATM has been activated. The threshold dose for activating the G₂ checkpoint depends somewhat on the cell line, but it seems to be above 0,2 Gy. Cells receiving doses below this level will not be arrested, but enter mitosis with unrepaired damage resulting in mitotic death or apoptosis.

Priming doses

In line with the experiments showing adaptive effect, experiments were carried out with priming doses; i.e. a small dose is given some time before the larger challenge dose. The Oslo-group used a priming dose of 0.3 Gy. This dose is not very low, but it had a significant effect. Thus, if the “*priming dose*” was given 6 hours ahead of the challenge dose the HRS could not be observed.

The effect depends on the doserate used for priming. Thus, for a doserate of 40 Gy/h the effect lasted for about 24 hours, however, for a doserate of 0.3 Gy/h the abolition of the HRS seems to last forever (so far it has been observed for 5 years).

Surprising experiments

Experiments were then carried out with cells given a priming dose – both at a high doserate (40 Gy/h) and at a low doserate (0.3 Gy/h). Then the medium from these cells was harvested and transferred to unirradiated T-47D cells. Then the challenge dose was given.

It appeared that the medium from high dose rate priming had no effect on HRS (the low dose hypersensitivity) – but the medium from the low dose rate priming not only removed the HRS, but the recipient cells that received small doses of challenge irradiation had a higher surviving fraction than the control recipient cells.

These results indicate that low dose rate irradiation induced a factor (a protein) to the medium that made the cells more resistant for later radiation.

The Oslo-group have also found that this factor is formed by irradiation of living mice. When serum from these mice are added to the cells and irradiation experiments are performed the cells show no HRS – they are transformed to the radioresistant phase.

The mechanism

The Oslo group have suggested the following mechanism for transforming cells from HRS to a more radioresistant form and vice versa.

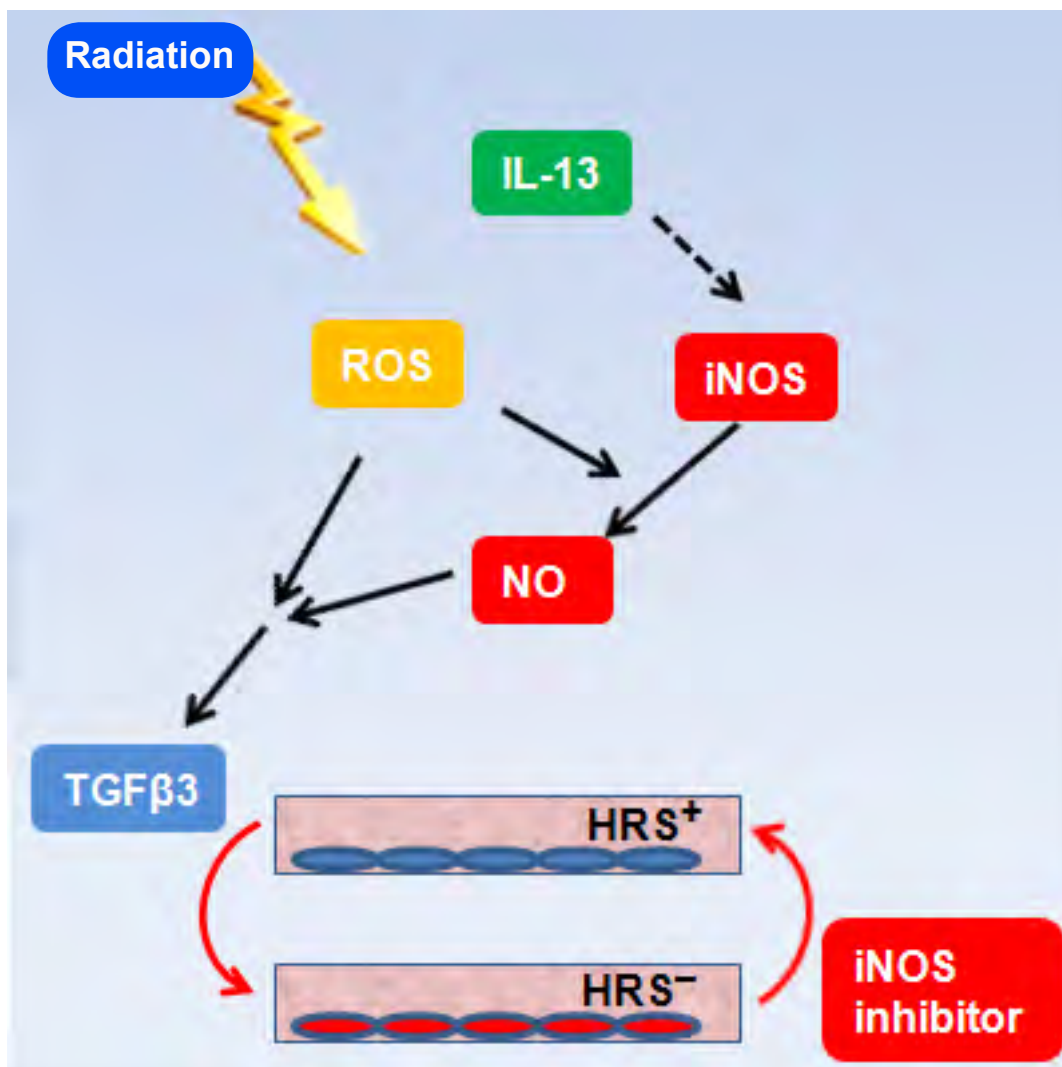

In this figure **HRS⁺** implies cells that exhibit high radiation sensitivity and **HRS⁻** indicates cells that lack this behavior – that is they are more radioresistant.

The figure indicate that you can go from one side to the other. In the first place you can remove HRS by the factor TGFβ3 – and you can go the other way by iNOS inhibitor.

The TGFβ3 factor is induced by radiation and is formed by priming doses or can be added to the cells from previously irradiated medium or by serum for irradiated mice.

Explanations to the model

TGF β 3 is the short name for “Transforming growth factor β -3”. It is a type of protein, known as a cytokine, which is involved in cell differentiation, embryogenesis and development. The figure above indicate that the factor is formed by radiation via ROS (reactive oxygen species – radicals such as hydroxyl OH, superoxide anion O₂⁻ and others). TGF β 3 is only stabilized in an active form via the NO-radical. The NO radical can be synthesized on demand for short periods of time (seconds to minutes) following enzyme activation. NOS (Nitric oxide synthetases) are a family of enzymes that catalyse the production of nitric oxide (NO) from L-arginine.

An important question is whether radioresistant cells can be transferred to a more sensitive stage? The figure above indicates this possibility may occur using compounds that inhibit the iNOS. This latter possibility may be important in cancer radiation therapy. In the central parts of all solid tumors we find hypoxic cells and these cells have also induced TGF β 3. It would be very important if we could transform these cells into a HRS stage.

Summing up

The model outlined above may have significant importance in cancer research. In the first place the model suggests that a small radiation dose given with a small doserate enhance the defense mechanisms. Thus cells with DNA-damage is stopped at the new G₂ checkpoint and given time for repair or directed into apoptose.

The model also indicate that it is possible to go the other way and force hypoxic cells or cells with previous history of radiation into a more radiosensitive stage.

Conclusions of the chapter

The work with tissue cultures has given a lot of information about the cellular mechanisms and how the cells can cope with errors and damage. We have learned a lot about the mechanisms going on in the cell cycle and that several checkpoints must be passed. The checkpoints are guarded by enzymes and the genes for these enzymes should be free from errors. This is very important in cancer biology. We have seen this in the case of the skin cancer Xeroderma pigmentosum (see page 254). Similar situations are met in the case of leukemia and lymphoma, breast and ovarian cancers, colon cancers and brain tumors.

We can sum up some of the important findings in the following way:

- 1.** The cells have repair systems. Important to the repair system are the enzymes that guard the cellular checkpoints and carry out the repair.
- 2.** The cells have a programmed death system (apoptosis), that can take out and kill the most damaged cells.
- 3.** Adaptive response. It has been observed that small doses of radiation given before a large challenge dose prepare or trig the repair processes with the result that the radiation damage is reduced.
- 4.** The Oslo group has found that small radiation doses, given at a low doserate, release the TGF β 3 factor that is important with regard to the repair processes. Radiation seems to be a necessity for life!
- 5.** The cell research experiments give a contineous stream of data which show that the results are influenced by small doses given at a low doserate. For the future we can expect more interesting data.

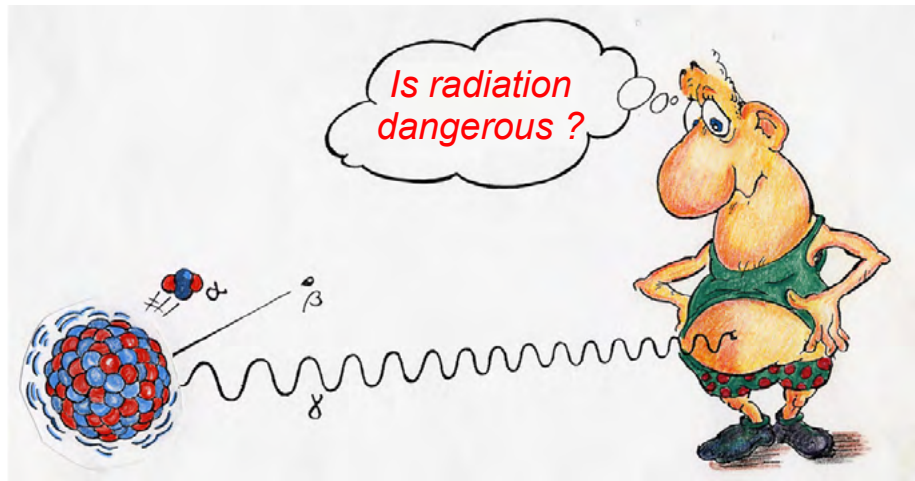

Chapter 13

Radiation and health — Cancer

We are living in a “sea” of radiation. Radioactive isotopes have always been present, and since 1895 we have also had x-rays which is extensively used for diagnostic purposes. In the beginning very little was known about the health effects and the pioneers made a lot of experiments which we today consider as dangerous and foolhardy.



It is quite interesting to read about the pioneers and their work.

The interested reader can consult a new book with the title;

“Radioactivity: A History of a Mysterious Science”

by Marjorie Caroline Malley (published 2011).

In spite of the fact that several of the pioneers were burned due to handling of the radioactive sources with their hands, the radiation was in the beginning of the 20th century considered positive which would bring you good health. For example a number of spas where the water contains low levels of radon was visited by a number of people assuming that the radioactivity can cure ailments such as rheumatism. Places like Bad Gastein, Carlsbad (Karlovy Vary), Marienbad (Mariánské Lázně) and Joachimsthal (Jáchymov) have a large number of guests that appreciate the radioactivity.

The “pendulum” of public opinion with regard to radiation was on the positive side through the first part of the 20th century, and then started to move back after 1945 with the atomic bombs. After Chernobyl the pendulum of opinion was far out to the negative side.

Today, 25 years after Chernobyl the “pendulum” of opinion has started to go back again, mainly due to the work carried out by the cell culture scientists. All this is very interesting and we would all benefit if we could base our opinion and use of radiation on scientific knowledge.

In 1899, Stenbeck and Sjögren from Sweden used radiation to remove a tumor from the nose of a patient (see chapter 10). This demonstrated the positive effect of radiation. Furthermore, the x-ray pictures, which fascinated a whole world, gave more evidence to the positive use of radiation. A more doubtful use of radioactive isotopes is the above mentioned spas, and on the negative side we can mention the use of radioactive isotopes in drinking water, in tooth paste as well as the use of radium and luminous substances in show business. Let us look into some of the foolish use of the radioactive isotopes in the early part of the 20th century.

RADIUM THERAPY

The only scientific apparatus for the preparation of radio-active water in the hospital or in the patient's own home.

This apparatus gives a high and measured dosage of radio-active drinking water for the treatment of gout, rheumatism, arthritis, neuralgia, sciatica, tabes dorsalis, catarrh of the antrum and frontal sinus, arterio-sclerosis, diabetes and glycosuria, and nephritis, as described in

Dr. Saubermann's lecture before the Roentgen Society, printed in this number of the "Archives."

DESCRIPTION.

The perforated earthenware "activator" in the glass jar contains an insoluble preparation impregnated with radium. It continuously emits radium emanation at a fixed rate, and keeps the water in the jar always charged to a fixed and measurable strength, from 5,000 to 10,000 Maché units per litre per diem.

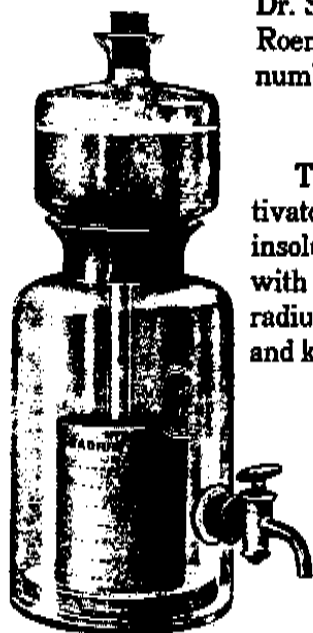

SUPPLIED BY
RADIUM LIMITED,
93, MORTIMER STREET, LONDON, W.
Telephone: 414 MAYFAIR.

Enlarged image



Some doctors prescribed Radithor – it was supposed to cure by stimulating the endocrine system. Instructions on the bottle suggested patients drink from the bottle itself, and swallow an entire bottle after a meal.

It is known that a patient consumed over 1400 bottles of Radithor (more than 100 MBq of these isotopes). Radium works like Barium and Calcium in the human body. When digested, they travel to the bone marrow and remain there to the end of life.

Left:

An advertisement from 1913 for radioactive drinking water.

A jar with water, a cylinder and some radium salt was used. When Ra-226 disintegrates, radon is formed and is released into the water. When the tap was opened, radon was found in the water. The radiation doses were small and the whole system was rather harmless.

From R. F. Mould (1980)

In the advertisement it is mentioned that the activity in the water could be kept at a strength of 5000 – 10,000 Maché. An activity of 10,000 Maché per liter correspond to 3.64 $\mu\text{Ci/l}$ or 130 000 Bq/l.

Below:

Radithor was manufactured from 1918 to 1928 by the Bailey Radium Laboratories in New Jersey. The bottle contained 1 μg of both Ra-226 and Ra-228 (mesothorium) with activity of 37,000 Bq for each of the isotopes.



The isotopes and their decay products yield both α , β and γ -radiation. Another sad story with radium is the “dial painters” –mainly young girls that painted the dials with a mixture of radium and fluorescent materials. Some of these girls got bone cancer. We shall return to this later.

Health effects of radiation

Because large doses of radiation are known to kill cells, there is the possibility of using radiation to treat cancer when localized to a small area of the body. Similar large whole-body doses can lead to death, which occurs in the course of days or weeks.

When considering medium and small doses, the biological effect is considerably more difficult to predict. The reason for this is the time lag between the exposure and the observable biological effect. For solid cancers it is usually several years, even decades.

Marie Curie, and a number of the other radiation pioneers died from cancer. Their working habits involved little or no protection and they may have attained **large** radiation doses – which may have caused their sicknesses.

On the other hand, recent experiments have claimed that **small doses** may even have a positive health effect since radiation has the possibility to stimulate defense mechanisms as well as repair processes(see chapters 11 and 12).

In all discussions on the biological effects of radiation, the radiation dose is a key issue. **Without knowledge about the size of the dose it is meaningless to discuss the effects.** The relationship between the dose and effect is also a hot issue in the community of research scientists. Knowledge about the dose-effect curve is a requirement when discussing mechanisms and health risks of radiation.



Large and small doses

The large dose region can be characterized in the following way:

An acute whole body dose of more than 1 to 2 Gy is considered to be large and a dose smaller than 0.1 to 0.2 Gy (100 to 200 mGy) is considered to be small.

Annual doses in the region 2 – 10 mGy (such as those attained from natural background radiation) are considered to be very small.

A very important aspect is the doserate – whether the dose is given acute or spread out over time i.e. years.

The Use of Large Doses

- **Sterilization of medical equipment.**

Co-60 and Cs-137 γ -radiation are used to sterilize medical equipment. The doses delivered are of the order of 20 to 40 kGy. The purpose of the radiation is to kill bacteria, viruses, and fungi that contaminate equipment.

- **Radiation of food products.**

The purpose is almost the same as for sterilizing equipment. The doses are, however, smaller, on the order of 5 to 10 kGy. Larger doses may change the taste of certain foods.

- **Radiation therapy.**

In Chapter 10 we discussed radiation treatment of cancer. The purpose is to kill the cancer cells while allowing nearby healthy cells to survive. Much effort is carried out to achieve treatment protocols that will give the most effective treatments. The total dose given to a tumor is 10 to 80 Gy. A treatment protocol may include daily doses of 2 Gy, given 5 days per week.

- **Bone marrow transplantation.**

In combination with bone marrow transplantation which is used for the treatment of certain illnesses, whole-body radiation is sometimes used to deplete the original bone marrow. The dose used is about 12 Gy (6 days with a daily whole body dose of 2 Gy). This dose is sufficient to completely destroy the bone marrow and would kill the patient if it were not for the immediate transplant of new compatible bone marrow. A number of people have been treated in this way.

LD₅₀ Dose

By definition, an LD₅₀ dose (abbreviation for “Lethal Dose to 50 percent”) is the dose that could kill 50 percent of the individuals exposed within 30 days. To arrive at a determination of the LD₅₀ dose, experiments like the following must be carried out.

In typical experiments, rats, about 15 animals in each group, were given different whole-body doses. The number of animals dying in the course of 30 days was observed for each group. The result is given in the figure below.

The dose is given along the horizontal axis and the number of animals dying (in percent for each group) is given along the vertical axis. The results show that no animals survived a dose of 10 Gy, whereas all rats survived a dose of 5 Gy. It can be seen that the LD₅₀ dose is approximately 7.5 Gy.

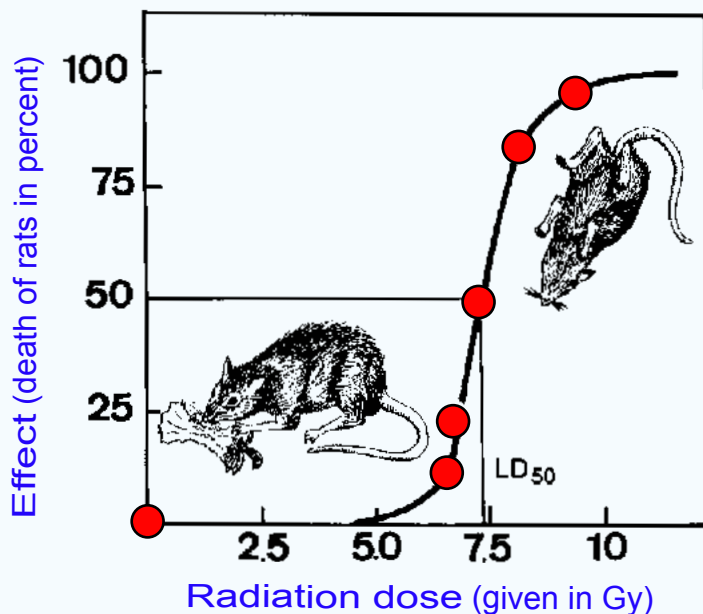

Adapted from A. P. Casarett (1968) with permission of A. P. Casarett

Dose-effect curve for radiation-induced death in rats.



When humans and animals are irradiated, the blood-forming organs (in the bone marrow) will be the first to react. For doses of the order 1 to 2 Gy the number of white and red blood cells will decrease and as a result of this, the immune system will fail and, after one to two weeks, life threatening infections may occur. If the radiation doses are smaller than 4 to 5 Gy, there is a good chance the bone marrow will recover and resume the production of blood cells. This takes place after 3 to 4 weeks and, consequently, 30 days is a reasonably chosen limit for the name *acute radiation death*.

In the radiation accident in Norway in 1982 the whole body dose was determined by ESR to be 22.5 Gy (see page 78 – 81). The man survived for 13 days and the blood values observed in the period are given in the figure below.

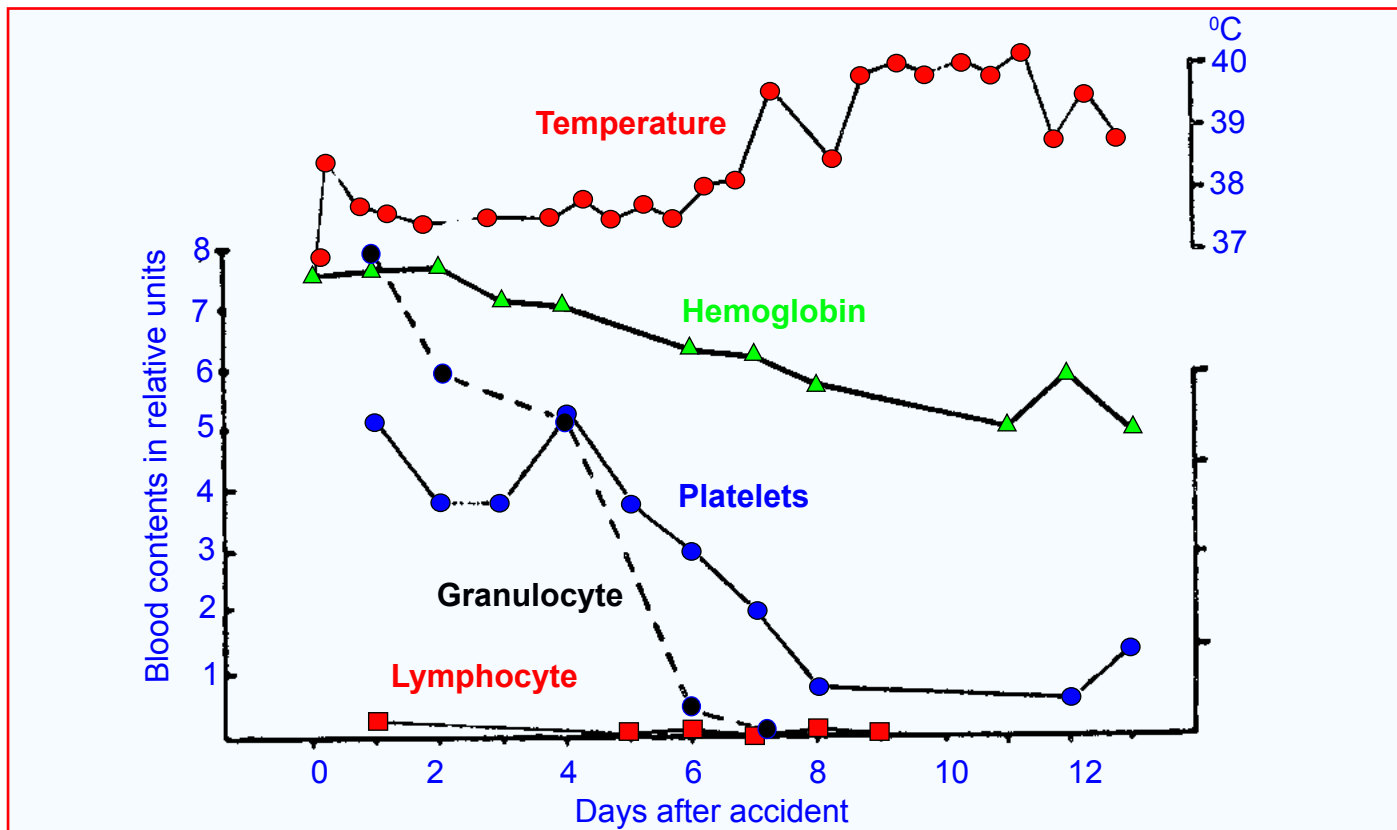

In the figure is given temperature (above) and the different blood values for the technician involved in the radiation accident in Norway. The lymphocytes were already knocked out after 24 hours. He was treated with antibiotics.

The LD₅₀ doses for a number of animals have been determined and some values are given in the table below. Single cell organisms (for example bacteria, paramecium, etc.) may survive doses of the order 2,000 to 3,000 Gy. (This is taken into consideration in radiation treatment of food).

In the case of humans there is not enough information to determine a precise LD₅₀ dose. The only information available has come from radiation accidents and the lethality depends not only on the dose and dose rate but also the post-exposure treatment given to the victims.

Type of animal	Dose in Gy
Dog	3.5
Monkey	6
Rat	7.5
Frog	7
Rabbit	8
Tortoise	15
Goldfish	23
Human	3 – 5 ***

On page 156 the data from Chernobyl is given. 115 were hospitalized with acute radiation syndrome and 28 died. Doses were estimated based on ESR and biological criteria (chromosome aberrations).

From these data a LD₅₀ dose can be estimated. The dose is about 6 Gy! This is somewhat larger than that given in the table.

It can be mentioned that the survival time for the 28 was from 10 days to 3 months – more than the 30 days.

Acute Radiation Sickness

The information on acute radiation sickness is mainly attained in animal experiments. For humans we have only had a few accidents (below 100) where large doses (above 1 Gy) are involved.

In 1906, Bergonie and Tribondeau found that there were different radiation sensitivities for different types of mammalian cells. Cells which grow rapidly (high mitotic rate), as well as undifferentiated cells, are the most sensitive. This implies that bone marrow, testes, ovaries and epithelial tissue are more sensitive than liver, kidney, muscles, brain and bone. Knowledge about this is of great importance for those exposed to ionizing radiation. The bone marrow and the epithelial cells of the intestine and the stomach as well as the gonads, the lymphocytes and skin develop the greatest damage. Damage to the bone marrow is the cause of death for whole-body doses in the region 3 to 10 Gy, whereas damage to the epithelial cells of the stomach and intestine is the cause of death for doses in the range from 10 to 100 Gy. For large doses, above 100 Gy, damage to the central nervous system causes death.

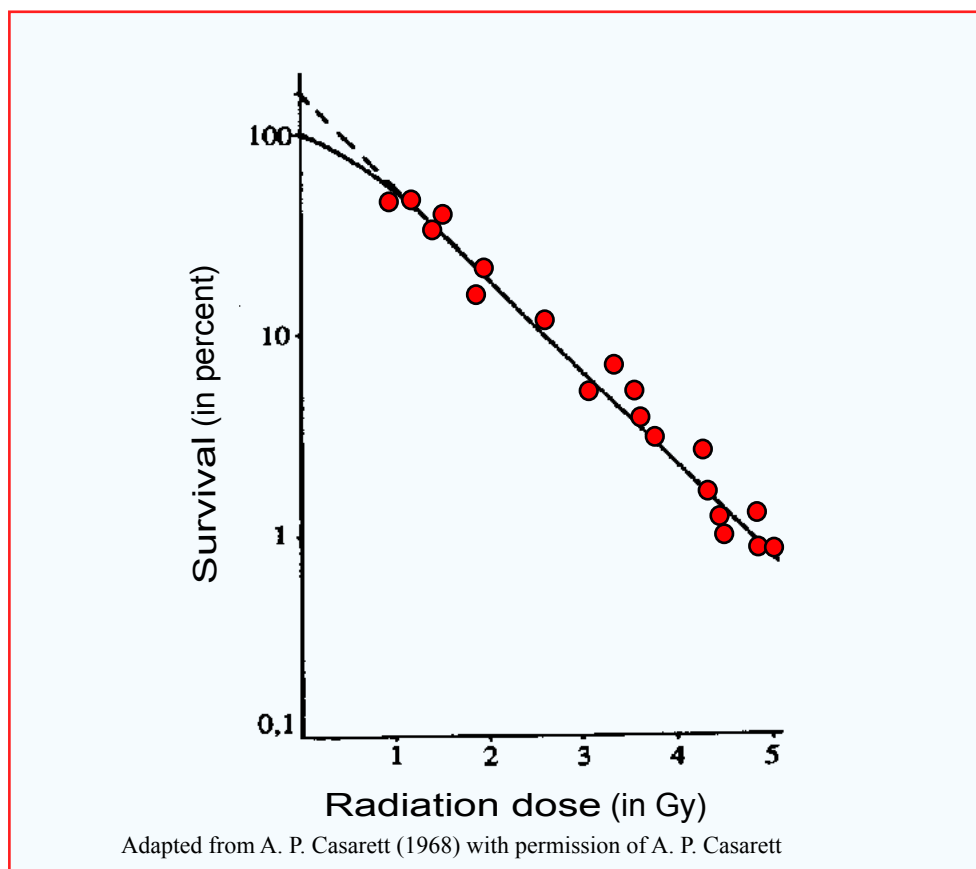

Survival curves for bone marrow cells of the mouse after irradiation with Co-60 γ -radiation.

- **Hematopoietic syndrome**

As mentioned above, the failure of the bone marrow is the cause of death for whole-body doses in the range of 3 to 10 Gy. The radiation may either kill these cells or arrest their development. A dose of 5 Gy will kill about 99% of the hematopoietic stem cells in mice. These stem cells are necessary for the production of circulating blood cells (erythrocytes, granulocytes and platelets). A reduction of these cells will result in anemia, bleeding and infections.

The first sign of such radiation sickness is nausea, vomiting and diarrhea. This situation may disappear after a couple of days. Then, the consequences of lost blood cells become evident. Again, significant diarrhea may take place, often bloody, and a fluid imbalance may occur. This, together with bleeding, occurs in all organs. In addition, if infections occur, death may take place in the course of a few weeks.

- **The gastrointestinal syndrome**

For whole body doses of 10 to 100 Gy, the survival time is rarely more than one week. Damage to the epithelium of the intestine results in significant infections from the bacteria in the intestine itself. The production of blood cells is almost completely stopped, and those remaining in the blood disappear in the course of a few days. After 2 to 3 days almost all granulocytes will have disappeared from the circulation.

The symptoms are pain in the stomach and intestine, nausea, vomiting and increasing diarrhea. A considerable loss of liquids and electrolytes will change the blood serum composition. There is an increased chance of infections.

- **Central nervous system syndrome**

For radiation doses above 100 Gy, the majority may die within 48 hours as the result of the central nervous system syndrome. The symptoms are irritability and hyperactive responses (almost like epileptic attacks) which are followed rapidly by fatigue, vomiting and diarrhea. The ability to coordinate motion is lost and shivering occurs followed by coma. Then respiratory problems occur which eventually lead to death.

The symptoms described are due to damage to the brain, nerve cells and blood vessels. Immediately, permeability changes take place in the blood vessels resulting in changes in the electrolyte balance. The loss of liquid from the blood vessels leads to increased pressure in the brain. It is possible that the respiration center in the brain is particularly damaged. Autopsies have shown that some animals die without visible damage to the brain.

Small Doses and Risk Estimates

With regard to human health it is rather difficult to describe the effect of small doses – both acute doses and protracted. We consider a small dose to be below about 200 mGy acute, and about 1 Gy given in the course of 5 to 10 years.

In most experiments with cells, plants and animals, large doses have been applied with clear and significant results. When the doses become smaller the effects decrease and become less clear. In order to compensate for this, the number of subjects (e.g., animals) can be increased. However, for the region where very small doses are involved (e.g., from an annual dose of a few mGy up to an acute dose of about 50 mGy), the number of animals or humans must be so large that it is very difficult (usually impossible) to conduct experiments and/or epidemiological studies. In epidemiological studies, attempts are made to correlate the radiation dose to the incidence of biological effects such as cancers in a large group of people. Some examples are the populations that have been exposed to radon, those exposed to the bombs at Hiroshima and Nagasaki, and those exposed during the Chernobyl accident. Such studies have yielded both conflicting and confusing results. They are, however, of considerable interest to scientists and to the public.

With regard to human health we shall discuss two effects where we know something about the mechanisms – namely **cancer** and **genetic damage**. The startpoint for both is a DNA-damage resulting in a mutation – either in a somatic cell or in an ovary or sperm producing cell.

Since the number of sex cells is small compared to somatic cells, the number of damage would be very different. For both these mechanisms all the defense processes we have outlined in chapter 12 comes into play.

The studies involving both cancer and genetic effects started a long time ago, before the mechanisms involving DNA was known. Consequently, in the beginning and all the way up to present the epidemiologists were the frontfigures and they tried to ascribe the dose-effect curves in a simple way like the LNT-model.

We shall first discuss genetic effects and then see in more detail into cancer.

Genetic Damage

Fruit fly

In 1927, Hermann Muller observed that ionizing radiation causes mutations. He worked with the fruit fly (*Drosophila melanogaster*) and used x-rays and found an increased mutation frequency in the X-chromosome. This was the starting point for radiation genetics.

Drosophila melanogaster was a major workhorse behind the early 20th century genetic revolution. Thomas Hunt Morgan used the fly's fast reproductive cycle and simple care requirements to elucidate the fundamentals of heredity.

The fruit fly is an excellent model system; it is inexpensive, easy to work with and exhibits genetic changes that are easy to observe (see an example below).

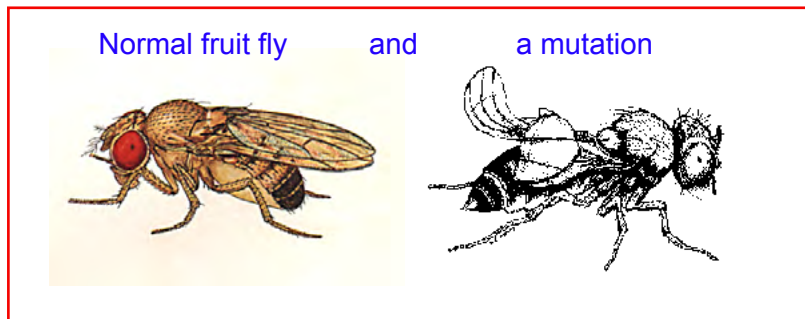

The observable genetic changes are, for example, the color of eyes and defects to the wings (as in the figure). If you compare this fly with the normal one, you can easily observe curled wings.

The fruit flies are rather small and the observations are made using a magnifying glass. The flies can be kept in glass jars, and may be anesthetized with ether in order to keep them quiet during observation.

Mice – “The megamouse experiment”

Most of the knowledge about radiation-induced mutations was obtained through laboratory experiments. For example, irradiated mice have been studied extensively for years.

At Oak Ridge Liane and William Russell carried out an experiment including altogether about 7 million mice. “*The mega mouse experiment*” provided evidence for seven different types of mutations (changes in the fur color, the ears, etc.). Radiation had increased the number of mutations, and the results can be summed up as follows:



Liane B. Russell
(1923)



William L. Russell
(1911 – 2003)



Hermann Joseph Muller
(1890 – 1967)

Hermann Muller started his career with T.H. Morgan studying mutations in fruit flies. He used X-rays for inducing the mutations.

In 1927 he published the work; “*Artificial Transmutation of the Gene*” in *Science*. Here he described how the radiation yields observable mutations in the X-chromosome.

The Nobel Prize in Physiology and Medicine for 1946 was awarded to Hermann J. Muller; “for the discovery of the production of mutations by means of X-ray irradiation”.

1. The radiation sensitivity for the different types of mutations varied by a factor 20.
2. With mice, a significant dose-rate effect was found, the mutation frequency increases with increasing dose rate. Consequently, a protracted dose yielded a smaller effect. This result was not found in the fruit fly experiments.
3. Male mice were more radiosensitive.
4. The number of mutations for a certain dose decreased with the lapse of time between radiation and conception. This seems to be equal for the two sexes.
5. Spontaneous mutations always take place. One possible source of these mutations is background radiation. The animal experiments seem to indicate that background radiation accounts for about 2% of the spontaneous mutations.

A significant question in these early days was the so-called “*doubling dose*” which is the dose that doubles the mutation frequency. The experiments with mice indicated a doubling dose of 1 – 2 Gy.

Children of the atomic bombs

For a number of years the two Americans James V. Neel (1915 – 2000) and William J. Schull have studied the children of the atomic bomb survivors in Japan.

Approximately 70,000 children have been registered where the parents received radiation doses of about 350 mSv. This cohort has been studied carefully for the incidence of; stillborn, child death, deformities, death before the age of 26, an abnormal number of chromosomes, and changed ratio of girl/boy.

The conclusion is that no genetic effects have been detected. This implies that there is no detectable radiation-related increase in congenital abnormalities, mortality (including childhood cancers), chromosome aberrations, or mutations in biochemically identifiable genes.

J. V. Neel and W. J. Schull concluded that the doubling dose for humans is about 2 Sv for acute radiation and about 4 Sv for protracted radiation. In the view of these results, genetic effects from the Chernobyl accident are not expected to be detected. Furthermore, “chromosomal structural changes are likely to be of comparatively little importance among the radiation hazards to man”

If a genetic study should be carried out today it would include studies at the DNA level. It must also include most of the components of the study in Japan, such as; frequency of congenital malformations and still births, death rates among live-born children, growth and development of surviving children, cancer and chromosomal abnormalities in children of those exposed. A study of the genetic effects of ionizing radiation must include a DNA component.

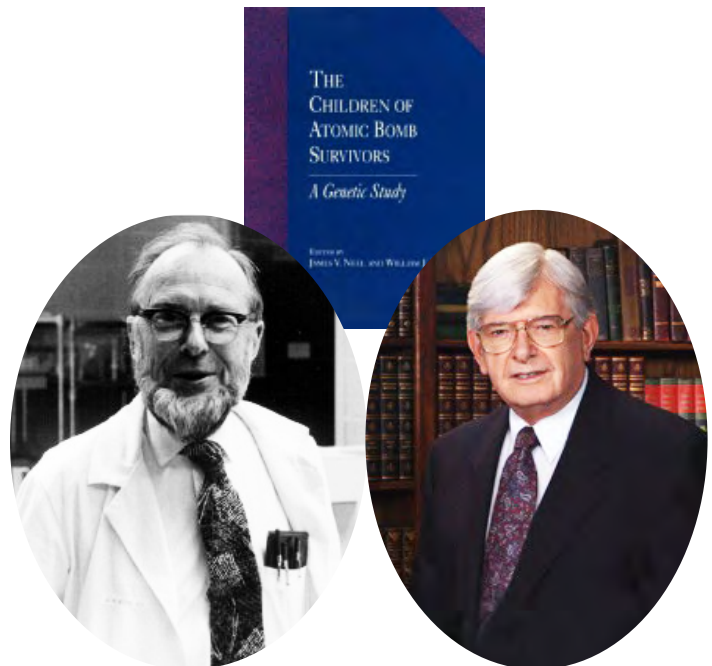

James V. Neel

William J. Schull

The two authors of the book:

The Children of Atomic Bomb Survivors

Cancer

Cancer is a disease in which abnormal cells divide without control. Behind this basic definition is a complex and unpredictable spectrum of over 100 types of cancer. When a cellular mechanism goes wrong, the resulting damage, if not repaired, may contribute to a cell's evolution into malignancy. Cancers begin with a DNA-damage in a single cell. The damage may be due to both endogenous as well as exogenous processes. A useful picture is that we have a pool of damaged cells that can be triggered into a cancer development.

It's impossible to comprehensively review current cancer research; the amount of information is enormous and the rate of discovery is increasing. In the preface to the book "*The Biology of Cancer*", Robert Weinberg writes; "*we are deluged with a vast amount of genetic, biochemical, and cell biological information about cancer development, far more almost than any human mind can assimilate and comprehend*".

Carcinomas which comprise more than 90% of human cancers, arise from epithelial cells of either endodermal or ectodermal origin. They are further classified according to tissue of origin, or divided into different histologic types that differ in their patterns of growth and metastasis.

Sarcomas and the leukemias/lymphomas develop from cells of mesodermal origin, including muscle, bone, blood vessels, fibroblasts, and circulating cells of the blood and lymph systems.

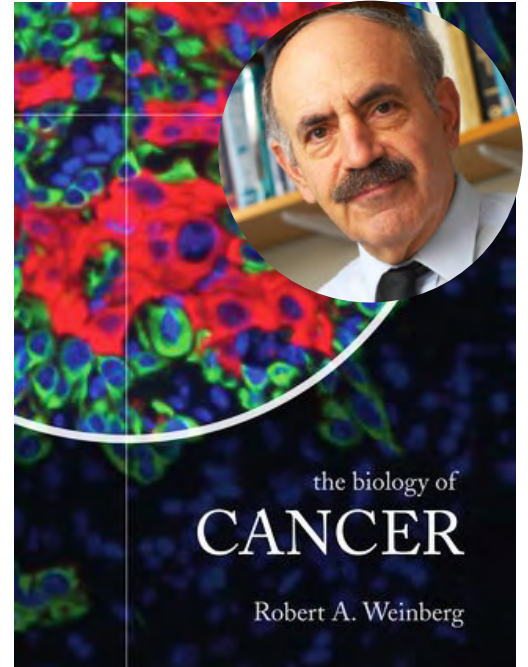

The goal

During the years we have had individuals that have got cancer due to ionizing radiation. Some of the pioneers and some of the doctors that used radiation without protection are among these individuals. In all these cases it is not possible to arrive at any dose determination. With regard to the use of radiation and to the use of nuclear energy it is important to have some knowledge about the dose-effect curve for radiation. The goal is to get information on "*the dose-effect curve for small radiation doses*" and how we (the radiation authorities) should establish a protection system. Today the protection system is based on the LNT-hypothesis (Linear No Threshold), assuming that all radiation is deleterious.

Up to now the major source of information for evaluating health risks from exposure to radiation is the LSS-group (Life Span Study) of survivors after the Hiroshima and Nagasaki bombs. The LSS cohort consists of approximately 87,000 survivors who were in the city at the time of the bombings and for whom it is possible to estimate the dose level. The size of the cohort in Hiroshima which was within 2000 m from the hypocenter was approximately 28 000. They may have attained doses above 8 mGy.

Great efforts have been made to determine the radiation dose, which consisted of γ -radiation and neutrons. The dose was given at a very high dose rate together with the blast. ***This implies that some of the protection and repair processes discussed in Chapter 12 are not working.*** Consequently, the results from the bombings would not be valid in other situations where the doses are given with a low dose rate – including the cohorts exposed in and after reactor accidents.

We shall first go through some of the available information we have on irradiated groups, including the LSS cohort. We mentioned above that some of the pioneers in the radiation field died from cancer. Furthermore, a number of first radiologists got skin cancer and that uranium miners suffered from lung cancer. In these cases the radiation doses must have been large.

Different irradiated cohorts

The dial painters

In the first part of the 20th century, the numerals and hands on some clocks were painted with radium. Radium paint was still used in dials as late as the 1960s. Women were employed to do the painting. Sometimes they ingested small amounts of radium because they “pointed” their brushes by licking them.

Radium is a bone seeker and some of the women contracted bone cancer later in life.

A large amount of work has been carried out with the purpose to determine the intake, doses and health effects for all those exposed to Radium. A report from R.E. Rowland from Argonne National Laboratory was published in 1994. In the 1990s three books about the dial painters have been published: “*Radium Halos*”, “*Radium Girls*” and “*Deadly Glow*”.



An illustration of radium painters

Let us try to give some of the main points. From about 1917 it became an industry in USA to paint the dials and numbers on the clocks with a mixture of radium and fluorescent materials. It was mainly young girls (20 – 30 years old) that did the painting. On this page is an illustration from D.W. Gregory's play “*Radium girls*”, and on the next page you can see a picture from a studio in Illinois in 1925.

The radioactive paint consisted of a mixture of Ra-226 (from the Uranium series) and Ra-228 (from the Thorium series). The α -particles from the radioactive isotopes bombarded luminous materials such as barium bromide (BaBr), zinc sulfide (ZnS) and others – which resulted in a constant glow that could be seen in the dark.

More than 2000 young women were engaged. Each girl handled about 1 mCi radium per month (37 MBq). In this work the girls were exposed to external as well as internal radiation which including both α , β and γ -radiation. We are faced with the following radiation scenario:

1. The radium isotopes resulted in radon. The radon level in the working room was about 2000 Bq/m³.
2. The girls were exposed to external γ -radiation from the radium sources. The dose level has been calculated to be up to 460 mGy/year. The breasts are most exposed.
3. The girls were exposed to α -radiation from the intake of Ra-226 and Ra-228.

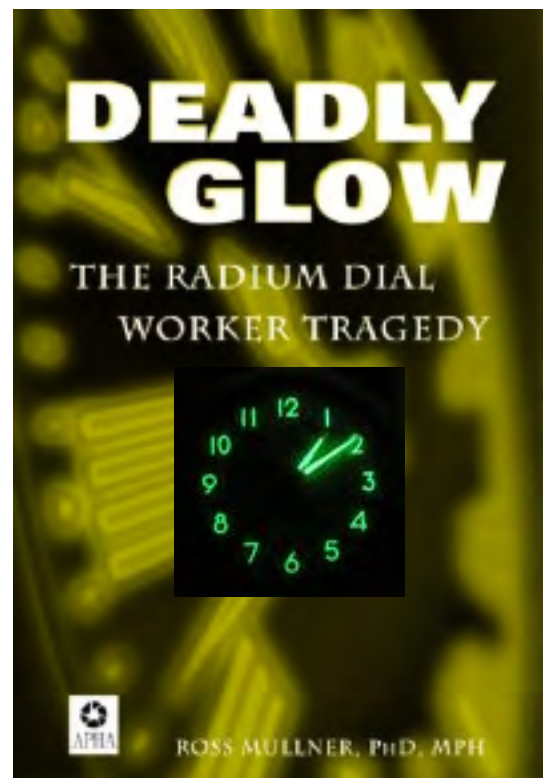

Dial painters 1925



Ra-226 from the Uranium series has a half-life of 1600 years. It ends up in the stable isotope Pb-206. In the decay processes 10 α -particles are involved. Ra 228 from the Thorium series has a half-life of 5.8 years. It ends up in Pb-208. In the decay scheme 6 α -particles are involved.

We can conclude that the dose rate is rather low, and completely different from the atomic bombs in Japan.

When these isotopes are inside the body it is the α -particles that give the main contribution to the radiation dose. However, it is the γ -radiation from the decay processes that can reach the outside and consequently give the basis for measurements (in recent years whole body measurements).

A large amount of work has been carried out to localize those working in this industry and which have been exposed to radiation. The total number identified was 4133 (3637 women). Approximately 2500 were measured in order to determine the radiation doses. A significant part of the work has been carried out by Robley D. Evans. He introduced the method to use the γ -radiation to determine the radium in the body.



Robley D. Evans
(1907 – 1995)

Evans established “*Center for Human Radiobiology at Argonne National Laboratory*” in 1968. They published the work on “*Radium in humans*” in 1994. The radium dial painters, mainly young girls, were a considerable part of this work.

The work with the dial painters (all those exposed to radium) included the following items;

- a). To identify all the dial painters,
- b) To measure the radioactivity in the body and thus estimate the total intake and
- c). To determine the health history for those exposed.

Let us note that a significant intake in the case of the dial painters was due to the fact that the girls licked the brushes to sharpen the tip. In 1926 it was urged that the girls should stop this licking – which certainly helped. No cancers were observed for those starting after 1930.

Measurements

Radium is taken up and deposited mainly in the bones. In order to calculate total doses to the individuals, both radioactive decay as well as biological excretion must be considered, i.e. we try to find a biological half-life. A decay curve has been found and used – the retention of Ra-226 is about 2.5 % at 1 year and about 0.33 % after 50 years. This implies that the intake of radium can be estimated from measurements at later times – and this again can give an estimate of the accumulated body dose. The total skeletal dose varied considerably with the highest values up to 280 Gy.

In the large Argonne work altogether about 6000 people are included. The names of about 5000 are known, 3500 have been localized and about 2500 have been measured.

Health effects

In spite of the large doses to all parts of the body only two types of cancer have been diagnosed – 64 bone sarcomas and 32 head carcinomas. The total doses for those with bone sarcomas varied from 11 to 278 Gy – and for those with head and neck carcinomas the total calculated dose varied from 8.6 to 158 Gy.

From a population of 2,383 cases for whom reliable body content measurements have been done – all the 64 bone sarcoma cases occurred in the 264 cases with more than 10 Gy, while no sarcomas appeared in the 2,119 radium cases with less than 10 Gy.

The great majority of exposed individuals went through life with no recognizable consequences of their exposures. They lived as long as, and apparently in as good health as, their unexposed neighbours. This fact seems to have been little appreciated and seldom mentioned, but it may be the most important finding of the entire study. No leukemias, no breast cancer and no lung cancer in spite of the rather large doses given at a low dose rate.

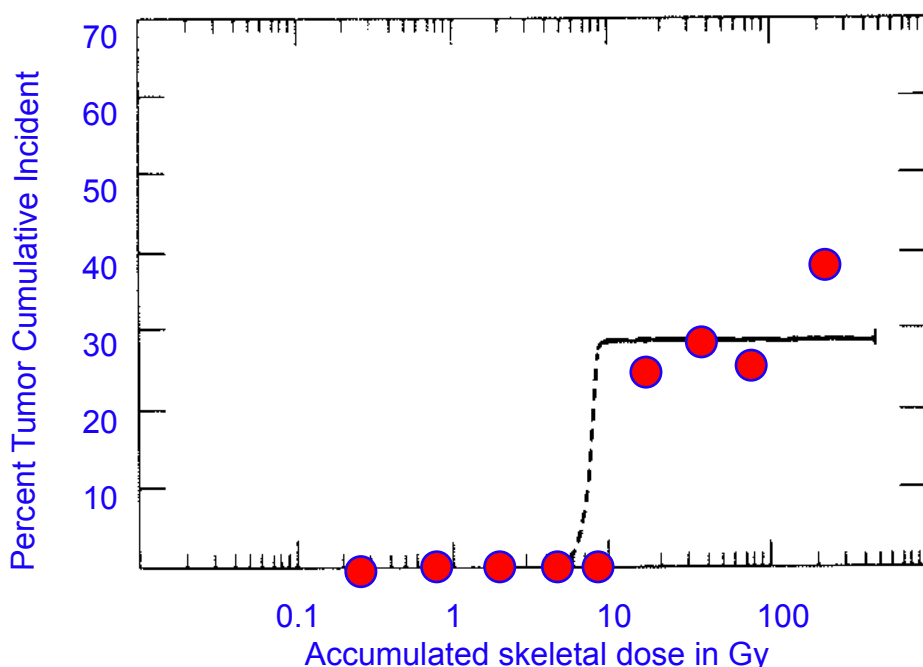

The figure above is the dose-effect curve for the relation between radium intake (resulting in skeletal dose) and cancer (Evans data).

Radon and lung cancer

Radon and lung cancer was treated on pages 110 – 123. It was concluded that for miners working in an atmosphere of radon + a number of other carcinogens including smoking it was a connection that could be ascribed by a linear curve *with a threshold*. The data for the miners can not be used for radon in homes. The newer studies of radon in homes and lung cancer has been described both by a linear dose-effect curve and by a curve including a hormetic region up to a radon level of about 1000 Bq/m³ (see page 120 – the Schneeberg data).

Chest fluoroscopy and breast cancer

Several years ago when tuberculosis was more frequent, patients were examined with x-rays. A number of x-rays and fluoroscopies were performed in combination with pneumothorax treatment (see Chapter 9, page 214). The idea was to give the lungs some rest which was accomplished by collapsing the lung with air. The treatment could last for several years and the patient needed more air every second week. Each fill of air required more x-rays and the doses could be significant.

The weak point here is that no dosimetry was done at the time, and reconstructions give only an idea of the dose involved. The total dose was spread over time. Some observations done in recent years indicate an increase in breast cancer for the largest doses (page 214). The same figure indicate hormesis for the lower dose region.

For a while, a radioactive material (thorotrast) was used as a contrast medium in x-ray diagnoses. Increased cancer incidence (liver cancer) has been observed among patients so treated, particularly in Germany and Japan.

Atomic bombs – Hiroshima and Nagasaki

The only two atomic bombs dropped in an area with people are those in Hiroshima and Nagasaki in August 1945. Large amount of work has been performed to determine the biological effects of these bombs. We have several places through the book described effects and discussed physical and genetic consequences. We shall now once more discuss the radiation from the bombs and the occurrence of cancer that can be attributed to this radiation.



A model of Hiroshima and the first nuclear bomb 6th of August 1945. The bomb exploded 600 meters above ground. The fire ball is indicated by the red ball. The explosions released a large amount of energy in the form of; 1) heat (about 35 %), 2). blast or pressure (about 50 %) and 3) radiation (about 15 %). About 5 % is prompt radiation consisting mainly of γ -radiation and a small fraction of neutrons, and about 10 % is delayed (i.e. fallout isotopes). The prompt radiation is given within seconds. In all the subsequent discussion about the radiation effects it is the prompt irradiation we are discussing.



The picture to the left is taken in 1945. It shows the ruins of the former Hiroshima Prefectural Industrial Promotion Hall (called Genbaku Dome) close to “Ground zero”. Below you see Genbaku Dome in August 2010. In 1996 this memorial was included in UNESCOs “World Heritage List”



The radiation quality

Approximately 3 – 5 percent of the energy released in a nuclear bomb is prompt irradiation, i.e. γ -radiation and neutrons. This radiation decreases rapidly with the distance from the point of explosion (inverse square law) as well as by absorption, scattering, and capture by the atmosphere.

The dose level in air as a function of the distance from the hypocenter has been obtained by calculations, and also from observations of thermoluminescence (γ -radiation) as well as induced radioactivity from neutron reactions (n,γ reactions). The neutron intensity decreases rapidly and becomes negligible in comparison with the gamma component.

The range for significant levels of radiation does not increase markedly with the weapon yield. For Hiroshima and Nagasaki the dose levels 1 m above ground in the open field 1 km from the “ground zero” (at the surface below the blast), were estimated to 4.22 Gy (Hiroshima) and 8.62 Gy respectively, while at 2 km the doses were 0.08 and 0.14 Gy (Dosimetry System from 2002). Thus, only within a distance of about 1 km the radiation itself may be fatal. However, in this zone the blast and thermal effects are much more important than the prompt irradiation.

In the table below is given the estimated population size and number of acute (within 1945) deaths in Hiroshima and Nagasaki after the atomic bombings.

City	Estimated city population at the time of the bombings	Estimated number of deaths within 1945
Hiroshima	340,000 – 350,000	140 000
Nagasaki	250,000 – 270,000	70 000

The cause of death was flash or flame burns and falling debris. During the following months, several died from the effect of burns, and other injuries. From what we know about acute radiation death, very few were exposed to doses large enough to cause death alone. For those that attained such large doses would be killed by the blast and heat.

Dose calculations

In 1950 it was assumed that about 280,000 people have been exposed to radiation because of the bombs. It is an impossible job to determine individual doses to all these people. However, a tremendous job has been done and dose estimations have been published in 1966, 1981 and 1986 – and again in 2002. Small changes in the position of the blast have been introduced between DS86 and DS02.

Let us mention some of the problems with regard to doses.

- 1). Neutrons are readily absorbed by water. Consequently, the weather conditions and humidity are of importance for the dose evaluation.
- 2). The bomb material which envelopes the fissionable material (U-235/Pu-239) is important. In Hiroshima and Nagasaki iron was used and a heavier metal in the nose and tail. This would slow down some of the neutrons and absorb some of the γ -radiation. Some years ago the assumption was that the neutron doses were large in Hiroshima compared to those in Nagasaki. Later, new calculations showed that the neutron doses in Hiroshima had to be reduced and the γ -doses set higher.
- 3). To estimate individual doses, knowledge is needed about the location of the person during the blast and what kind of protection he or she had (being indoors, outdoors, etc.). These reconstructions are based on the survivor's testimony, taken some years after the bombs fell. At times, the stories were vague, and some doses were immediately deemed impossible to calculate.
- 4). Some years ago, it was found that the estimated position of the centre of the explosion at Nagasaki had to be changed by 37 meters. This may sound trivial, but the result was that some persons had to be moved from one dose group and placed into another. Similar small differences were also introduced in the DS02 calculations.

Health effects

All the time since the bombs were dropped the health of those survived has been followed. In 1947 the “**Atomic Bomb Casualty Commission**” (ABCC) was established. The purpose was to study the health of the A-bomb survivors. This organization was reorganized in 1975 when RERF (“**Radiation Effects Research Foundation**”) was formed.

The objective of the RERF is to conduct research, for peaceful purposes, on the medical effects of radiation on man, with a view to contributing to the health and welfare of the atomic-bomb survivors and to the enhancement of the health of mankind.

Information on early effects of the radiation was obtained by interviewing more than 100,000 atomic-bomb survivors, primarily from 1956 to 1961. Among the acute radiation symptoms recalled by survivors, epilation (hair loss) is regarded as the most reliably reported. In general, acute radiation symptoms do not appear at low-dose radiation exposures. That is, below a certain radiation dose, no acute symptoms occur.

In order to investigate late effects, 94,000 survivors were selected and registered as a cohort, LSS (Life Span Study). Individual doses to 86,611 survivors were determined. In the period from 1950 – 2000 it was 47,685 that died from all causes. With regard to cancer it was 10,127 that died from solid cancer and 296 from leukemia. It is quite uncertain how many of these cancers were due to the radiation in 1945, but the number is assumed to be approximately 500. In 1990 the number was assumed to be 429 and in 2006 it was assumed to be 527, – of them 87 from leukemia and 440 from solid cancers.

Dose effect curve

Using the latest dosimetry system (DS02) the statistical analysis supports a linear-quadratic dose response model for solid cancers. Previous analysis have been interpreted in accordance to the LNT model. For leukemia a linear-quadratic model gives the best fit – even a hormetic region can be suggested.

Studies on the LSS cohort have shown an increase in cancer for the group with doses in the range of 200 – 500 mSv. Hazard values for doses below 200 mSv are speculations.

It can be noted that the doses calculated are given in sievert (Sv). The radiation here is mainly γ -radiation and consequently the radiation weight factor is 1. This implies that we attain the same numerical value if the dose is given in gray (Gy).

Comments

1. Little information exists about the accumulated doses received, as well as of the variation in doses from one person to another *after* August 1945. It is reasonable to assume that in the period since 1945 the accumulated equivalent dose is on the order of 150 to 300 mSv. This equivalent dose, and in particular its variation, is very difficult to take into consideration.
2. Health end points other than cancer have been linked to radiation exposure in the LSS cohort. A dose-response relationship with mortality from nonneoplastic disease was demonstrated in 1992, and subsequent analyses in 1999 and 2003 have strengthened the evidence for this association. Statistically significant associations were seen for the categories of heart disease, stroke, and diseases of the digestive, respiratory, and hematopoietic systems. The data were inadequate to distinguish between a linear dose-response, a pure quadratic response, or a dose-response with a threshold as high as 0.5 Sv.
3. The doses in free air out from the hypocenter have been calculated with rather high quality. However, individual doses are a quite different story. Since the uptake of the individual stories were made several years after the bombing a lot of errors will be present. We have no way of calculating the dose for a person exposed in a street car. We're not sure how many people were standing between a person and the bomb. When the bomb hit, some persons were standing, some sat and so on.
4. There were no radiation monitors in the cities, of course, so the number of gamma rays and neutrons released by the bombs had to be estimated. This was easy for the Nagasaki bomb, since this type was used in numerous weapons tests, while leaving lasting traces in the atmosphere, provided a wealth of data. Nuclear scientists even built replicas of Japanese homes in the bombs' radius.
5. Hiroshima's bomb, "Little Boy," was the challenge. The bomb was unique, shooting two uranium cores together for its explosion. The Manhattan Project had never tested it, and the United States never built a similar bomb. This left doubts about the theoretical estimates made of Little Boy's radiation, especially the neutrons it released. There seemed to be disagreements between concrete activated by the bomb and calculated doses. It was called the "Hiroshima discrepancy." There was only one possible solution: They had to resurrect Little Boy in 1982.
6. The doserate was very large. Consequently, we can not expect that all the defense mechanisms, discussed in Chapter 12, took place.

The conclusion of this is that the LSS cohort and the radiation effects to this group have very limited value with regard to a protection system that can be used by the radiation authorities in the case of reactor accidents, and for protection threshold values in general.



The picture above is from the 6th of August 2011 the 66th anniversary of the world's first atomic bombing in Hiroshima. People pray after releasing paper lanterns on a river facing the Genbaku Dome.

The Taiwan cohort

In 2006, W.L. Chen and coworkers published the paper “*Effects of Co-60 Exposure on Health of Taiwan Residents Suggest New Approach Needed in Radiation Protection*”¹.

The paper is about an almost unbelievable story from Taipei in Taiwan. It was observed, accidentally, that a number of apartments had been contaminated with Co-60 gamma-radiation.

Approximately 10,000 people occupied these buildings and received a rather large radiation dose during a period of up to 20 years.

The above mentioned paper is about all the work carried out to determine dose level and accumulated doses as well as the medical work connected to this irradiated group. Some unexpected results were obtained.

The apartments were built mainly in 1983 and they used recycled steel, accidentally contaminated with cobalt-60. The first “radioactive” apartments were discovered in 1993, and later more apartments, altogether more than 1700 were found. The contaminated buildings included both public and private schools as well as some small businesses, in Taipei City and nearby counties. About ten thousand people occupied these buildings for 9 to 22 years.



¹ <http://www.ncbi.nlm.nih.gov/pmc/articles/PMC2477708/>

Co-60 has a half-life of 5.27 years. It decays by emitting one β -particle – followed by the emission of two γ -ray photons with energy of 1.17 MeV and 1.33 MeV respectively. On page 24 in Chapter 2 you can see the decay scheme.

The γ -radiation is “whole body irradiation”. Considerable work was carried out in 1996 to determine the dose-rate at that time. Ionization chambers as well as thermoluminescence dosimeters (TLD) were used. In order to explore the doses to the residents a Rando phantom was used. This phantom is divided into 2.5 cm slices that can be filled with dosimeters.

In December 1996, the AEC estimated that 20% of the residents received an annual (1996) dose in the range from 5 to 160 mSv (or mGy). This implies that 80% of the residents received a dose of less than 5 mSv. The dose level in the houses during the period 1983 to 1996 can be determined very good by the measurements in 1996. However, the whole body doses to the residents are very uncertain and depends on the time spent in the different apartments. This implies that we have limited information about individual doses.

A crude estimate of the average 1996 dose for 3 different cohorts is as follows:

1. High cohort (~ 1100 people) = 87.5 mGy
2. Medium cohort (~ 900 people) = 10 mGy
3. Low cohort (~ 8000 people) = 3 mGy

The calculated mean annual dose received by all the residents in 1996 was about 13 mGy. You can easily calculate that this dose level corresponds to approximately 74 mGy/year in 1983.

We can use this and get an information of accumulated doses to the residents in the three groups or cohorts.

Number of exposed people and doses are given in the table below:

Cohort	Number of people	Mean annual dose 1983 (in mSv)	1983 – 2003 individual dose (in mSv)	1983 – 2003 Collective dose (person-Sv)
High	1 100	525	4000	2,260*
Medium	900	60	420	378
Low	8 000	18	120	960
Averaged	10 000	74	600	6 000
Adjusted	10 000	49	400	4 000

* From July 1996, 50 % of the residents relocated. Approximately 10 000 people are involved altogether. The adjusted doses are calculated on the assumption of the residency factor of about 0.7.

Let us made this short by saying that the the size of the cohort is 10 000 and they got a “collective dose” in the period 1983 – 2003 of approximately 4000 person-Sv and individual doses up to 3 – 4 Gy.

Health effects

Residents with annual doses above 5 mSv were examined in AEC (Atomic Energy Commission) hospitals. Some residents were later examined in Hiroshima.

The examinations revealed no harmful radiation sicknesses. When the residents in one of the highly radioactive buildings sued the government for compensation, the concerned hospitals testified that they had no evidence that the radiation had caused any harmful effects.

The harmful effects in question were cancer and congenital malformations (birth defects). The mean cancer mortality in Taiwan in the period 1983 – 2002 is 116 deaths per 100,000 person-years. It increased in this period as seen in the figure below. In Norway the cancer mortality is higher with about 220 deaths per 100 000 person-years.

For a population of 10,000 the number of cancer deaths expected for the 20 year period 1983 –2002 is 232. The observed cancer deaths for the Taiwan cohort is given in the figure below. The total cancer deaths for the cohort was 7 – only 3 % of that expected for the general population.

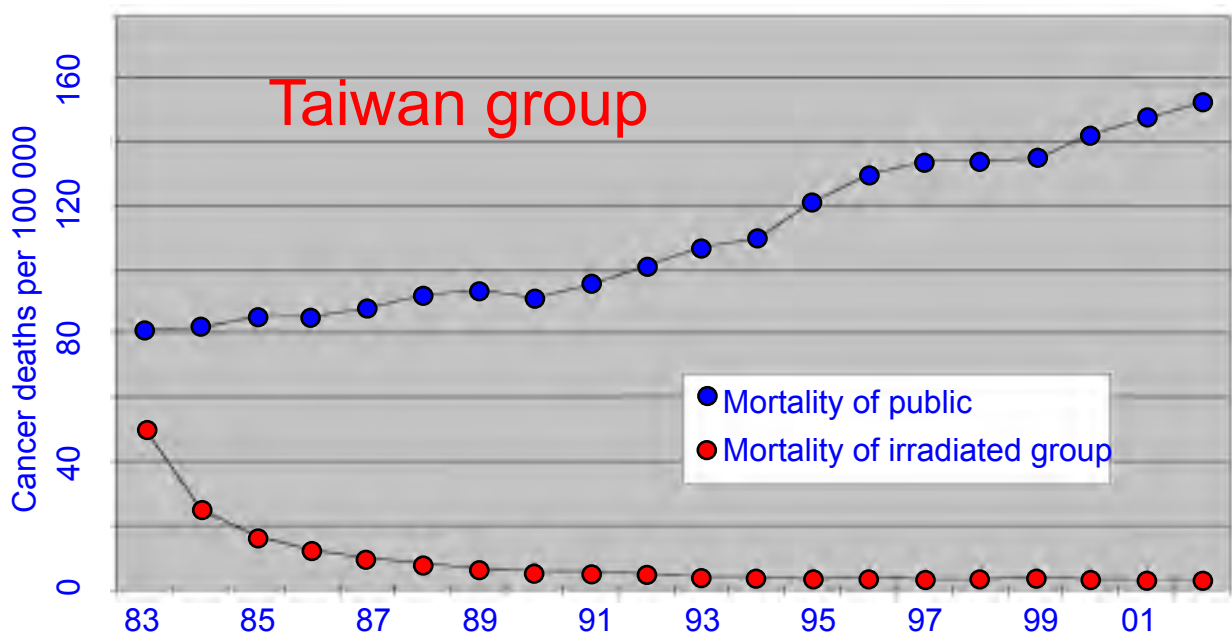

Congenital malformation was the other harmful effect studied. There is no official statistics with regard to the rate of congenital malfunctions in Taiwan, but an incidence of 46 children was expected. It was found only 3 children with congenital malformations in the cohort (heart disease). This is about 6.5 % of the rate for the general population.

Summary

The results of the Taiwan study strongly suggest that whole-body chronic irradiation, in the dose rate range that the apartment residents received, *caused no symptomatic adverse health effects*, such as radiation sickness, or the increased cancer or increased congenital disease such as predicted by ICRP theories. On the contrary, those who were exposed had lower incidences of cancer mortality and congenital malformations.

The results from the Taiwan cohort demonstrate the beneficial health effects from chronic exposures to low dose rates of ionizing radiation. We have in this book demonstrated that low dose-rate irradiation stimulate the cells defense mechanisms – and that small doses can be beneficial. These results must be analyzed and will hopefully introduce a change in our view on radioactivity and radiation in general.

We quote from Chen et al. article.

The medical evidence from this study clearly suggests that current radiation protection policies and standards are inappropriate. We therefore recommend that the radiation protection authorities change them to accurately reflect the actual benefits and hazards of exposures to radiation. This would have very important consequences for all the nuclear risk assessments carried out and the public attitudes toward all applications of nuclear and other technologies that involve ionizing radiation. Fear of small doses of radiation is the basis for political barriers blocking the construction of nuclear power plants and nuclear waste management facilities.

Risk calculations – dose-effect curves – LNT-theory

The international body for radiation protection is the “*International Commission on Radiation Protection*” (ICRP).

ICRP was established in combination with the second international congress in radiology in Stockholm, Sweden, in 1928. Rolf M. Sievert was one of the founders and later became chairman. The ICRP makes suggestions and recommendations for radiation protection, which are followed in most countries that have established a national protection board.

Since 1928, ICRP has developed, maintained, and elaborated the International System of Radiological Protection used world-wide as the common basis for radiological protection standards, legislation, guidelines, programmes, and practice.

We can mention that the first recommendation is from 1934. People working with radiation should not attain doses above 0.2 R (roentgen) per day. In our dose-system this is about 1.86 mGy to soft tissue per day or about 680 mGy per year. Since then the maximum allowed doses have been smaller and smaller and today the ICRP limits are:



Group	Annual dose
Radiation worker	20 mSv
General public	1 mSv

LNT

The most important aspect with regard to recommendations is that ICRP uses the principle of linear dose-effect-curves (LNT) with no threshold doses to estimate the health effects from small radiation doses. This principle was introduced in the late 1950s and is still the basis for all dose limits recommended.

Back in the 1950s the “target theory” dominated the evaluation of radiation data. It was assumed that the biological result was due to a “hit” – and the number of hits increases linearly with dose. A few years later it was accepted that the initial step for carcinogenesis (the initiation) is a damage to the DNA in a cell. Again the initial number of DNA-damages increase linearly with dose. Thus as long as we can keep the biology with all its defense and repair mechanisms out – it is reasonable to assume the LNT-model.

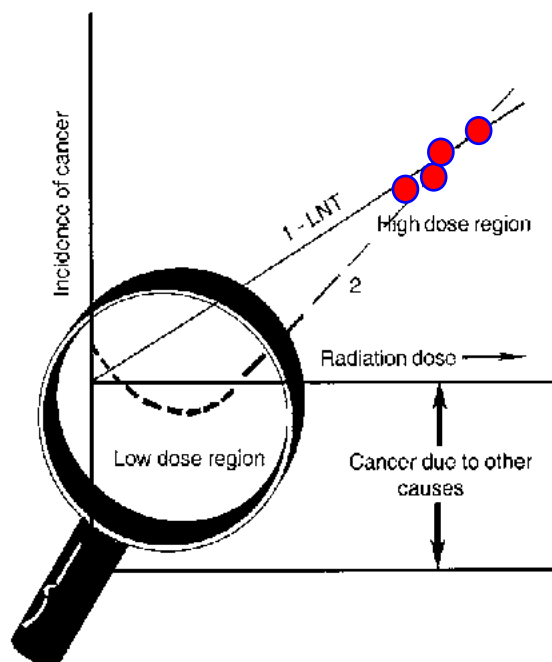

The figure to the left give you an idea of the basics behind the dose-effect curve.

The curve marked 1-LNT is the well known “linear no-threshold model” for radiation damage.

The curve marked 2 has an alternative form, including both a threshold as well as a “hormetic” part for the smallest doses. The filled circles indicate assumed observed data for the large dose region. The two alternatives are drawn to fit observations in the high dose region.

In 1957 P. Armitage and R. Doll published a paper about carcinogenesis. They suggested that the promotion step must be considered to be a stochastic process – i.e. it takes place by chance. From the pool of cells with DNA-damage the cell that is the origin for a tumour is picked out by chance. If radiation was the only carcinogen and if no biology is included, we can use the collective dose conception in risk analysis.



Sir Richard Doll (1912 – 2005) was a British physiologist and epidemiologist. Around 1950 he found a strong correlation between smoking and lung cancer. This was a surprise at the time and Doll was knighted for his work.

ICRP have not included the biological processes with repair and apoptosis that is stimulated by small doses given at a low dose rate and the LNT-model is still used. Thus in the 2007 recommendations we quote:

“The 2007 recommendations of the International Commission on Radiological Protection (ICRP) take account of the latest biological and physical information and consolidate the additional guidance provided by ICRP since 1990. The changes to the scientific data are not substantial. ICRP has retained its fundamental hypothesis for the induction of stochastic effects of linearity of dose and effect without threshold and a dose and dose-rate effectiveness factor (DDREF) of 2 to derive nominal risk coefficients for low doses and low dose rates.”

Based on the above considerations and conclusions the radiation authorities in most countries (including “Strålevernet” in Norway) have used the “*Linear No Threshold*” (LNT) -model for the deleterious effect of ionizing radiation. The model simply assume that all radiation is bad and that the deleterious effect increases linearly with dose with no threshold (start at zero dose). Since zero dose is not attainable the ALARA – principle (As Low As Reasonable Achievable) was introduced.

The risk model chosen by ICRP and the other radiation authorities is excellent for setting up a protection system for all use of ionizing radiation. The ultimate goal is zero dose. Furthermore a linear dose-effect curve makes it possible to use collective doses and opportunities to calculate the detrimental effects to an irradiated cohort.



Risk estimates are based on the form of the dose-effect curve – and is by definition the steepness (the derivative) of the dose effect curve.

$$\text{Total risk} = \text{risk factor} \cdot \text{dose}$$

For a straight line this implies a constant risk factor (independent of dose)!

The calculated total effect using the LNT-model is the product of the risk factor and the collective dose. Such simple calculations have been extensively used and have attracted the interest of the public. For all other forms of the dose-effect curve, however, risk calculations are far more complicated and, for the most part, impossible.

All regulations with regard to radon in houses, radioactivity in the drinking water, radioactivity in food products after Chernobyl have been set in line with the LNT-theory. **All these regulations are very costly.**

If we take biology into account

As long as we only are concerned about physical processes with radicals and DNA-damage the linear dose-effect curve is expected. However, we have seen in Chapter 12 that when living cells are irradiated a number of biological processes are initiated that will strongly influence the end result such as the induction of cancer. In particular the research during the last two decades are very interesting and show that small doses of radiation given at a low dose rate stimulate the defense mechanisms.

We can safely conclude that: **“the LNT-model is not valid”**. In fact, small doses are necessary for life.

Radiation hormesis

During the last years a lot of research show that small doses of radiation are beneficial to life. We shall first mention an experiment carried out with *Paramecium*.

Planel and coworkers (1987) studied the growth of *Paramecium* (the small “slipper shaped” cells living in water) by carrying out the following experiments:

A. Cultures of paramecium were put into a 5 to 10 cm thick lead chamber that reduced the background radiation to almost zero. The result was that cell growth was reduced. The same result was obtained when the experiment was carried out in an underground laboratory where the radiation background was very small.

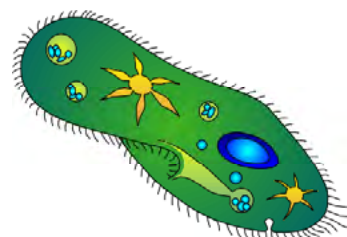

A drawing of *Paramecium*

B. The next step in the experiment was the introduction of radioactive sources.

The radiation from the sources resulted in a radiation level which yielded an annual dose of from 2 to 7 mGy (comparable to normal background radiation). The result was that the cell growth increased back to “normal.” These and similar experiments indicate that small doses of radiation may stimulate a number of processes such as cell growth and cell repair.

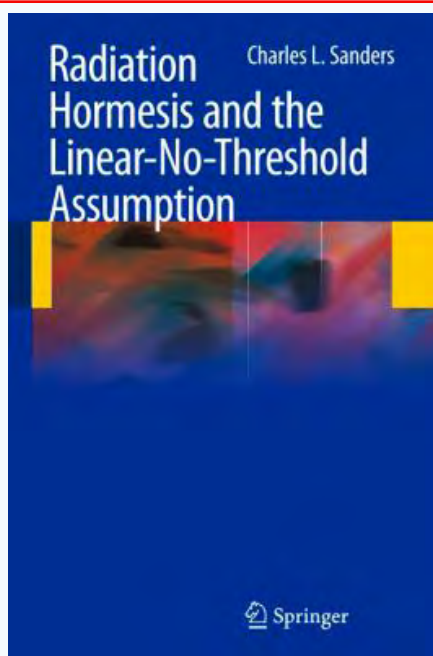

In 2009 Charles Sanders published the book **“Radiation Hormesis and the Linear-No-Threshold Assumption.”**

We quote from the introduction to this book

“Ionizing radiation is considered to be a weak carcinogen. Negative uncertainty about carcinogenic effects from ionizing radiation have influenced decommissioning of the existing nuclear facilities, long-term storage for reactor waste, construction and placement of new nuclear power plants, increased fears of “dirty bombs,” and utilization of diagnostic radiology to find and treat disease. The decades-long moratorium on new construction of nuclear power plants in the U.S., a pervasive resentment of anything “nuclear,” and a delay or refusal to obtain needed medical radiation exposures are some of the societal consequences to radiophobia among the American public.

While regulatory decision making was designed to protect the public health, in some ways it has become punitive and burdensome. The idea that any exposure to radiation may be harmful has led to public anxiety and enormous economic expenditures that are disproportionate to the actual radiation risks involved. In the United States and some other countries, regulatory compliance costs are steadily growing, while desired public health benefit from added regulation are increasingly difficult to measure.

A position paper of the Health Physics Society calls the regulatory systems for determining and enforcing public health standards “inconsistent, inefficient, and unnecessarily expensive”.

For those interested in the vigorous discussion going on with regard to the LNT-theory should also read the summary article from 2000: “*It’s Time to Tell the Truth About the Health Benefits of Low-Dose Radiation*” by James Muckerheide.

<http://www.21stcenturysciencetech.com/articles/nuclear.html>

"only nuclear power can now halt global warming"

The English environmentalist James Lovelock (2004)



Chapter 14

Nuclear power – Environment – Climate

The time is ripe for increased use of nuclear energy

The climate debate as well as the demand for more energy to sustain and improve the living for an increasing world population, has called for a new discussion on nuclear energy.

Today, about 85 % of the worlds total energy production is from fossil energy sources, which result in an increase in the atmospheric CO₂ content of about 2 ppm per year. If this increase in CO₂ content continues, it will result in climate change and a warmer world. The main part of the discussion (at least the political) have been concerned about CO₂ capture and storage. The problems are enormous and up to now the CO₂ release has only increased.

The world energy use has increased exponentially during the last 150 years. Today the increase is 1.8 % per year. One possible solution is to use other energy sources with small or none release of CO₂. This implies that the new power plants, as far as possible, should not be based on fossil fuel.

In the illustration to the right we give you a glimpse of the world electricity production in 2008. Of the renewable energy sources, hydroelectricity is the most significant, and contribute with about 16 % of the production. Wind energy is increasing by almost 30 % per year and contributed (in 2010) to about 2.5 % of the world electricity production. Solar energy contribute very little, at least up to now.

In the illustration for 2008 the nuclear reactors contribute with about 13.4 % of the electricity production. Nuclear power has got a bad reputation, mainly because of the fear for radioactivity and its radiation. Nuclear power give waste and include also the risk for reactor accidents. The public and political lack of knowledge in radiobiology have resulted in fear for cancer and other detrimental health effects from radiation. This is the main reason for turning the “thumb down” for nuclear power.

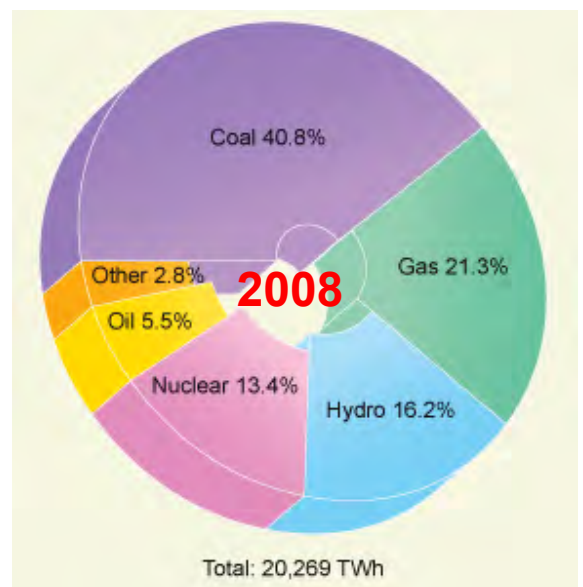

For all those who have read this book, in particular chapters 12 and 13 may have a different view on radiation and its effects. Thus, we have learned that small amounts of radiation would stimulate our defence mechanisms and protect us against cancer. In fact, the results of the last 20 years of research within radiation biology is a large stimulation to new enthusiasms for nuclear power compared to fossil fuels.

The beginning of nuclear power

The Italian physicist Enrico Fermi started the first nuclear reactor on December 2, 1942 in Chicago. He then opened for a completely new energy source. The first day, the reactor operated for 4 minutes with an intensity of half a watt.

Since this successful start, reactors have been built, for the production of plutonium used in atomic bombs, for research (like the Kjeller reactor in Norway in 1951), and for electric power. And power generation is the subject for this chapter.

During the first years after the war, the optimism was large for using nuclear power for boats, in particular submarines since a reactor does not require oxygen that is particularly important for a submarine.

Nuclear reactors have been built for electricity production. Different design and protection schemes have been used. Today an ordinary reactor very often has a power of up to about 1300 – 1500 MW. With full drift through the year, a reactor with this power may give about 10 – 13 TWh, which is a significant contribution..

In January 2012, 435 nuclear reactors in 31 countries contribute with a net electric capacity of about 368 GW. Furthermore, 63 plants with a capacity of 61 GW are under construction. The contribution from nuclear power to the electricity production varies largely from one country to another with France on the top. Nuclear power increased up to about 1986 (the Chernobyl accident), and has for the last 25 years contributed by 14 – 16 % of the world electricity production.

Before we embark on the basic physics for nuclear power, we shall stop for a moment on climate ideas and compare the energy resources for nuclear power with the renewable sources such as wind power.

Nuclear power and climate

Nuclear power does not release CO₂ – and will not contribute to climate change. This fact must be a dream to most environmentalists and the famous English environmentalist James Lovelock (known from the book «Gaia») express his view in 2004 as follows: ***“only nuclear power can now halt global warming”***.

In his view, nuclear energy is the only realistic alternative to fossil fuels that has the **capacity** to both fulfill the large scale energy needs of humankind while also reducing greenhouse emissions.

Another well known scientist James Hansen (former director of NASA Goddard Institute for Space Studies, GISS) strongly support research and use of nuclear energy.

However, the large majority of environmentalists and politicians do not support Lovelocks and Hansens view. The downward trend for nuclear energy started with the reactor accidents; ”Three Mile Island” in 1979, Chernobyl in 1986 and Fukushima in 2011.

During the last 25 years environmentalists, and the general public have considered the negative effect of radiation to be too large, and nuclear energy has not been considered in the climate debate.

We know that radiation is a carcinogen in large doses. However, in the case of the radium workers (particularly the dial painters we discussed on page 274– 276) cancer occurred only for doses above 10 Gy. A large amount of information exists on the benefits of living in high dose areas in Iran, Brazil and the dramatic effect for the Taiwan cohort (page 281). Also the clean up workers after Chernobyl seem to benefit from the extra radiation (page 166).

However, the radiation authorities in all countries follow the guidelines from ICRP, assuming a linear correlation between radiation dose and cancer (the LNT-model). These false guidelines have hampered the use of nuclear power for many years. Most people consider nuclear power to be too risky – and would rather use other energy sources like fossil fuels, and of course the renewable sources, like wind and solar power.



Enrico Fermi

Wind and solar energy is very popular – however, the drawback is that they both contribute, very little. Both the capacity is small and the fact that you can not turn on and off these sources after demand makes it so far difficult. Thus, in Norway, wind power contributed with 0.98 TWh in 2010 (less than 1 % of the electricity production).

The countries with the highest contribution from wind is (in 2010) Denmark (21 % of the electricity production), Portugal (18 %), Spain (16 %) and Germany (9 %). The total installed capacity in the world (2010) was 196 GW. According to the plans this will increase to 1500 GW in 2020.

A few words are necessary in order to give a correct picture of the wind power and the relation between installed capacity and power output, which of course is extremely dependant upon the wind speed (the average wind speed through the year). Let us therefore compare wind power with nuclear power in the following way.

Wind power versus nuclear power

Nuclear. We assume a modern nuclear reactor with the power of 1500 MW. The reactor can run at this power almost the full year and produce 12 – 13 TWh. Furthermore, a nuclear reactor can be turned on and off according to demand.

Wind. The power in the wind is converted to electric power in a mill. We must have a large windmill park in order to give the power of the reactor mentioned above. Wind power depend on the wind speed and the size of the rotor.

The power production from a wind mill is calculated in the following way using the figure below for explanation: The energy available is the power of the airmass (m) hitting the rotor with the speed v (wind speed). The energy is given by $E = \alpha(1/2 mv^2)$. Here α indicates which fraction of the total energy passing through the rotor disk that is transmitted to the rotor. According to Betz' law it cannot become larger than 0.59. Modern turbines reach 70 – 80% of this limit – and α is 0.40 – 0.45.

Using the figure we see that the mass hitting the rotor per second is the air in the cylinder with the area πR^2 and the length v (R is the rotor radius and v is the wind speed).

We get the following expression:

$$E = \left(\frac{1}{2} \pi R^2 \cdot \rho \cdot v^3\right) \cdot \alpha$$

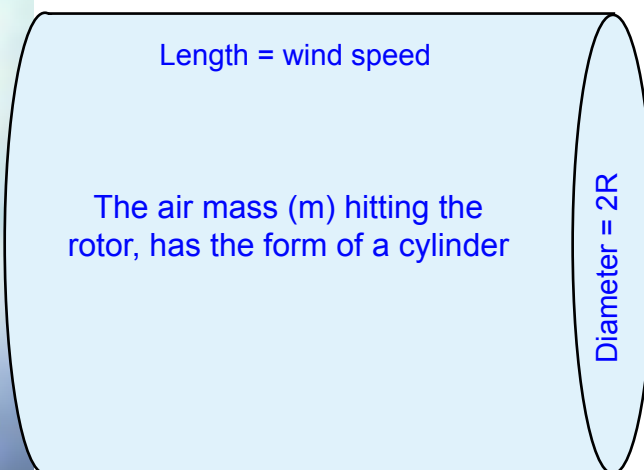

An illustration which shows the airmass hitting the rotor of the mill per second. The air mass has the form of a cylinder with the length equal to the wind speed – and the diameter is equal to the diameter of the rotor.

We can use the formula to calculate the capacity of a windmill. In the formula ρ is the density of air (at sea level it is 1.23 kg/m^3).

The efficiency factor of the windmill, α , is set to 0.45 (about 75 % of the theoretical maximum). The energy increases with the cube of the windspeed. We can use a windmill for windspeeds from 4 m/second up to a maximum of 14 – 15 m/s. Higher wind speeds will not increase the power and the mills are stopped for wind speeds above 20 m/s.

The “capacity” of a mill is calculated for a wind speed of 12 – 15 m/s. The rotor diameter has increased in the recent years from 60 to about 100 m. The maximum diameter (2012) is 123 m and the height of the mill is 135 m. The capacity of this mill is therefore approximately 9 MW.

For a rotor of 100 meter diameter, the capacity is about 6 MW. If we have a wind speed of 12 – 15 m/s through the year, the annual energy output of the mill, running all the time, would be 52 GWh (0.052 TWh). However, we have to assume normal wind speeds which are much smaller and of course variable. Consequently, the annual power output is of the order 20 – 40 % of the theoretical value.

An example. Smøla wind park consists of 68 windmills with a capacity of 150 GW and produces annually 356 GWh, whereas the theoretical maximum is 1314 GWh (a factor 3.6 larger). The average wind speed in Smøla is 8 m/s. The same holds true for Hitra with another wind park. The wind speed is measured 50 meter above ground.



For offshore wind parks the wind speed is of the order 10 – 12 m/s – and would probably be a better choice. On the west coast of Norway the pilot project with Hywind consists on a windmill with rotor diameter of 82 m. in diameter. The capacity is 2.3 MW and in 2010 the producyion was 7.3 GWh – somewhat better than the Smøla windmills.

If we compare the windmills with a nuclear reactor we can conclude that we must have at least 1000 Hywind mills or extent Smøla windpark to include more than 1600 units to give the same annual energy production.

In order to prevent disturbances in the wind field the mills must be placed about 3 rotor diameters (or more) from each other. This implies that Smøla wind park must increase to about 450 km^2 – double the area of Smøla (214 km^2)!

Wind energy has also another problem – you attain energy only when the wind blows – you can not turn a knob when you need energy. Furthermore, we would like to have a system to save energy when the production is larger than the use.

In conclusion. It is possible to use wind power. However, we need systems for storing. Even though new windparks are constructed more and more, it would take time before wind energy represents a solution to the energy demand in the future.



Energy from the atom

Fission - Fusion

Some of this is also presented in Chapter 4 (page 38–42) and in Chapter 8.

Nuclear power is based on the two physical processes called fission and fusion. Today only the fission process is used for energy production, but hopefully fusion may be used in the future.

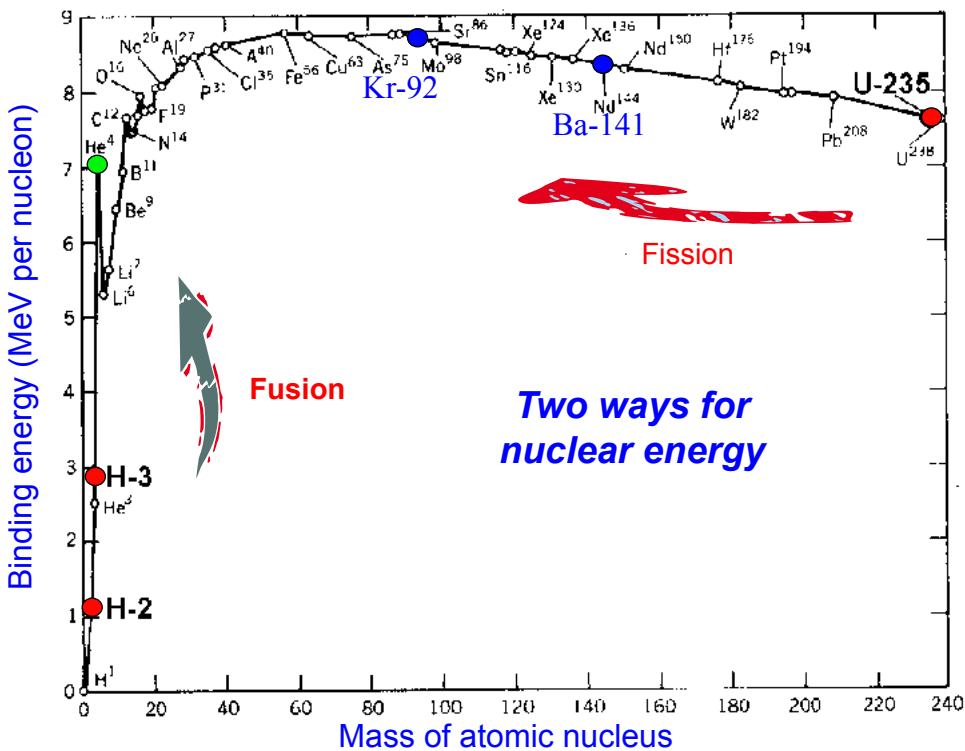

The two processes can be explained using the figure to the left. The figure gives the binding energy in the atomic nucleus. Energy can be gained if we can transform a nucleus with a small (or at least lower) binding energy into a nucleus (or nuclei) with a larger binding energy.

Protons and neutrons are kept together by strong forces in the atomic nucleus. Along the vertical axis is given the binding energy per nucleon (mass unit). The figure says that the binding energy increases from about 1.1 MeV (for deuterium) to about 8.8 MeV (for iron). It decreases again toward heavier atoms such as U-235.

Along the vertical axis is given the “binding energy” per nucleon, and along the horizontal axis is given mass number. You gain energy by going from a nucleus with low binding energy into one with a larger binding energy.

It is possible to gain energy by transforming a nucleus with a small binding energy to another with a larger binding energy.

Thus, the gain is about 24 MeV when two deuterium atoms combine to form helium (He-4) or about 17 MeV by a fusion of H-2 (D) with H-3 (T). Upon a fission of uranium into Kr-92 and Ba-141 the gain is approximately 203 MeV (the red U-235 into the blue nuclei in the figure).

In conclusion: There are two possibilities for energy production from the nucleus:

1. Fission. A large atomic nucleus is split into smaller units. From the curve above it requires that a heavy nucleus (to the right) be fissionable. Atoms that are fissionable are the isotopes U-233, U-235 and Pu 239. We shall return to these isotopes and the use of them. The energy released in the process is about 200 MeV – and about 170 MeV goes into kinetic energy that can be used for power generation.

2. Fusion. Energy is gained in a fusion process. The requirement is that light atoms with a low binding energy are used. Hydrogen, deuterium and helium are all atoms that can be used for fusion. The fusion process requires a very high temperature (several million degrees) and is the main energy source for the sun. So far, a controlled fusion process with gain of energy has not been achieved. In order to reach the high temperatures, high energy lasers have been used. At present, an international cooperation has started to build a tokamak in Provence, France called ITER (International Thermonuclear Experimental Reactor) which hopefully will be tested in about 2019. The plans are that the reactor will give an output of about 500 MW for an input of 50 MW.

Fission and fissile material

The reader should also consult the pages 125 – 126 in chapter 8.

The power reactors used today are based on fission and thermal neutrons. Even though, we shall not go through the technical aspects, we can explain some of the basic principles. In the illustration to the right the fissile element U-235 fissionate into two new elements; Kr-92 and Ba-141. A slow (thermal) neutron initiate the reaction. The reaction also gives 2 – 3 new neutrons with an energy of about 2 MeV (fast neutrons).

Fissile elements

The fuel for fission reactors is the fissile atoms; U-235, Pu-239 and U-233. Only U-235 is found naturally. The two other fissile elements must be produced. In the table below we see some of the properties for the fissile elements and for the fertile elements U-238 and Th-232.

Isotope	Half-life in years	% Abundance
U-235	$7.13 \cdot 10^8$	0.72
U-233	$1.62 \cdot 10^5$	0
Pu-239	24400	0
U-238	$4.51 \cdot 10^9$	99.27
Th-232	$1.39 \cdot 10^{10}$	100

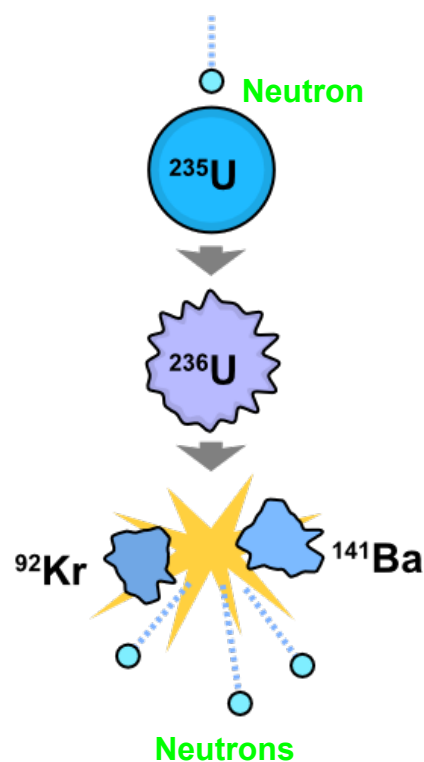

If nuclear energy should be based only on U-235 the resources are rather limited. However it is possible to start with the fertile elements and convert them into fissile ones. The following nuclear reactions are necessary:

Pu-239

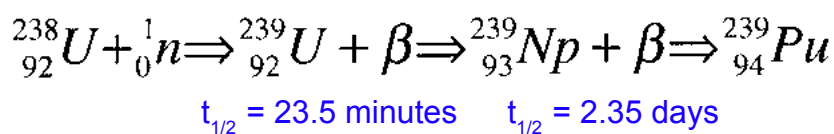

U-233

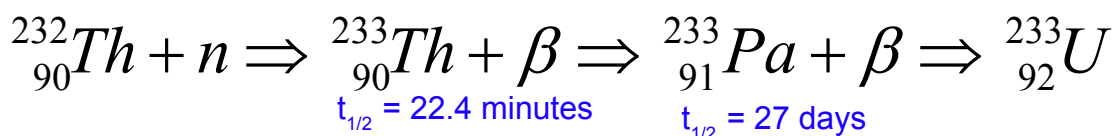

Conclusion

Three different isotopes are fissile. As you see in the table above only U-235 can be found in nature. In order to use the nuclear resources for power production we must enrich U-235 and/or transform the isotopes U-238 and Th-232 into the fissile ones.

Enrichment of U-235

Most power reactors with U-235 are based on enrichment of U-235. We have “*Slightly enriched uranium*” with a U-235 concentration of 0.9% to 2%, “*Low-enriched uranium*” which has a U-235 concentration lower than 20% and finally “*Highly enriched uranium*” with a U-235 concentration greater than 20%.

Nuclear weapons usually contains 85% or more of U-235. The Hiroshima bomb contained U-235 to a concentration of 80 %.

The different isotopes are, of course, chemically equivalent and the separation methods are based on the physical differences such as the weight. Gas diffusion and gas centrifugation are used.

The Oklo reactors – a result of a higher U-235 concentration

When Enrico Fermi started the first man-made reactor under Stagg Stadium in Chicago in 1942, everybody assumed that this was the first reactor. However, in 1972 the French physicist Francis Perrin discovered that nature itself had beaten Fermi by approximately 2 billion years. They reported that in Gabon in Africa there was, once upon a time, *natural fission reactors* that operated for several thousands of years.

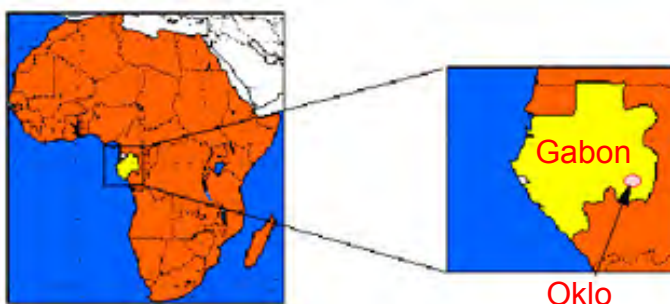

Some exciting work led to the discovery of the Oklo phenomenon. In the samples from Oklo the amount of U-235 was smaller than the expected 0.72 %. In some samples, hardly more than 50% of that expected, was found. The conclusion, after a long series of tests, was that U-235 had been “burned up” in the same way as in an ordinary fission reactor.

The reactor in Oklo was formed about 2 billion years ago. At that time the amount of U-235 was about 3.6 % (today it is only 0.72 %). Using the data on the half-lives in the table above you can calculate the U-235 concentration to any time you want. If you choose $2 \cdot 10^9$ years ago the concentrations of the two isotopes were 3.6 % U-235 and 96.4 % U-238. Consequently, the amount of U-235 was approximately like that found in an enriched reactor.



Francis Perrin
(1901 – 1992)

In order to maintain the fission the energetic neutrons formed must be slowed down to thermal energies. In Oklo the moderator was water bound to the minerals.

About 15 reactors were buried in the Oklo uranium mine. They generated about 100 kilowatts for about 150,000 years. Groundwater evaporation and condensation kept them on a cycle that prevented meltdowns!

Fission products were formed, but the radioactive isotopes disappeared a long time ago. The stable end products can still be found. A very interesting result, with regard to storage of radioactive waste, is that the fission products have not moved significantly in the course of 2 billion years.

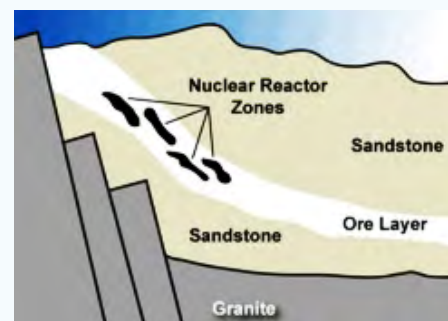

The plutonium (Pu-239) formed in the Oklo-reactor was slowly transformed to U-235 (α -decay), which then went into the burning cycle.

Today the occurrence of U-235 is too small for any new natural fission reactors. The Oklo-phenomenon will not reappear, but the uranium mines in Gabon have yielded a number of interesting facts.

Formation of the fissile isotopes Pu-239 and U-233 (reactor fuel)

Whereas U-235 exists in nature and can be used after enrichment – the two other fissile elements have no natural sources and can not be gained by enrichment. However, the other possibility is to form (or breed) these isotopes. **The requirements are the fertile materials, U-238 and Th-232, and a strong neutron source.**

A strong neutron source is available in a reactor. The fission process liberates 2 – 3 neutrons with high energy. In average one of these neutrons can be used for a sustained fission process and the rest can then be used to produce new fissile elements. If a neutron is absorbed by U-238 the result may be Pu-239. Consequently, Pu-239 is all ways formed as a byproduct in a reactor. We can use this Pu-239 as fuel in a fission reactor.

We have also the possibility to increase the formation of both Pu-239 and U-233 in a reactor – such as a “**breeder reactor**”. In a breeder reactor the neutron economy is high enough to breed fissile from the fertile materials U-238 and/or Th-232. This would increase our energy sources and satisfy our energy needs for as long as we can see into the future.

Breeder reactor

We have two types of traditional breeder reactors:

1. **Fast breeder reactor** or FBR. Here the neutrons are not slowed down – they are fast. The initial fuel is enriched U-235 (enrichment of about 20 %) and Pu-239. The core has a “fertile blanket” of depleted uranium (U-238), and this is where much of the Pu-239 is produced. Neutron activity is very low in the blanket, so the plutonium produced there remains almost pure Pu-239 - largely not burned or changed to Pu-240. The blanket can then be reprocessed and the plutonium recovered for use in the core. Fast reactor concepts being developed for the Generation IV program will simply have a core so that the plutonium production and consumption both occur there. Many interesting plans exists and new reactors will be built in the years to come. India is now on the point to try out a fast breeder reactor and use thorium for this purpose.

2. **Thermal breeder reactors.** The excellent neutron capture characteristics of U-233 make it possible to build a moderated reactor that, after its initial fuel charge of enriched uranium, plutonium or MOX, requires only thorium as input to its fuel cycle. Th-232 produces U-233 after neutron capture and beta decay.

ADS. Another possibility to form fissile U-233 is the “**accelerator driven system**” as suggested by Carlo Rubbia.

In this case accelerators are used to produce neutrons from heavy elements by spallation. A beam of high-energy protons (usually >500 MeV) is directed at a high-atomic number target (e.g. tungsten) and neutrons are formed by spallation.

An ADS can only run when neutrons are supplied to it because it burns material which does not have a high enough fission-to-capture ratio for neutrons to maintain a fission chain reaction.

Therefore we have a nuclear reactor which could be turned off simply by stopping the proton beam, rather than needing to insert control rods to absorb neutrons and make the fuel assembly subcritical. Because they stop when the input current is switched off, accelerator-driven systems are seen as safer than normal fission reactors



Carlo Rubbia

The Nobel Prize in Physics 1984 was awarded jointly to Carlo Rubbia and Simon van der Meer:

“for their decisive contributions to the large project, which led to the discovery of the field particles W and Z, communicators of weak interaction”.

Conclusion

We do not intend to go into reactor technology – you can find all the principles and problems on internet. **World Nuclear Association** publish information and updates on the following address:

<http://www.world-nuclear.org/infomap.aspx>

and

<http://www.world-nuclear.org/info/inf62.html>

Resources

The resources for fission energy is uranium and thorium. Let us first mention a little about the history of these two elements.

Uranium

The element was discovered in 1789 by the German chemist Martin Heinrich Klaproth. The name is from the planet Uranus. Uranium is element 92 and has altogether 14 isotopes, all radioactive.

Due to the half-lives only U-238 and U-235 can be found in nature.

Today U-238 accounts for 99.27 %. It is not fissile, but can be transformed to Pu-239 and used for reactor fuel. Uranium is a relatively common element, approximately as common as tin or zinc, and it is a constituent of most rocks and even of the sea.

As we know it today the largest sources are found in Australia (31%), Kazakhstan (12%), Canada (9%), Russia (9%). South Africa, Namibia, Brazil and Niger has about 5 % each.

Since only 0.72 % is U-235 the resources are not too large. Some estimates indicate that with the present use the resources would last about 100 years. However, if U-238 can be used in future reactors the resources would last several thousand years.

Thorium

Thorium was discovered in 1828 by the Swedish chemist Jöns Jakob Berzelius. The name is from the god Tor. Thorium is element 90 and has 13 isotopes – all radioactive. Only Th-232 is found in nature. The isotope is not fissile, but can, as shown above, be transformed into the fissile isotope U-233.

The resources are very large (three times larger than uranium) and would last for thousands of years.

The most common source of thorium is the rare earth phosphate mineral, monazite, which contains up to about 12% thorium phosphate, but 6-7% on average. Monazite is found from rocks of molten magma and other rocks, but the richest concentrations are in sand deposits, concentrated by wave and current action with other heavy minerals. World monazite resources are estimated to be about 12 million tonnes, two-thirds of which are in heavy mineral sands deposits on the south and east coasts of India.

Thorite (ThSiO₄) is another common mineral.



Martin H. Klaproth
(1743 – 1817)



Jöns Jakob Berzelius
(1779 – 1848)

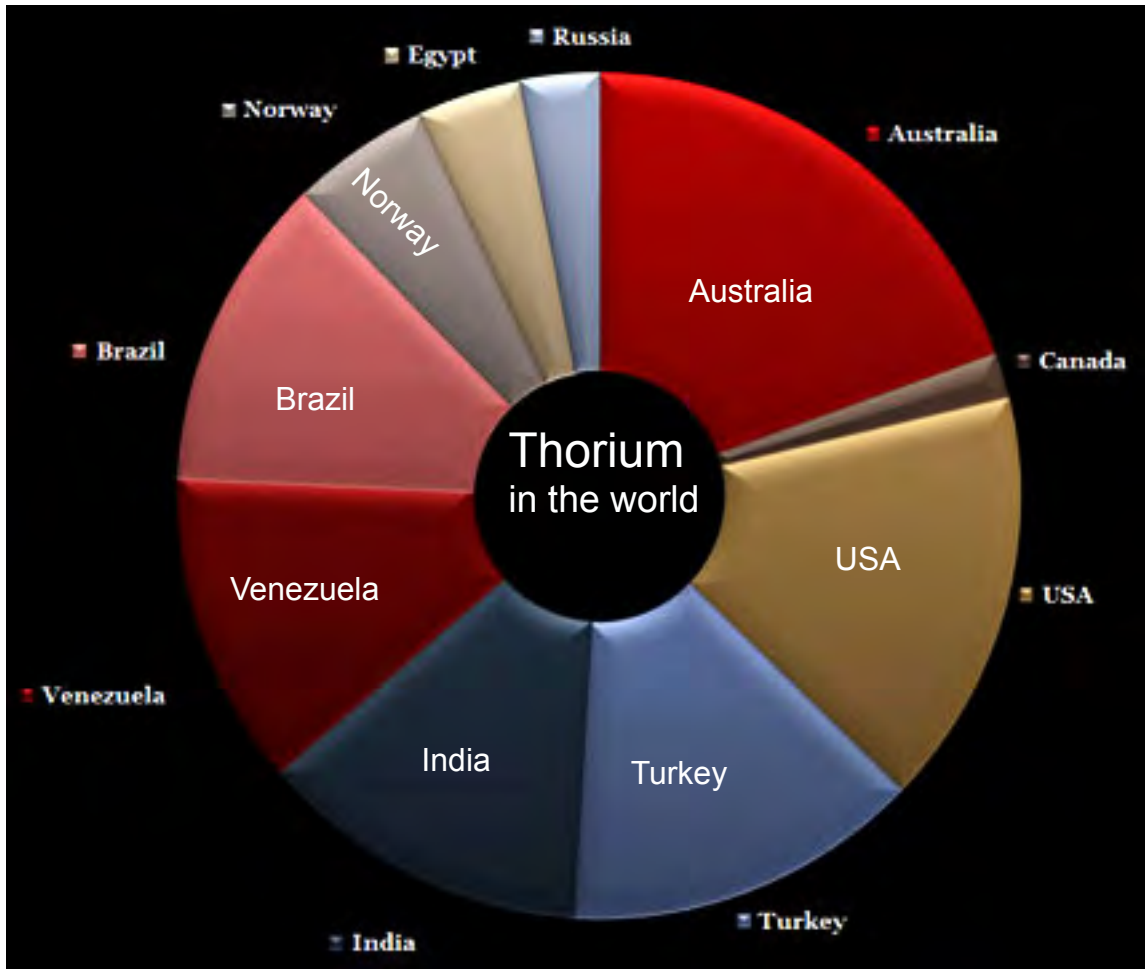

In this illustration is given the distribution of the world resources of thorium (explored so far). Only the sources that are cheapest for thorium production are taken into account. The limit is that thorium should be recovered at a price of less than 80 dollar per kg (2007).

Thorium in Norway

As seen in the illustration above Norway has a considerable resource of thorium. Most of it is found in the Fen Complex in Telemark. It is assumed that the thorium resources have a potential energy content which is about 100 times larger than all the oil extracted to date by Norway, plus that of the remaining reserves.

The interesting Fen complex originate from a volcano about 500 million years ago. The field is almost cylindrical and the crystallization occurred 2 – 3 km below surface. It has been found a lot of “rare earth elements” and it has been mining in the area for iron (period 1657 – 1927) and niobium (1953 – 1965). Furthermore, the radioactivity is quite large and demonstrates both thorium, uranium and potassium.

Several geological investigations has been performed in recent years. Here we would like to mention the studies on thorium.



The search for radioactivity in the air and on the ground are based on the γ -radiation. Thorium and uranium are pure α -emitters whereas a number of the daughter elements yield γ -radiation. With a good γ -spectrometer with high energy resolution it is possible to sort out the isotopes. A nice example is shown on page 76 where the isotopes from the Chernobyl accident were identified in a grass sample outside the Physical institute in Oslo. In order to identify thorium and uranium based on radioactivity the isotopes in table below is used.

Compound	Isotope used	Half-life	Gamma-radiation
Thorium	Tl-208	3.1 min	2.61 MeV
Uranium	Bi-214	19.7 min	0.61 MeV
K-40	K-40	$1.27 \cdot 10^9$	1.46 MeV

In 2007 an area of about 20 km² of the Fen Complex was observed with a γ -ray spectrometer with a sodium iodide detector connected to a helicopter. To ensure a uniform and dense data coverage, the measurements were performed along parallel lines with a narrow line spacing of 50 m. The average flying altitude during the measurements was 45 m. Maps of the three elements were produced. The thorium map is shown below.

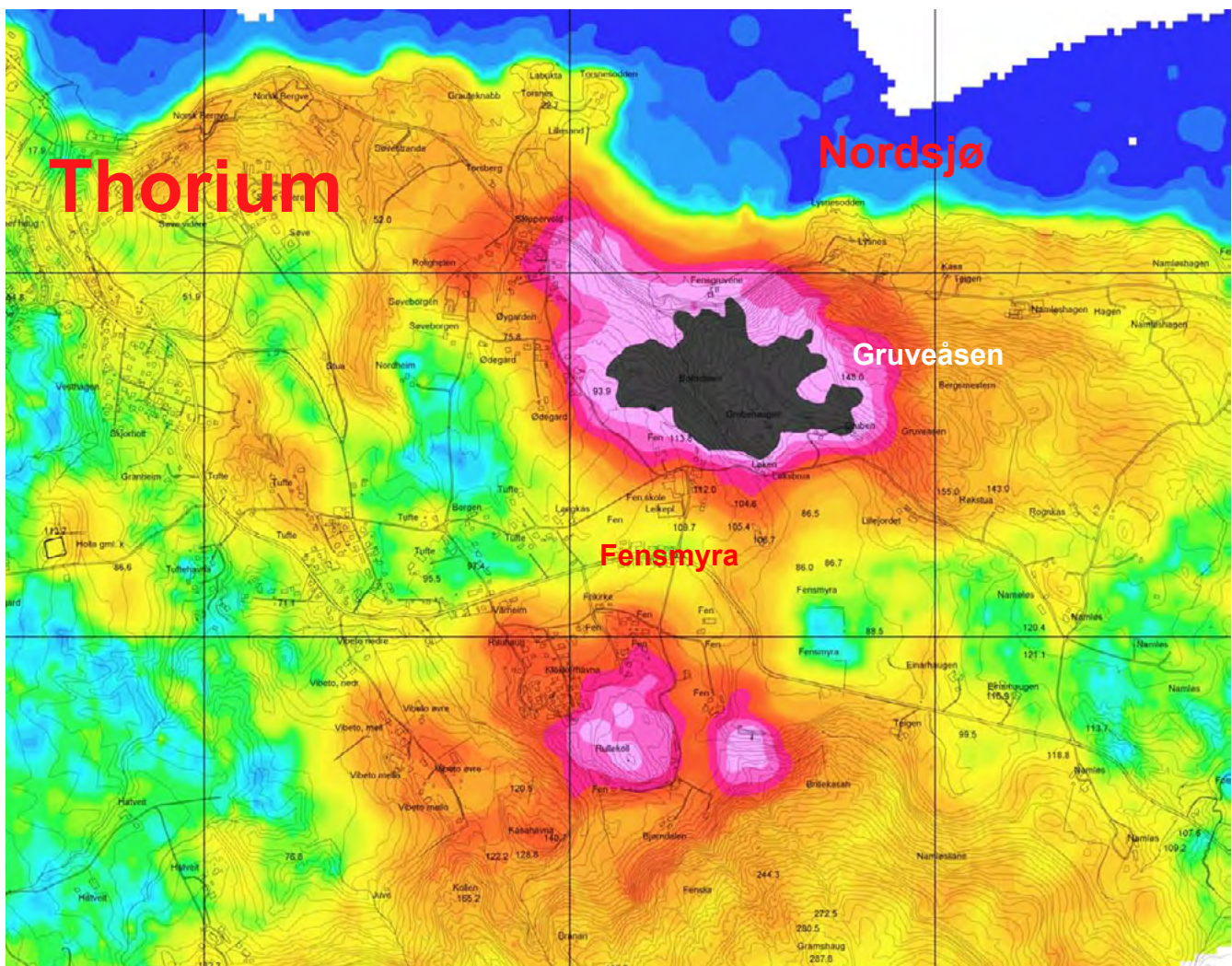

The field map showing the thorium density in the Fen complex. The concentration is given by colors – the more red and violet the larger concentration of thorium. Large areas of the field is covered by sediments that varies from centimetres to several meters which effectively absorbs the γ -radiation. Consequently, the measurements in this area (Fensmyra) may be considerable larger than shown by the helicopter measurements.

Nuclear power – Climate

We shall discuss a few points concerning nuclear power and climate. The discussion include energy resources, waste disposal (CO₂ release versus radioactivity), accidents and consequences for the landscape. We shall not include economy since this factor will change with time.



Energy

First of all we would like to mention the very large content of energy in the atomic nuclei that can be released by fission and fusion. We mentioned above that a splitting of a fissile nucleus yield about 200 MeV – and about 170 MeV is available for electricity production.

Today about 80 % of the world energy production comes from fossil fuel. The resources of oil is limited and with the present use it will last for about 100 years at an increasing cost. Coal sources are larger and will last for a long time.

Let us now compare nuclear energy with fossil fuel. The energy produced from burning 1 kg wood, coal and oil can be compared to the energy produced by the fission of 1 kilo of the fissile atoms such as U-235 or U-233. Included in the table below is also the energy content by fusion of 1 kg hydrogen (the energy production in the sun).

The data are given in the following table.

Source	Method	Energy in kWh
1 kg wood	Burning	5.3
1 kg Coal	Burning	7.8
1 kg Oil	Burning	10.7
1 kg U-235	Fission	$20 \cdot 10^6$
1 kg Hydrogen	Fusion	$190 \cdot 10^6$

The table show that burning 1 kg of wood is equivalent to run an electric heater of 1000 watts for 5.3 hours. Coal and oil have more energy. However, using 1 kg of fissile materials is equivalent to use the 1000 watt heater for 20 million hours or about 2283 years.

Nuclear energy from fission has been used during the last 50 years and has accounted for about 14 – 16 % of the world electricity production during the last 25 years. Now the time is ripe to increase the use of nuclear energy.

Arguments in favor of nuclear energy

1. No release of CO₂ which is the main argument against fossil fuel.
2. The large amount of research during the last decade which show that small doses of radiation given at a low doserate have a beneficial effect on the cells defence mechanisms. This show that small doses of radiation is necessary for life. Our fear for nuclear accidents and nuclear waste are strongly exaggerated.
3. The use of thorium and fast breeder reactors can give waste with a shorter halflife.

Fossil fuel waste. CO₂ capture and storage

In the case of fossil fuel the waste such as CO₂ is not harmful for living organisms. In fact CO₂ is a necessary component for photosynthesis as well as for living cells.

However, **all climate models show that the greenhouse effect increases with the CO₂ content** (not linearly, but rather in a logarithmic way). Consequently, environment-organisations and the political establishment in the industrialized countries have for some years now explored the idea of capture and storage of CO₂. If this would be possible it would require a significant reduction of the energy produced and available for use, because some part of the energy must be used for CO₂ capture and another part for storage.

Since CO₂ is stable the storage must be permanent – with no leakage.

Nuclear waste

The storage of nuclear waste has very strong regulations. Today all regulation authorities assume that the detrimental effects of radiation follow the LNT model – and all countries have implemented an extremely conservative system for nuclear waste.

Throughout this book we have questioned the LNT-hypothesis and the research during the last 5 years have clearly shown that it is not valid. These research data will sooner or later change our view on the danger with radioactivity and change the rules and regulations used today.

Accidents

Nuclear energy is very safe compared to coal, oil and even hydroelectricity. All opponents to nuclear energy talk about the accidents and the late effects of the released radiation. It seems to be enough only to mention the name Chernobyl. We have through this book treated the Chernobyl accident several times and the conclusion is as follows:

1. Approximately 135 were hospitalized with acute radiation syndrome and 28 died within 96 days.
2. More than 300 000 were permanently replaced. This evacuation was a great mistake and this cohort had a lot of psychological problems including suicide and cardiovascular diseases.
3. It appears that the cleanup workers (at least the group from Russia) that got measurable radiation doses have less cancer and appear to be healthier than the other Russian groups. This would be in line with the new results in radiation biology.
4. Experiments within a region with a large fallout indicate that the ecological half-life for Cs-137 was 3.6 years during the first 6 years after the accident and then increases to almost the physical half-life after 20 years (see the data on page 154). It would be of interest to observe similar results from other regions.

We can conclude that the detrimental health effect is very small – whereas the psychological effects were extremely high and initiated by the LNT-model and supported by environment organizations and lack of knowledge among politicians.

Terror actions

From time to time terror actions against nuclear power stations have been mentioned as an argument against nuclear power. It is possible to carry out terror actions to all systems, but the danger for pollution by radioactive isotopes is extremely small. Terror actions against hydroelectricity dam-projects would be far more dangerous.

Closing Remarks

The purpose of this book is to provide information about ionizing radiation, its use and its consequences. We have provided information about the applications of radiation that benefit society and the different parameters that must be considered for the use of radiation technology in medicine, research, and industry.

For the years to come it would be very important with education and research. It would be a great job to give information about the positive effect of ionizing radiation – but not impossible.

Most people not only accepts the use of radiation within medicine and are eagerly interested in new methods such as CT and PET. Most people accepts the use of radiation in cancer therapy. However, LNT and the radiation authorities have scared the people to be afraid of radon in houses, radioactivity in the drinking water and of course nuclear power.

In this book we have given some information on the positive use of radiation. We have identified risk factors for radiation and it should be possible to establish new rules and regulations to limit detrimental effects and enhance the positive effects both to the individual and to the society.

